

P7B Drive/Bypass Technical Manual

*This Manual
also available on
www.drives.com*



Model: P7B

Document Number: TM.P7B.01

Quick Reference for Bypass Parameters

Parameter Number	Factory Setting	User Setting	Parameter Number	Factory Setting	User Setting	Parameter Number	Factory Setting	User Setting	Parameter Number	Factory Setting	User Setting
A1-00	0		b5-04	100		E1-05	240V or 480V		L1-05	0.2	
A1-01	2		b5-06	100		E1-06	60		L2-01	2	
A1-03	0		b5-07	0		E1-07	3		L2-02	0.1	
A1-04	0		b5-08	0		E1-08	18		L2-03	0.1	
A1-05	0		b5-09	0		E1-09	1.5		L2-04	0.3	
A2-01			b5-10	1		E1-10	10.8		L2-05	190	
A2-02			b5-11	0		E1-11	0		L3-01	1	
A2-03			b5-12	0		E1-12	0		L3-02	120	
A2-04			b5-13	0		E1-13	0		L3-04	1	
A2-05			b5-14	1		E2-01	kVA Dep.		L3-05	1	
A2-06			b5-15	0		E2-03	kVA Dep.		L3-06	120	
A2-07			b5-16	0		E2-05	kVA Dep.		L4-01	0	
A2-08			b5-17	0		F6-01	3		L4-02	2	
A2-09			b5-18	0		F6-02	0		L4-05	0	
A2-10			b5-19	0		F6-03	1		L4-06	80	
A2-11			b5-20	1		F6-05	0		L5-01	10	
A2-12			b5-21	1		H1-01	70		L5-02	0	
A2-13			b5-22	0		H1-02			L5-03	600	
A2-14			b5-23	0		H1-03	See Table 2 of the bypass schematic		L6-01	6	
A2-15			b5-24	0					L6-02	15	
A2-16			b5-25	0					L6-03	10	
A2-17			b5-26	0		H1-04	4		L8-01	0	
A2-18			b5-27	60		H1-05	6		L8-02	95	
A2-19			b5-28	0		H2-01	0		L8-03	4	
A2-20			b5-29	1		H2-02	3B		L8-06	5	
A2-21			b5-30	0		H3-02	See Table 2 of the bypass schematic		L8-09	1	
A2-22			b8-01	1					L8-10	0	
A2-23			b8-04	kVA Dep.					L8-11	300	
A2-24			b8-05	20		H3-03	0		L8-12	45	
A2-25			b8-06	0		H3-08	See Table 2 of the bypass schematic		L8-15	1	
A2-26			C1-01	60					L8-18	1	
A2-27			C1-02	60					L8-19	20	
A2-28			C1-03	30		H3-09	See Table 2 of the bypass schematic		n1-01	1	
A2-29			C1-04	30					n1-02	1	
A2-30			C1-09	10					n3-01	5	
A2-31			C1-11	0		H3-10	100		n3-02	150	
A2-32			C2-01	0.2		H3-11	0		n3-03	1	
b1-01	See Table 2 of the bypass schematic		C2-02	0.2		H3-12	0.3		n3-04	40	
			C4-01	1		H3-13	See Table 2 of the bypass schematic		o1-01	6	
b1-02	1		C4-02	200					o1-02	1	
b1-03	0		C6-02	kVA Dep.		H4-01	2		o1-03	0	
b1-04	1		C6-03	kVA Dep.		H4-02	100		o1-05	3	
b1-07	1		C6-04	kVA Dep.		H4-03	0		o1-06	0	
b1-08	1		C6-05	0		H4-04	0		o1-07	2	
b1-09	1		d1-01	10.0		H4-04	8		o1-08	3	
b1-11	0		d1-02	6.0		H4-05	50		o2-01	1	
b1-12	0		d1-03	0		H4-06	0		o2-02	0	
b2-01	0.5		d1-04	40		H4-07	0		o2-03	0	
b2-02	50		d1-17	6		H4-08	0		o2-04	kVA Dep.	
b2-03	5.0		d2-01	100		H5-01	1F		o2-05	1	
b2-04	0		d2-02	0		H5-02	3		o2-06	1	
b2-09	0		d2-03	0		H5-03	0		o2-07	0	
b3-01	2		d3-01	0		H5-04	3		o2-08	1	
b3-02	120		d3-02	0		H5-05	1		o2-09	1	
b3-03	2		d3-03	0		H5-06	5		o2-10	0	
b3-05	0.2		d3-04	1		H5-07	1		o2-12	0	
b3-14	1		d4-01	0		H5-08	0		o2-14	0	
b4-01	0		d4-02	10		H5-09	2		o2-15	0	
b4-02	0		E1-01	208, 240V or 480V		L1-01	1		o3-01	0	
b5-01	0					L1-02	8		o3-02	1	
b5-02	2		E1-03	F		L1-03	3		T1-02	kVA Dep.	
b5-03	5		E1-04	60		L1-04	1		T1-04	kVA Dep.	

Warnings and Cautions

This Section provides warnings and cautions pertinent to this product, that if not heeded, may result in personal injury, fatality, or equipment damage. Yaskawa is not responsible for consequences of ignoring these instructions.

WARNING

YASKAWA manufactures component parts that can be used in a wide variety of industrial applications. The selection and application of YASKAWA products remain the responsibility of the equipment designer or end user. YASKAWA accepts no responsibility for the way its products are incorporated into the final system design. Under no circumstances should any YASKAWA product be incorporated into any product or design as the exclusive or sole safety control. Without exception, all controls should be designed to detect faults dynamically and fail safely under all circumstances. All products designed to incorporate a component part manufactured by YASKAWA must be supplied to the end user with appropriate warnings and instructions as to that part's safe use and operation. Any warnings provided by YASKAWA must be promptly provided to the end user. YASKAWA offers an express warranty only as to the quality of its products in conforming to standards and specifications published in the YASKAWA manual. **NO OTHER WARRANTY, EXPRESS OR IMPLIED, IS OFFERED.** YASKAWA assumes no liability for any personal injury, property damage, losses, or claims arising from misapplication of its products.

WARNING

- Read and understand this manual before installing, operating, or servicing this Drive. All warnings, cautions, and instructions must be followed. All activity must be performed by qualified personnel. The Drive must be installed according to this manual and local codes.
- Do not connect or disconnect wiring while the power is on. Do not remove covers or touch circuit boards while the power is on.
- Before servicing, disconnect all power to the equipment. The internal capacitor remains charged even after the power supply is turned off. Status indicator LEDs and Digital Operator display will be extinguished when the DC bus voltage is below 50 VDC. To prevent electric shock, wait at least five minutes after all indicators are OFF and measure DC bus voltage level to confirm safe level.
- Do not perform a withstand voltage test on any part of the unit. This equipment uses sensitive devices and may be damaged by high voltage.
- The Drive and Bypass unit is not suitable for circuits capable of delivering more than the specified RMS symmetrical amperes. Install adequate branch short circuit protection per applicable codes. Refer to the specification. Failure to do so may result in equipment damage and/or personal injury.
- Do not connect unapproved LC or RC interference suppression filters, capacitors, or overvoltage protection devices to the output of the Drive. These devices may generate peak currents that exceed Drive specifications.
- To avoid unnecessary fault displays caused by contactors or output switches placed between Drive and motor, auxiliary contacts must be properly integrated into the control logic circuit.
- YASKAWA is not responsible for any modification of the product made by the user; doing so will void the warranty. This product must not be modified.
- Verify that the rated voltage of the Drive and Bypass unit matches the voltage of the incoming power supply before applying power.
- To meet CE directives, proper line filters and proper installation are required.



- Some drawings in this manual may be shown with protective covers or shields removed, to describe details. These must be replaced before operation.
- Observe electrostatic discharge procedures when handling circuit cards to prevent ESD damage.
- The equipment may start unexpectedly upon application of power. Clear all personnel from the Drive, motor, and machine area before applying power. Secure covers, couplings, shaft keys, and machine loads before energizing the Drive and Bypass unit.
- Please do not connect or operate any equipment with visible damage or missing parts. The operating company is responsible for any injuries or equipment damage resulting from failure to heed the warnings in this manual.

■ Intended Use

Drives and Bypass Units are intended for installation in electrical systems or machinery.

For use in the European Union, the installation in machinery and systems must conform to the following product standards of the Low Voltage Directive:

EN 50178, 1997-10, Equipping of Power Systems with Electronic Devices

EN 60201-1, 1997-12 Machine Safety and Equipping with Electrical Devices

Part 1: General Requirements (IEC 60204-1:1997)/

EN 61010, 1997-11 Safety Requirements for Information Technology Equipment

(IEC 950:1991 + A1:1992 + A2:1993 + A3:1995 + A4:1996, modified)

CE certification per EN 50178 can be achieved using the line filters specified in this manual and following the appropriate installation instructions.

■ Other

The Drive and Bypass unit is suitable for use on a circuit capable of delivering not more than 100,000 RMS symmetrical amperes, 240Vac maximum (240V Class) and 480Vac maximum (480V Class).

This manual is for reference only and subject to change without notice.

Introduction

This Section describes the applicability of the Manual

◆ Product Description

The P7 Bypass unit provides a means of bypassing the Drive while allowing the motor to operate at full speed, directly from the AC line. It incorporates an AC Drive and three contactor Bypass arrangement in a single UL listed enclosure. The three electrically interlocked IEC rated contactors isolate the Drive when operating in Bypass mode.

Control logic provides industry standard Hand/Off/Auto functions and safety circuit interlocks in both drive and Bypass operating modes.

Bypass components include: a fused 120 VAC control circuit transformer, an input Motor Circuit Protector (MCP) circuit breaker/disconnect, motor overload relay, selector switches and indicating lights.

The P7 Drive, a component of the P7 Bypass package, is a Pulse Width Modulated Drive for 3-Phase AC induction motors. This type of Drive is also known as an Adjustable Frequency Drive, Variable Frequency Drive, AC Drive, AFD, ASD, VFD, and Inverter. In this manual, the P7 Drive will be referred to as the “Drive”.

The Drive is a variable torque AC drive, designed specifically for HVAC applications, including fans, blowers and pumps. A new benchmark for size, cost, performance, benefits, and quality, the Drive includes numerous built-in features such as network communications, H/O/A, PI, parameter storage and copy functions.

The Drive has communications for the popular protocols: DeviceNet, Profibus, Ethernet, etc. An optional LONWORKS® interface card is also available.

The LCD keypad/operator is equipped with Hand/Off/Auto functions, copy feature, 7 language choices, and 5 lines of display with 16 characters per line. User parameter settings can be recovered at any time via “User Initialization”. Optional DriveWizard software allows upload/download, as well as graphing and monitoring of drive parameters from a PC for ease of drive management.

Built-in PI eliminates the need for closed loop output signals from a building automation system. It includes feedback display, inverse, square root and differential control functions, and maintains setpoint for closed loop control of fans and pumps for pressure, flow, or temperature regulation.

This manual is applicable to P7 Drives defined by model numbers of CIMR-P7U_ _ _ _ contained within Bypass units defined by model numbers of P7B_ _ _ _.

This manual is subject to change as product improvements occur. The latest version of the manual can be obtained from the Yaskawa website www.drives.com. The date shown on the rear cover is changed when revisions are made. The latest version of Drive software is also shown.

This manual may describe trademarked equipment, which is the property of other companies. These trademarks are the property of the registered owner companies and may include the following:

PROFIBUS® and PROFIBUS-DP® are registered trademarks of PROFIBUS Nutzerorganization e.v.

DeviceNet is a registered trademark of ODVA (Open DeviceNet Vendor Association, Inc.)

Modbus®, trademark of Schneider Automation, Inc.

LONWORKS®, trademark of Echelon Corporation

Other Documents and Manuals are available to support special use or installation of this product. These documents may be provided with the product or upon request or downloaded from www.drives.com. Documents may include the following:

TM.P7.02.Programming ... Manual included on CD ROM with product

DriveWizard ... Software and Manual...Included on CD ROM with product

Option Instructions ... Included on CD ROM with product

◆ Definitions of Acronyms and Abbreviations

AC	Alternating Current	LRA	Locked Rotor Amperes
AIC	Amps Interrupting Capacity	MCP	Motor Circuit Protector
CB	Circuit Breaker	MTBF	Mean Time Between Failures
CIMR	Control Induction Motor Rotation	NC	Normally Closed
CN	Connector	NEC	National Electrical Code
CPT	Control Power Transformer	NEMA	National Electrical Manufacturers Association
CPU	Central Processing Unit	NO	Normally Open
DIP	Dual Inline Package	OLR	Over Load Relay
FLA	Full Load Amperes	PCB	Printed Circuit Board
FVFF	Forced Ventilated, inlet Filter, outlet Filter	PI	Proportional plus Integral control action
HOA	Hand/Off/Auto	SFS	Soft Start
HP	Horsepower	TB	Terminal Block
IEC	International Electrotechnical Commission	THD	Total Harmonic Distortion
IGV	Inlet Guide Vanes	VA	Volt Amperes
IPM	Intelligent Power Module	VAC	Volts Alternating Current
KVA	Kilo Volt Amperes	VAV	Variable Air Volume
LED	Light Emitting Diode		

◆ Terminology in This Manual

“Standard” or “Configured” options - are available with standard lead times

“Engineered” or “Custom” options - are available only with extended lead times

◆ Resources Available

Table of Resources	
Manuals, Installation Guides, and CD's	
Document Number	Description
TM.P7.01	Drive User Manual
TM.P7.02	Drive Programming Manual
TM.AFD.14	DeviceNet Technical Manual
TM.AFD.12	Profibus Technical Manual
IG.AFD.20	LONWORKS® Option Installation Guide
IG.AFD.50	3-15 PSI Pressure Transducer Installation Guide
CD.AFD7.01	CD ROM for Drives
Software	
Document	Description
DriveWizard® Software	DriveWizard® Software Version 5.3 or later

Notes:

Table of Contents

Quick Reference Parameter List	Inside front cover
Warnings and Cautions	i
Introduction.....	iii
Chapter 1 - Physical Installation	1-1
Bypass Model Number and Enclosure Style	2
Enclosure Data	4
Confirmations upon Delivery	7
Bypass Product Options	9
Bypass Component Descriptions	11
Exterior and Mounting Dimensions	17
Checking and Controlling Installation Site	24
Chapter 2 - Electrical Installation	2-1
Termination Configuration - Power Wiring	2
Control Wiring	9
Wiring Diagram	20
Logic Diagram	22
Chapter 3 - Digital Operator.....	3-1
Digital Operator and Control Panel Display	2
Drive Main Menus	8
Example of Changing a Parameter	16
Chapter 4 - Start Up and Operation	4-1
Start Up Introduction	2
Bypass Start Up Preparation.....	3
Bypass Unit Start Up Procedure	4
Bypass Operation Description.....	8
Chapter 5 - Programming	5-1
Bypass Basic Programming Parameters	2

Chapter 6 - Diagnostics & Troubleshooting	6-1
Bypass Diagnostics	2
Drive Diagnostics	3
Drive Troubleshooting	16
Drive Main Circuit Test Procedure	22
Drive Date Stamp Information	26
 Chapter 7 - Maintenance	 7-1
Maintenance	2
Removing and Replacing Drive in a Bypass Unit	9
 Appendix A - Parameters	 A-1
Parameter List	2
Monitor List	26
Fault Trace List	28
Fault History List	29
 Appendix B - Capacity Related Parameters	 B-1
Drive Capacity	2
 Appendix C - Specifications	 C-1
Standard Drive and Bypass Specifications	2
 Appendix D - Communication	 D-1
Using Modbus Communication	2
Modbus Function Code Details	7
Modbus Data Tables	9
Modbus Self-Diagnosis	14
 Appendix E - Peripheral Devices	 E-1
General Peripheral Devices	2

Appendix F - Replacement Parts F-1

Primary Parts - 208/230/240VAC 2
Primary Parts - 480VAC 3
Bypass Replacement Parts..... 4

Notes:

Chapter 1

Physical Installation

This chapter describes the checks required upon receiving and the installation process for a Drive and Bypass unit.

Bypass Model Number and Enclosure Style	2
Enclosure Data	4
Confirmations upon Delivery	7
Receiving Checks	7
Bypass Nameplate Information	7
Bypass Unit Enclosures	8
Bypass Product Options	9
Bypass Component Descriptions	11
Bypass Unit Front Control Panel	11
Exterior and Mounting Dimensions	17
Bypass Unit 30 HP and Below, 480 VAC; 15 HP and Below, 208V/240V	17
Bypass Unit 30 HP and Below, 480 VAC; 15 HP and Below, 208V/240V With Add-On Box	18
Bypass Unit 40 HP to 100 HP, 480 VAC; 20 HP to 40 HP, 208V/240V	19
Bypass Unit 40 HP to 100 HP, 480 VAC; 20 HP to 40 HP, 208V/240V With Add-On Box	20
Bypass Unit 125 HP to 250 HP, 480 VAC; 50 HP to 125 HP, 208V	21
Dimensions and Weights	22
Checking and Controlling Installation Site	24
Installation Site	24
Controlling the Ambient Temperature	25
Protecting the Bypass Unit from Foreign Matter	25
Installation Orientation and Enclosure Considerations	26

Bypass Model Number and Enclosure Style

The Bypass covers two voltage ranges: 208-240 VAC and 480 VAC. Ratings applicable are from 1/2 to 500 HP.

Table 1.1 Bypass					
Voltage	Bypass Base Model Number		HP	Bypass Continuous Output Current (Amps)	Uses Basic Drive Model Number
	NEMA 1	*NEMA 12 FVFF			
208 VAC	P7BVD002	P7BBD002	0.5	2.4	CIMR-P7U22P2
	P7BVD003	P7BBD003	0.75	3.5	CIMR-P7U22P2
	P7BVD004	P7BBD004	1	4.6	CIMR-P7U22P2
	P7BVD007	P7BBD007	2	7.5	CIMR-P7U22P2
	P7BVD010	P7BBD010	3	10.6	CIMR-P7U22P2
	P7BVD016	P7BBD016	5	16.7	CIMR-P7U23P7
	P7BVD024	P7BBD024	7.5	24.2	CIMR-P7U27P5
	P7BVD030	P7BBD030	10	30.8	CIMR-P7U27P5
	P7BVD046	P7BBD046	15	46.2	CIMR-P7U2011
	P7BVD059	P7BBD059	20	59.4	CIMR-P7U2015
	P7BVD074	P7BBD074	25	74.8	CIMR-P7U2018
	P7BVD088	P7BBD088	30	88	CIMR-P7U2022
	P7BVD114	P7BBD114	40	114	CIMR-P7U2030
	P7BVD143	P7BBD143	50	143	CIMR-P7U2037
	P7BVD169	P7BBD169	60	169	CIMR-P7U2045
	P7BVD211	P7BBD211	75	211	CIMR-P7U2055
	P7BVD273	P7BBD273	100	273	CIMR-P7U2075
	P7BVD343	P7BBD343	125	343	CIMR-P7U2090
P7BVD396	P7BBD396	150	396	CIMR-P7U2110	
240 VAC	P7BVA002	P7BBA002	0.5	2.2	CIMR-P7U22P2
	P7BVA003	P7BBA003	0.75	3.2	CIMR-P7U22P2
	P7BVA004	P7BBA004	1	4.0	CIMR-P7U22P2
	P7BVA006	P7BBA006	2	6.8	CIMR-P7U22P2
	P7BVA009	P7BBA009	3	9.6	CIMR-P7U22P2
	P7BVA015	P7BBA015	5	15.2	CIMR-P7U23P7
	P7BVA022	P7BBA022	7.5	22	CIMR-P7U25P5
	P7BVA028	P7BBA028	10	28	CIMR-P7U27P5
	P7BVA042	P7BBA042	15	42	CIMR-P7U2011
	P7BVA054	P7BBA054	20	54	CIMR-P7U2015
	P7BVA068	P7BBA068	25	68	CIMR-P7U2018
	P7BVA080	P7BBA080	30	80	CIMR-P7U2022
P7BVA104	P7BBA104	40	104	CIMR-P7U2030	

Table 1.1 Bypass (Continued)					
Voltage	Bypass Base Model Number		HP	Bypass Continuous Output Current (Amps)	Uses Basic Drive Model Number
	NEMA 1	*NEMA 12 FVFF			
230 VAC	P7BVA130	P7BBA130	50	130	CIMR-P7U2037
	P7BVA154	P7BBA154	50	154	CIMR-P7U2037
	P7BVA192	P7BBA192	60	192	CIMR-P7U2045
	P7BVA248	P7BBA248	75/100	248	CIMR-P7U2075
	P7BVA312	P7BBA312	125	312	CIMR-P7U2075
	P7BVA360	P7BBA360	150	360	CIMR-P7U2090
480 VAC	P7BVB001	P7BBB001	0.5	1.1	CIMR-P7U42P2
	P7BVB001	P7BBB001	0.75	1.6	CIMR-P7U42P2
	P7BVB002	P7BBB002	1	2.1	CIMR-P7U42P2
	P7BVB003	P7BBB003	2	3.4	CIMR-P7U42P2
	P7BVB004	P7BBB004	3	4.8	CIMR-P7U42P2
	P7BVB007	P7BBB007	5	7.6	CIMR-P7U43P7
	P7BVB011	P7BBB011	7.5	11	CIMR-P7U45P5
	P7BVB014	P7BBB014	10	14	CIMR-P7U47P5
	P7BVB021	P7BBB021	15	21	CIMR-P7U4011
	P7BVB027	P7BBB027	20	27	CIMR-P7U4011
	P7BVB034	P7BBB034	25	34	CIMR-P7U4015
	P7BVB040	P7BBB040	30	40	CIMR-P7U4018
	P7BVB052	P7BBB052	40	52	CIMR-P7U4030
	P7BVB065	P7BBB065	50	65	CIMR-P7U4030
	P7BVB077	P7BBB077	60	77	CIMR-P7U4037
	P7BVB096	P7BBB096	75	96	CIMR-P7U4045
	P7BVB124	P7BBB124	100	124	CIMR-P7U4055
	P7BVB156	P7BBB156	125	156	CIMR-P7U4075
P7BVB180	P7BBB180	150	180	CIMR-P7U4090	
P7BVB240	P7BBB240	200	240	CIMR-P7U4110	
P7BVB302	P7BBB302	250	302	CIMR-P7U4160	

* The Nema 12 FVFF Enclosure is ventilated and filtered with gaskets. UL does not recognize NEMA 12 ventilated enclosures, therefore, for UL purposes, these units are designated NEMA 1.

Enclosure Data

Table 1.2 208V Enclosure Data

Input Volts	HP ¹	Drive Model CIMR-	Bypass ² Model Number	NEC FLA	OL 110% 1 min	Heat ³ Loss Watts	Enclosure Dimensions ⁴ NEMA 1 & NEMA 12 -FVFF H W D inches			Weight ⁵ of Assembly	Enclosure Dimensions w/Add-on ⁴ NEMA 1 & NEMA 12-FVFF H W D inches			Weight ⁵ of Assembly +Add-on Box	Electrical Schematic
							H	W	D		H	W	D		
208	0.5	P7U22P21A	P7B_D002	2.4	2.6	68	29.48	19.06	13.66	115 lbs	43.35	19.06	13.66	156 lbs	P7B-00
	0.75	P7U22P21A	P7B_D003	3.5	3.8	68									
	1	P7U22P21A	P7B_D004	4.6	5.1	78									
	2	P7U22P21A	P7B_D007	7.5	8.2	110									
	3	P7U22P21A	P7B_D010	10.6	11.7	141									
	5	P7U23P71A	P7B_D016	16.7	18.4	202									
	7.5	P7U27P51A	P7B_D024	24.2	26.6	273									
	10	P7U27P51A	P7B_D030	30.8	33.9	365	127 lbs	164 lbs							
	15	P7U20111A	P7B_D046	46.2	50.8	578									
	20	P7U20151A	P7B_D059	59.4	65.3	653	40.48	25.63	14.66	208 lbs	55.35	25.63	14.66	291 lbs	
	25	P7U20181A	P7B_D074	74.8	82.3	746									
	30	P7U20221A	P7B_D088	88.0	96.8	939									
	40	P7U20301A	P7B_D114	114.0	125.4	1340	40.48	25.63	14.66	221 lbs	55.35	25.63	14.66	307 lbs	
	50	P7U20370A	P7B_D143	143.0	157.3	1523									
	60	P7U20450A	P7B_D169	169.0	185.9	1762									
75	P7U20550A	P7B_D211	211.0	232.1	2244										
100	P7U20750A	P7B_D273	273.0	300.3	3003										
125	P7U20900A	P7B_D343	343.0	377.3	3296										
150	P7U21100A	P7B_D396	396.0	435.6	4029	84.00	25.63	26.25 ⁸	847 lbs	943 lbs	1214 lbs	1330 lbs	1423 lbs	NOT REQUIRED	
Dimension Drawing ⁶ S-5542	Dimension Drawing S-5543														
Dimension Drawing ⁷ S-5544	Dimension Drawing S-5545														
Dimension Drawing ⁹ S-5550															

Note 1: Horsepower rating is based on a standard NEMA B 4-pole motor.

Note 2: The underscore position in these model numbers codes for the enclosure type: V = NEMA1, B = NEMA12 FVFF.

Note 3: Heat loss is the amount of heat dissipated by the drive at full load with all standard options available inside the enclosure. Drive heat sink losses are included in the heat loss data. Heat loss data is for the enclosure without the add-on enclosure.

Note 4: Height dimension (H) excludes the mounting screw tabs. Depth dimension (D) excludes MCP disconnect handle.

Note 5: This data represents the total weight with all possible standard options. Weight could be less depending on the options specified.

Note 6: All standard options are available in this size enclosure except options E (RFI Filter) and K (5% Output Reactor). Options E and K require the add-on enclosure.

Note 7: All options are available in this size enclosure except E (RFI Filter), R (3% Line Reactor), and K (5% Output Reactor). Only option E combined with either option R or option K can be installed in the add-on enclosure. Options R and K together require an increase in the size of the P7 Bypass Enclosure. Contact the factory if all three options are required. Options D (2 Motor "OR") or A (2 Motor "AND") for 30 Hp and 40 Hp require the next size enclosure.

Note 8: Heat sink mounted externally varies the depth dimension depending on the drive size. Depth will not exceed dimension shown.

Note 9: All options are available in this size enclosure except options D (2 Motor "OR") or A (2 Motor "AND") for 75 Hp and 100 Hp require the next size enclosure.

Table 1.3 240/230V Enclosure Data

Input Volts	HP ¹	Drive Model CIMR-	Bypass ² Model Number	NEC FLA	OL 110% 1 min	Heat ³ Loss Watts	Enclosure Dimensions ⁴ NEMA 1 & NEMA 12 -FVFF H W D inches			Weight ⁵ of Assembly	Enclosure Dimensions w/Add-on ⁴ NEMA 1 & NEMA 12-FVFF H W D inches			Weight ⁵ of Assembly +Add-on Box	Electrical Schematic				
							H	W	D		H	W	D						
240	0.5	P7U22P21A	P7B_A002	2.2	2.4	68	29.48	19.06	13.66	115 lbs	43.35	19.06	13.66	156 lbs	P7B-00				
	0.75	P7U22P21A	P7B_A003	3.2	3.5	68													
	1	P7U22P21A	P7B_A004	4.0	4.4	78													
	2	P7U22P21A	P7B_A006	6.8	7.5	110													
	3	P7U22P21A	P7B_A009	9.6	10.6	141													
	5	P7U23P71A	P7B_A015	15.2	16.7	202													
	7.5	P7U25P51A	P7B_A022	22.0	24.2	273	Dimension Drawing ⁶ S-5542			Dimension Drawing S-5543									
	10	P7U27P51A	P7B_A028	28.0	30.8	365				127 lbs				164 lbs					
	15	P7U20111A	P7B_A042	42.0	46.2	578													
	20	P7U20151A	P7B_A054	54.0	59.4	653	40.48	25.63	14.66	208 lbs	55.35	25.63	14.66	291 lbs					
	25	P7U20181A	P7B_A068	68.0	74.8	746				Dimension Drawing ⁷ S-5544				Dimension Drawing S-5545					
	30	P7U20221A	P7B_A080	80.0	88.0	939								221 lbs					307 lbs
40	P7U20301A	P7B_A104	104.0	114.4	1340														
230	50	P7U20370A	P7B_A130	130.0	143.0	1523	84.00	25.63	26.25 ⁸	847 lbs	NOT REQUIRED								
	60	P7U20370A	P7B_A154	154.0	169.4	1544				943 lbs									
	75	P7U20450A	P7B_A192	192.0	211.2	1860				Dimension Drawing ⁹ S-5550					1214 lbs				
	100	P7U20750A	P7B_A248	248.0	272.8	3003									1330 lbs				
	125	P7U20750A	P7B_A312	312.0	343.2	3045									1423 lbs				
	150	P7U20900A	P7B_A360	360.0	396.0	3440													

Note 1: Horsepower rating is based on a standard NEMA B 4-pole motor.

Note 2: The underscore position in these model numbers codes for the enclosure type: V = NEMA1, B = NEMA12 FVFF.

Note 3: Heat loss is the amount of heat dissipated by the drive at full load with all standard options available inside the enclosure. Drive heat sink losses are included in the heat loss data. Heat loss data is for the enclosure without the add-on enclosure.

Note 4: Height dimension (H) excludes the mounting screw tabs. Depth dimension (D) excludes MCP disconnect handle.

Note 5: This data represents the total weight with all possible standard options. Weight could be less depending on the options specified.

Note 6: All standard options are available in this size enclosure except options E (RFI Filter) and K (5% Output Reactor). Options E and K require the add-on enclosure.

Note 7: All options are available in this size enclosure except E (RFI Filter), R (3% Line Reactor), and K (5% Output Reactor). Only option E combined with either option R or option K can be installed in the add-on enclosure. Options R and K together require an increase in the size of the P7 Bypass Enclosure. Contact the factory if all three options are required. Options D (2 Motor "OR") or A (2 Motor "AND") for 30 Hp and 40 Hp require the next size enclosure.

Note 8: Heat sink mounted externally varies the depth dimension depending on the drive size. Depth will not exceed dimension shown.

Note 9: All options are available in this size enclosure except options D (2 Motor "OR") or A (2 Motor "AND") for 75 Hp and 100 Hp require the next size enclosure.

Table 1.4 480V Enclosure Data

Input Volts	HP ¹	Drive Model CIMR-	Bypass ² Model Number	NEC FLA	OL 110% 1 min	Heat ³ Loss Watts	Enclosure Dimensions ⁴ NEMA 1 & NEMA 12 -FVFF			Weight ⁵ of Assembly	Enclosure Dimensions w/Add-on ⁴ NEMA 1 & NEMA 12-FVFF			Weight ⁵ of Assembly +Add-on Box	Electrical Schematic
							H inches	W inches	D inches		H inches	W inches	D inches		
480	0.5	P7U42P21A	P7B_B001	1.1	1.2	57	29.48	19.06	13.66	115 lbs	43.35	19.06	13.66	156 lbs	P7B-00
	0.75	P7U42P21A	P7B_B001	1.6	1.8	57									
	1	P7U42P21A	P7B_B002	2.1	2.3	62									
	2	P7U42P21A	P7B_B003	3.4	3.7	89									
	3	P7U42P21A	P7B_B004	4.8	5.3	121									
	5	P7U43P71A	P7B_B007	7.6	8.4	155									
	7.5	P7U45P51A	P7B_B011	11.0	12.1	217									
	10	P7U47P51A	P7B_B014	14.0	15.4	318									
	15	P7U40111A	P7B_B021	21.0	23.1	404									
	20	P7U40111A	P7B_B027	27.0	29.7	408									
	25	P7U40151A	P7B_B034	34.0	37.4	485									
	30	P7U40181A	P7B_B040	40.0	44.0	618									
	40	P7U40301A	P7B_B052	52.0	57.2	1040	40.48	25.63	14.66	203 lbs	55.35	25.63	14.66	281 lbs	
	50	P7U40301A	P7B_B065	65.0	71.5	1045				232 lbs				319 lbs	
	60	P7U40371A	P7B_B077	77.0	84.7	1197				241 lbs				332 lbs	
	75	P7U40451A	P7B_B096	96.0	105.6	1357	84.00	25.63	26.25 ⁸	943 lbs	NOT REQUIRED	NOT REQUIRED	NOT REQUIRED		
	100	P7U40551A	P7B_B124	124.0	136.4	1749				1240 lbs					
	125	P7U40750A	P7B_B156	156.0	171.6	2032								1352 lbs	
	150	P7U40900A	P7B_B180	180.0	198.0	2486	Dimension Drawing ⁹ S-5550	240 lbs	1352 lbs						
	200	P7U41100A	P7B_B240	240.0	264.0	2955									
250	P7U41600A	P7B_B302	302.0	332.2	4225	TBD	TBD	TBD							
300	P7U41850A	P7B_B361	361.0	397.1	4425										
350	P7U41850A	P7B_B414	414.0	455.4	4451										
400	P7U42200A	P7B_B477	477.0	524.7	5099										
450	P7U42200A	P7B_B515	515.0	566.5	5154										
500	P7U43000A	P7B_B590	590.0	649.0	7329										

Note 1: Horsepower rating is based on a standard NEMA B 4-pole motor.

Note 2: The underscore position in these model numbers codes for the enclosure type: V = NEMA1, B = NEMA12 FVFF.

Note 3: Heat loss is the amount of heat dissipated by the drive at full load with all standard options available inside the enclosure. Drive heat sink losses are included in the heat loss data. Heat loss data is for the enclosure without the add-on enclosure.

Note 4: Height dimension (H) excludes the mounting screw tabs. Depth dimension (D) excludes MCP disconnect handle.

Note 5: This data represents the total weight with all possible standard options. Weight could be less depending on the options specified.

Note 6: All standard options are available in this size enclosure except options E (RFI Filter) and K (5% Output Reactor). Options E and K require the add-on enclosure.

Note 7: All options are available in this size enclosure except E (RFI Filter), R (3% Line Reactor), and K (5% Output Reactor). Only option E combined with either option R or option K can be installed in the add-on enclosure. Options R and K together require an increase in the size of the P7 Bypass Enclosure. Contact the factory if all three options are required. Options D (2 Motor "OR") or A (2 Motor "AND") for 75 Hp and 100 Hp require the next size enclosure.

Note 8: Heat sink mounted externally varies the depth dimension depending on the drive size. Depth will not exceed dimension shown.

Note 9: All options are available in this size enclosure except options D (2 Motor "OR") or A (2 Motor "AND") for 200 Hp and 250 Hp require the next size enclosure.

Confirmations upon Delivery

◆ Receiving Checks

Check the following items as soon as the Drive and Bypass unit is delivered.

Item	Method
Has the correct model of Bypass unit been delivered?	Check the model number on the nameplate on the right side of the Bypass unit. Reconcile with packing slip and/or order information.
Is the Bypass unit damaged in any way?	Inspect the entire exterior of the Bypass unit to see if there are any dents, scratches or other damage resulting from shipping.
Are any screws or other components loose?	Use a screwdriver or the appropriate tool to check for tightness.

If you find any irregularities in the above items, contact the shipping company, the distributor or representative you purchased the Bypass unit from or your Yaskawa office immediately.

The Bypass unit is thoroughly tested at the factory. Any damages or shortages evident when the equipment is received must be reported immediately to the commercial carrier that transported the material. Shipping damage is not covered by the Yaskawa warranty. After unpacking and inspecting for damage, verify that internal wire connections have not come loose during shipment by spot checking wire terminations with a screwdriver or the appropriate tool.

Bypass unit storage must be in a clean and dry location. Maintain the factory packaging and provide covering as needed to protect the Bypass unit from construction site dirt, water, debris and traffic prior to and during construction.

◆ Bypass Nameplate Information

A nameplate is attached to the right side of the enclosure and the inside of the door of each Bypass unit.

The nameplate shown below is an example for a standard Bypass unit.

A.C. INPUT	
Volts: 480	Hz: 50/60
Phase: 3	Amps: 71.6
A.C. OUTPUT	
Volts: 0-480	Hz: 0-60
Phase: 3	Amps: 65
Serial No: 4W033727440-0002	
Model No: P7BVB065R	
Type: P7 BYPASS	
W.D.: P7B-00	
Inst. Manual: TM.P7B.01,CD.AFD7.01	
 YASKAWA	
UNPN0001	

Fig 1.1 Bypass Nameplate
(Example)

Bypass Product Options

Option A - Two motor “AND” control: Allows the operation of two motors from one Drive or Bypass. Pump #1 “AND” pump #2 are operated at the same speed via the output from one Drive or Bypass. The motors are always operated simultaneously therefore, no transfer switch is involved. With the 2 motor “AND” option, motor OverLoad Relays and fuses are provided for each motor and the Drive’s internal motor overload function is disabled.

The two motors can be of different capacity if this capacity difference was considered in the ordering process. The factory needs to know the FLA value of each motor controlled in order to select the correct motor overload devices and fuses. (Specifying different capacity motors results in longer, non-standard lead times).

Option D - Two motor “OR” control: A MTR #1/AUTO/MTR #2 selector switch is provided to allow local or remote motor operation selection, between two identical motors, for control by either the Drive or the Bypass (for example, Pump #1 “OR” AUTO “OR” Pump #2). In the **AUTO** position, a customer supplied contact closure at TB1 terminals 23 and 24 can switch between the two motors. The two motors must be the same horsepower and current draw.

Option E - RFI/EMI Filter: Filters to further attenuate possible VFD generated noise. Radio frequency interference/electro magnetic interference filters reduce conducted noise on the Drive input power leads and therefore, radiated noise from those leads. This option is installed on the input power side of the Drive, between the input contactor and the Drive.

Option F - Drive Input Fuses: Fuses capable of protecting semiconductor devices, rated at 200 kAIC are connected to the line side of the Drive, between the input contactor and the Drive, to protect the Drive semiconductors when motor or output conductor short circuit faults occur.

Option G - Serial Communication, DeviceNet: An option card that provides DeviceNet protocol for network communication.

Option H - Serial Communication, Profibus: An option card that provides Profibus protocol for network communication.

Option K - 5% Output Reactor: Employed on the output side of the Drive for reduction of peak voltages applied to the driven motor. In long Drive to motor lead length situations, high carrier frequency and reflected waves can cause high voltage spikes at the motor. An output reactor provides motor protection in these long motor lead length situations. This option is installed on the output power side of the Drive, between the output contactor and the Drive.

Option L - Serial Communication, Echelon LonWorks: An isolated RS-422/485 circuit board provides LonTalk protocol for network communication. This option plugs into the CN2 connection on the Drive control circuit board.

Option M - 4 to 20 mA Output: Provides two programmable 0 to 10 VDC analog outputs or two programmable 4 to 20 mA analog outputs.

Option N - Input Capacitive Network Radio Frequency Interference Filter: Electronic equipment can be sensitive to low levels of voltage distortion and electrical noise. This passive wye-delta capacitive filter is intended for installation on the VFD input in order to protect other sensitive electronic loads, it provides attenuation of conducted RFI and EMI.

Option P - Pressure to Electrical Transducer: This transducer is employed when converting a pneumatic signal to an electrical signal for use as the Drive speed command input. The need for this option comes up on retrofit applications when the pneumatic signal that formerly controlled the pneumatic actuator on Inlet Guide Vanes (IGV), for example, is now to be used to control the fan speed via the Drive. This option is wired to Drive terminals +V, A2 and AC, parameters H3-10 and H3-11 are used for final field calibration of this input if there is jobsite variation from the typical 3 to 15 PSIG pneumatic signal input range.

Option Q - Serial Communication, Ethernet: An option card that provides Modbus TCP protocol for network communication.

Option R - 3% Input Line Reactor: Employed on the input side of the Drive for Total Harmonic Distortion (THD) suppression. A line reactor also minimizes the potential for Drive input diode damage from line transients and reduces voltage peaks on the DC bus capacitors. This option is installed on the input power side of the Drive, between the input contactor and the Drive.

Option S - Speed Potentiometer: A door mounted single turn potentiometer for manual control of Drive output and motor speed. This option is wired to Drive terminals +V, A1 and AC and is used as the local speed command input to the Drive instead of the keypad up and down arrows. Parameters for use of this option in conjunction with other input signals are detailed in Table 5.2.

Option V - Embedded Serial Communication, Modbus: A no cost option. The Drive in a Bypass unit is capable of Modbus network communication via the standard RS-422/485 terminals.

Option W - Engraved Plastic Nameplate: An enclosure identification nameplate to carry the controlled equipment “tag number”.

Option X - 3% DC Bus Reactor: Attenuates harmonic distortion by limiting the rate of rise of the input current. The bus reactor is wired to the Drive (+1) and (+2) DC bus terminals to provide the equivalent impedance of a 3% input reactor. This option is only used on the low end of the horsepower range where DC bus reactors are not a standard Drive component (25 HP and below @ 208 VAC, 25 HP and below @ 240 VAC, and 30 HP and below @ 480 VAC.)

Option Z - 5% DC Bus Reactor: Attenuates harmonic distortion by limiting the rate of rise of the input current. The bus reactor is wired to the Drive (+) and (-) DC bus terminals to provide the equivalent impedance of a 5% input reactor. This option is only used on the low end of the horsepower range where DC bus reactors are not a standard Drive component (25 HP and below @ 208 VAC, 25 HP and below @ 240 VAC, and 30 HP and below @ 480 VAC.)

Bypass Component Descriptions

◆ Bypass Unit Front Control Panel

The external appearance, component names, and terminal arrangement of the Bypass unit is shown in Figures 1.4 through 1.8.

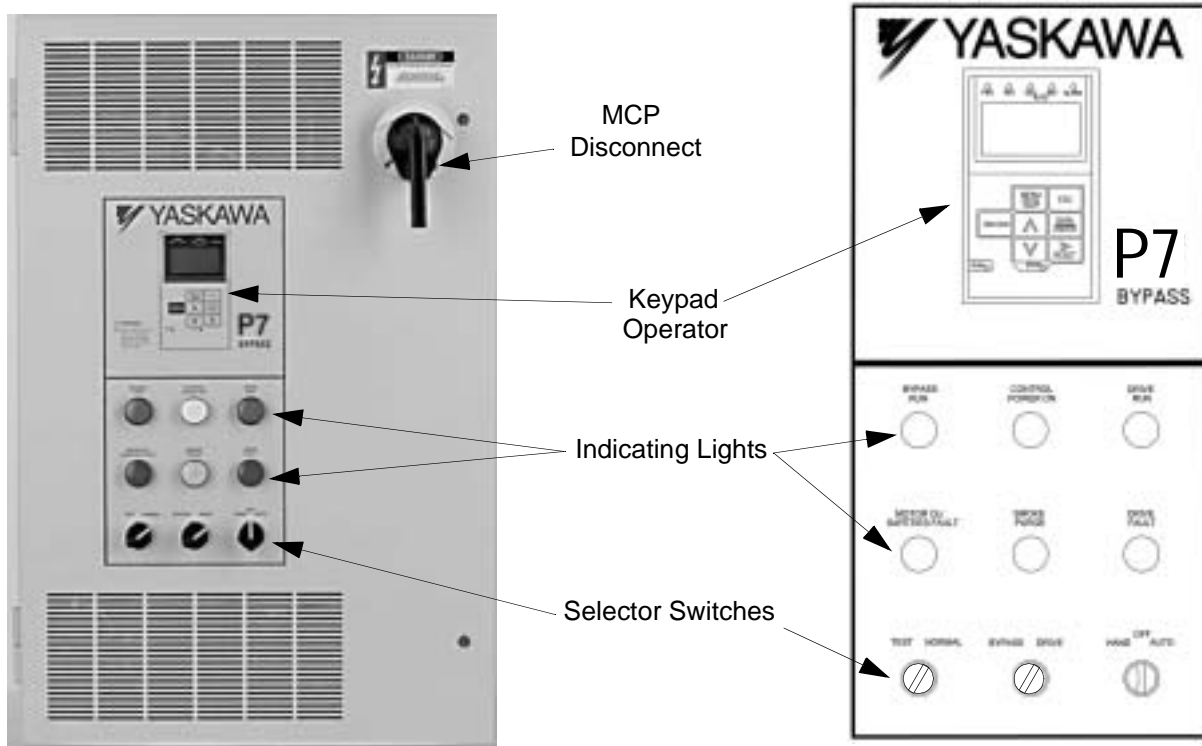

Fig 1.4 E7 Bypass Unit Appearance

■ Keypad Operator

In a Bypass unit the keypad operator is mounted flush with the hinged door of the enclosure. The addition of a **HAND/OFF/AUTO** selector switch for the Bypass logic circuit makes the Hand, Off and Auto keys on the standard Drive keypad operator redundant. In this Bypass configuration the keypad Hand, Off and Auto keys are disabled in the Drive firmware and a mask (membrane) is placed over the keypad operator to cover these keys, avoiding the potential for confusion. The membrane over the Drive keypad is non-removable on these Bypass units (In order to use the keypad copy function on a Bypass unit - order a separate keypad).

■ Indicating Lights

On the enclosure door just below the digital operator are six 22 mm, 24 VAC LED indicating lights for: “Control Power”, “Drive Run”, “Bypass Run”, “Motor OL/Safeties Fault”, “Drive Fault” and “Smoke Purge”. LED type indicating lights are provided to improve the reliability well beyond that of incandescent bulbs. LED’s have a MTBF of 100K hours, eliminating any need for “push to test” type pilot lights.

■ HAND/OFF/AUTO Selector Switch

A three position rotary switch employed to control the source of the motor start and speed commands in either the Drive or Bypass operating modes.

Hand Position – Drive Mode: The Drive input and output contactors are energized and the Drive is given a run command. Operation is via the local speed input from the keypad or optional speed potentiometer.

Hand Position – Bypass Mode: The Bypass contactor is energized causing the motor to run at full speed directly across-the-line.

Off Position: No power is applied to the Bypass circuit. The Drive input and output contactors are energized and the Drive is stopped (run command removed). The Off position takes precedence over a serial communication run command.

Auto Position – Drive Mode: The Drive input and output contactors are energized. The Drive is enabled to receive a run command contact closure and speed input analog signal from a separate source.

Auto Position – Bypass Mode: The motor full speed across-the-line run/stop is controlled by a customer supplied contact closure, energizing the Bypass contactor.

The H/O/A switch must be in the **AUTO** position if serial communication is to be used for Drive run, stop and speed control.

■ DRIVE/BYPASS Selector Switch

A two position rotary switch selecting motor operation from the Drive or directly across-the-line. When transferring from Drive operation to Bypass operation, the logic circuit will require the Bypass unit to stop the motor before completing the transfer to full speed across-the-line operation.

■ NORMAL/TEST Selector Switch

A two position rotary switch, test position is used to energize the Drive input contactor while operating in the Bypass mode (via the **HAND** or **AUTO** switch position). In Drive mode switching from **NORMAL** to **TEST** position will remove the power from the Drive and the motor will stop. In Bypass mode the test position powers the Drive for programming or other “tests” while keeping it isolated from the motor.

■ MCP Motor Circuit Protector Circuit Breaker/Disconnect

Electrically located on the input power side of the Bypass unit, the MCP adjustable, instantaneous trip circuit breaker provides protection from short circuits for the motor power cables. The Bypass three phase input power connection is made to the input terminals of the MCP. The door mounted rotary operating mechanism is a convenient means of disconnecting the Bypass unit from line power for equipment maintenance. The MCP must be in the OFF position in order to open the enclosure door. Service and troubleshooting personnel are provided with a means to defeat this door interlock. The rotary handle provides trip indication and can be padlocked in the OFF position.



CAUTION
Only qualified service personnel should use the defeator feature.

Fig 1.5 MCP Handle Positions – RESET/LOCK, OFF, TRIP, ON Shown in the “ON” position



Fig 1.6 MCP Handle Positions – Shown OFF, With Padlock

■ Internal Bypass Panel

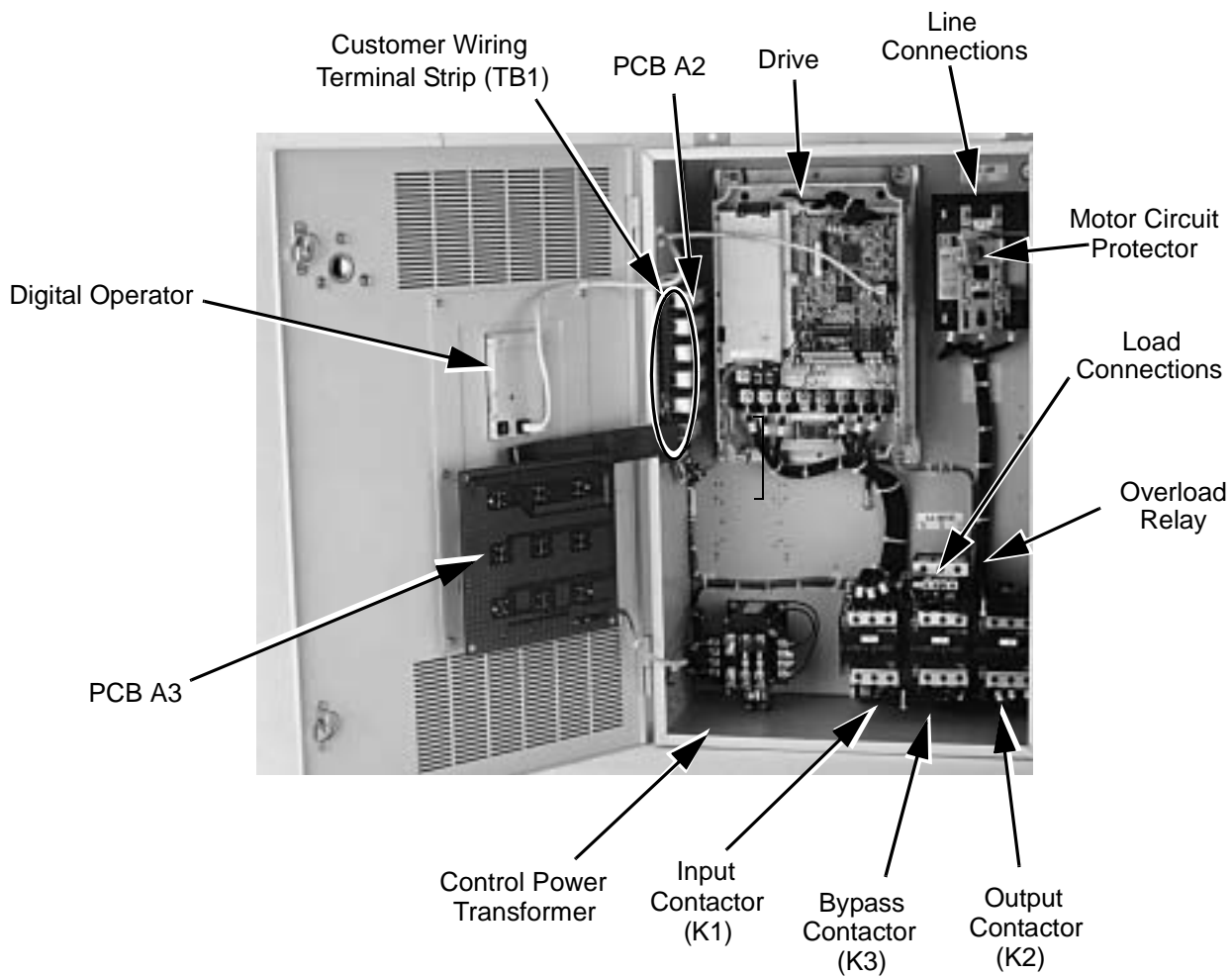
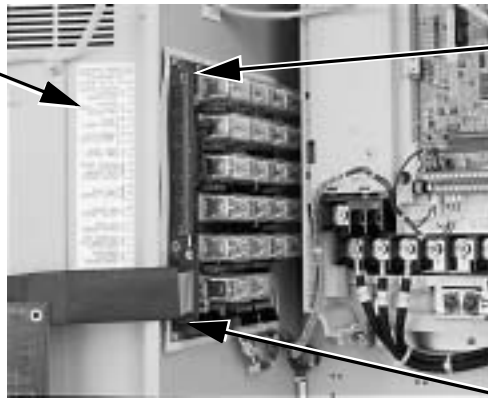

Fig 1.7 Internal Bypass Panel

TB1 Label Defining
Customer Control
Circuit Connection
Points



TB1 with Terminal Numbers
Printed on the PCB

Slide Switches for switch
selectable functions (Auto
Transfer, Remote Transfer and
Smoke Purge) are behind this
ribbon cable connector. See
Fig. 1.9 for details.

Fig 1.8 Control Terminal Strip

■ Contactors

The Bypass is a “3 contactor Bypass” circuit employing IEC rated contactors in an electrically interlocked arrangement to allow mutually exclusive operation in Drive or Bypass modes. To minimize enclosure space requirements, they are mounted in a 3 contactor assembly.

The control logic and “soft start” characteristic of the Drive limit the Drive input and output contactors to motor FLA current or less. For this reason, the Drive input and output contactors have lower current ratings than the Bypass contactor. The Bypass contactor is exposed to motor inrush current (LRA) when starting the motor across-the-line and therefore requires a higher current rating.

■ OverLoad Relay

The OverLoad Relay (OLR) is mounted to the contactor assembly or back panel (depending on rating), just above the Bypass contactor (see Figure 1.7). Electrically on the output power side of the Bypass unit, the adjustable thermal OLR provides overload protection for the motor in both the Drive and Bypass operating modes. The Bypass three phase output power connection to the motor is made to the output terminals of the overload relay. The OLR is set up in the factory to be a manual reset device, requiring operator attention if an overload trip-out is experienced.

■ Control Power Transformer

A Control Power Transformer (CPT) is provided to power the Bypass 120 VAC control circuit. The VA capacity is determined by the control circuit and optional functions specified for the unit. 100 VA of extra transformer capacity for customer control logic is provided in the standard unit and additional capacity is available as an “engineered” or “custom” option. The CPT primary is fused in both legs, the secondary is fused when required by NEC (above 350 VA). One side of the transformer secondary is grounded to the Bypass enclosure.

■ Relay and Selector Switch Logic

Operating elements such as indicating lights and selector switches, as well as the control relay logic, have been incorporated into a PCB assembly to eliminate the potential for loose wires after shipment and to control factory costs.

The operating elements are located on PCB A3, mounted to the inside of the enclosure door and ribbon cable connected to the control relay logic PCB A2.

The control relay logic PCB A2 is mounted to the left hand side of the enclosure and contains the control circuit field wiring terminal strip (TB1).

■ Drive/Bypass logic interlocks explained

The Bypass 120 VAC relay logic circuit is interconnected with the Drive multi-function digital input terminals and multi-function digital output terminals to allow a single customer interface to control both Drive and Bypass circuits. Some of these terminals are therefore not available for other field use.

Drive Multi-function input terminals:

Terminal S₁ receives the Drive run command from the 120 VAC relay logic circuit.

Terminal S₃ receives the Drive run enable signal from the 120 VAC relay logic circuit.

Terminal S₅ receives the Drive local/remote command from the 120 VAC relay logic circuit via the **HAND/OFF/AUTO** and **NORMAL/TEST** selector switch.

Drive Multi-function output terminals:

Terminals M₁ and M₂ are a normally open Drive run relay contact used to communicate the Drive operational mode to the 120 VAC relay logic circuit.

Terminals M₃ and M₄ are a normally open serial com. run status relay contact used to communicate the Drive operational state to the 120 VAC relay logic circuit.

Terminals M_A and M_C are a normally open Drive fault relay contact used to communicate the Drive fault status to the 120 VAC relay logic circuit.

■ PCB Jumpers explained

The S101 “Berg pin” jumper on the control relay logic PCB A2 is not for field use. It is employed only in the factory to enable the 2 motor “OR” configured option. It is removed when this option is present and must be in place when this option is not part of the unit specification (See Figure 1.9).

The S102 “Berg pin” jumper on the control relay logic PCB A2 is not for field use. It is employed only in the factory to enable the Run/Stop Push Button (3 wire control) configured option. It is removed when this option is present and must be in place when this option is not part of the unit specification (See Figure 1.9).

TB1 terminals 1 and 2 are jumpered (J1) as the unit is shipped from the factory. If a customer supplied series circuit of NC safety devices is to be used, this jumper is removed and the safety circuit connected between terminals 1 and 2.

TB1 terminals 5 and 6 are jumpered (J2) as the unit is shipped from the factory. If a customer supplied Drive NO enabling contacts are to be used (such as a damper end switch or occupied cycle timer), this jumper is removed and the enabling contacts wired between terminals 5 and 6.

■ Switch Selectable Functions:

The slide switches used to select these functions are located on the relay controller Printed Circuit Board (PCB) A2 (See Figure 1.9). The factory default is for these functions to be de-selected.

Smoke Purge: When enabled (switch S105) this function allows a contact closure, between terminals 17 and 18 of TB1, to transfer motor operation to bypass for a maximum capacity smoke control function. When in smoke purge mode, during emergency fire/smoke situations, the motor overloads and safety interlock circuit are overridden to shift the priority to protecting people rather than equipment.

Auto Transfer to Bypass: If enabled (switch S103), the P7 Bypass unit will automatically transfer the motor operation from Drive to Bypass in the event of a Drive fault. When the Drive fault condition has cleared, this function is reset by moving the H/O/A switch to the **OFF** position, waiting for the keypad to go blank, then switching back to the **DRIVE** position.

IMPORTANT

Before selecting this function in fan applications, care must be taken to ensure that the duct-work is designed to handle the pressure resulting from full speed operation with the VAV terminal unit dampers at minimum position or closed.

Remote Transfer to Bypass: When selected (switch S104) this function allows a contact closure from a separate source, between terminals 25 and 26 of TB1, to transfer motor operation from Drive mode to Bypass mode. This remote transfer to Bypass function overrides the **DRIVE/BYPASS** manual switch.

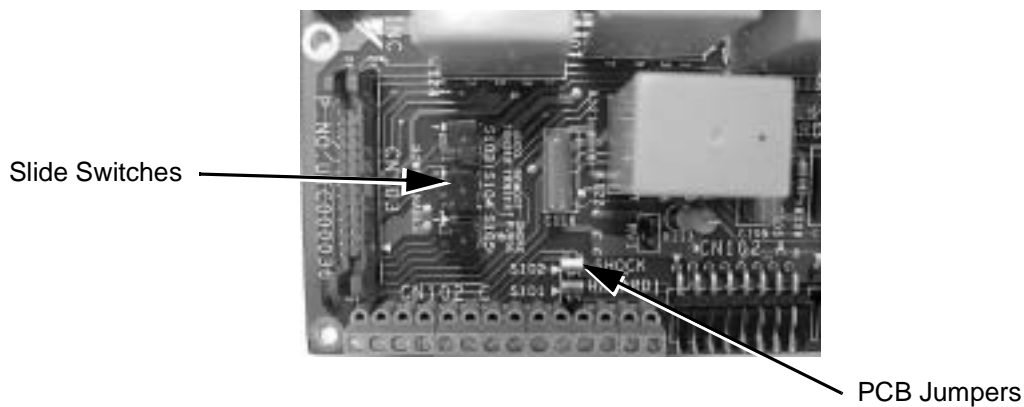

Fig 1.9 Printed Circuit Board A2

Exterior and Mounting Dimensions

◆ Bypass Unit 30 HP and Below, 480 VAC; 15 HP and Below, 208V/240V

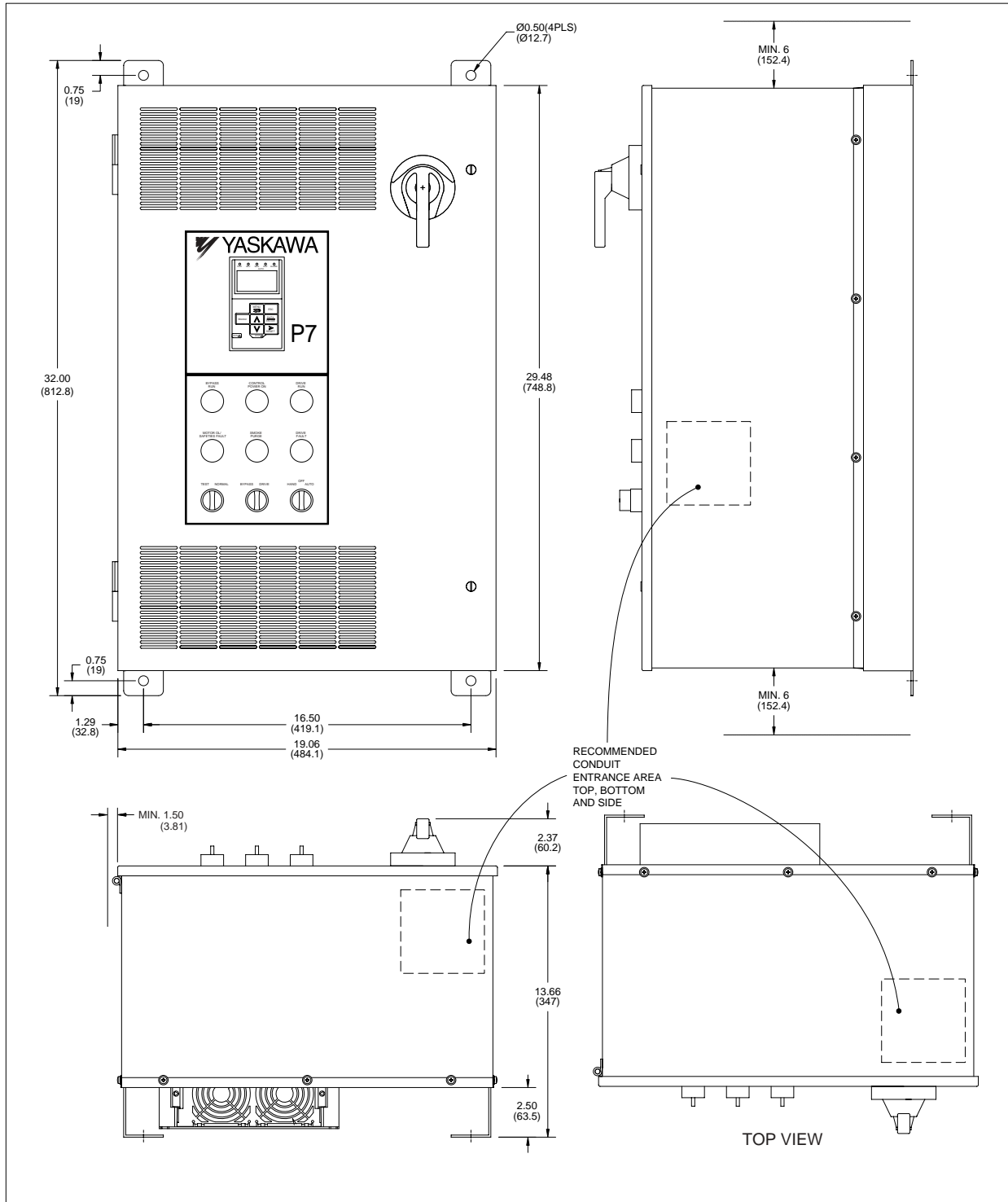

Fig 1.10 Enclosure 1 for up to 30HP, 480 VAC
NEMA 1 and NEMA 12 FVFF Enclosures

◆ Bypass Unit 40 HP to 100 HP, 480 VAC; 20 HP to 40 HP, 208V/240V

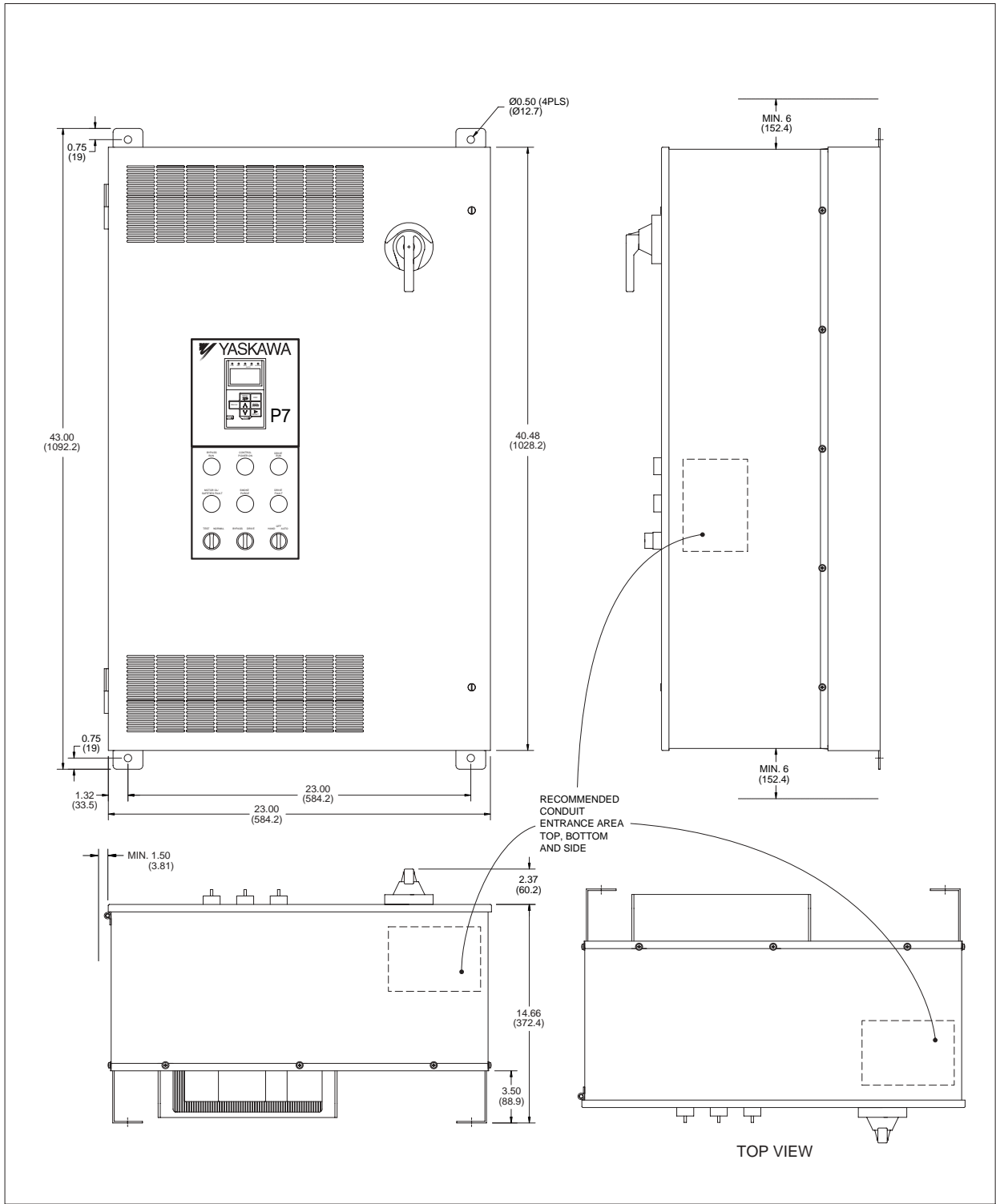
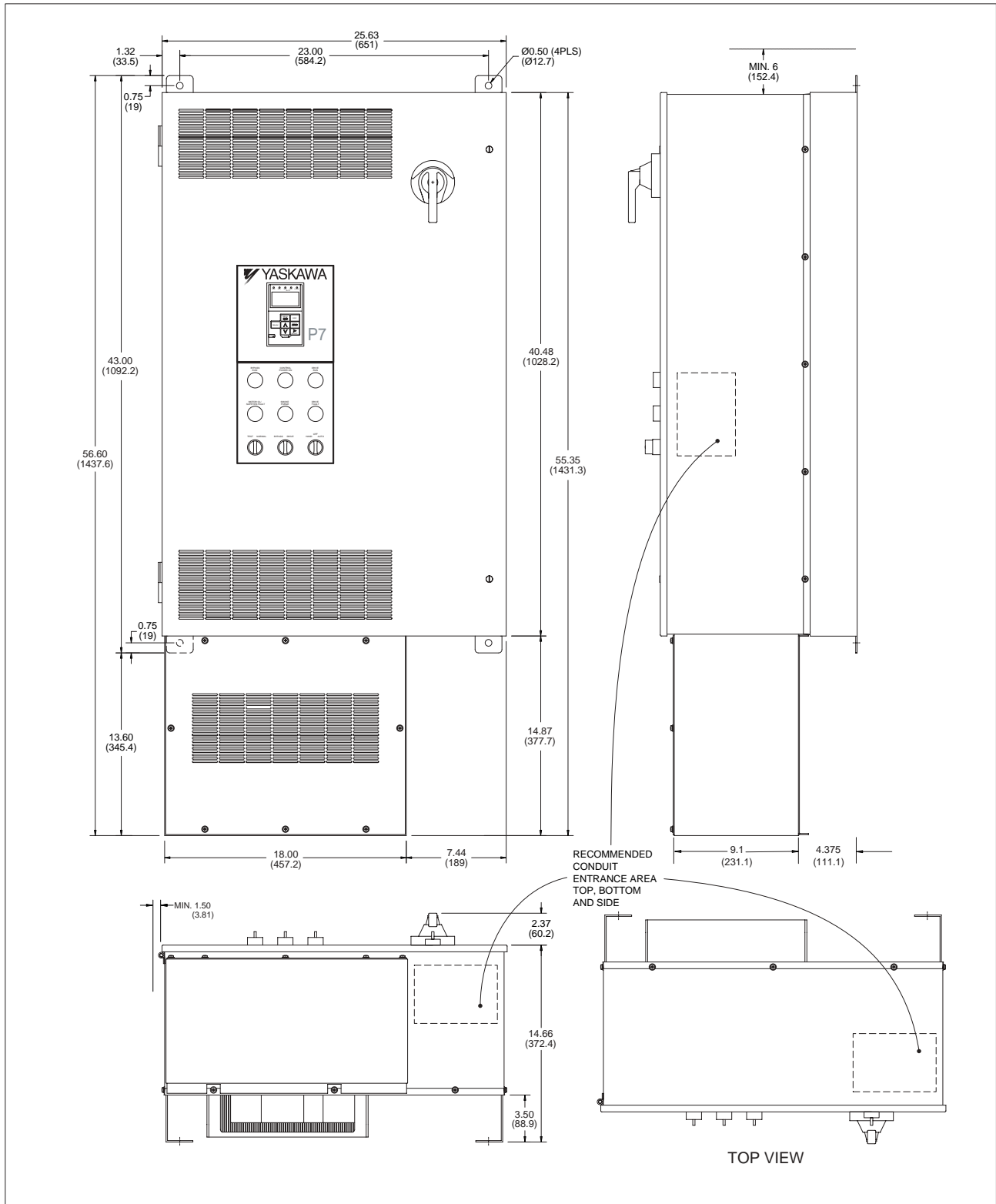

Fig 1.12 Enclosure 2, for 40HP to 100HP, 480 VAC
NEMA 1 and NEMA 12 FVFF Enclosures

◆ Bypass Unit 40 HP to 100 HP, 480 VAC; 20 HP to 40 HP, 208V/240V
With Add-On Box



DIMENSIONS IN INCHES (MM), FOR REFERENCE ONLY

Fig 1.13 Enclosure 2, with Options Extension, for up to 40HP to 75HP, 480 VAC
NEMA 1 and NEMA 12 FVFF Enclosures

◆ Bypass Unit 125 HP to 250 HP, 480 VAC; 50 HP to 125 HP, 208V

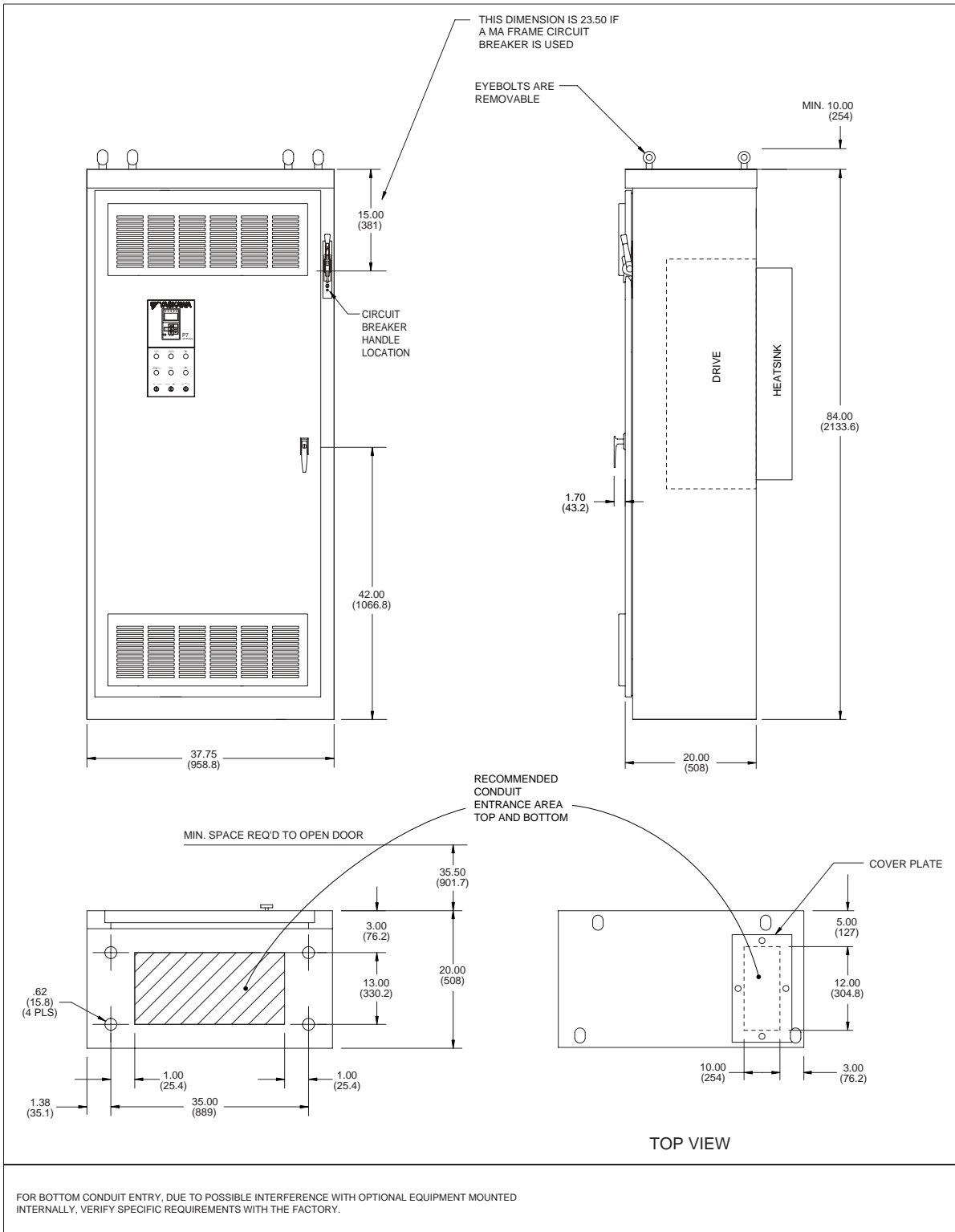

Fig 1.14 Enclosure F1, for 125HP to 250HP, 480 VAC
NEMA 1 and NEMA FVFF 12 Enclosures

◆ Dimensions and Weights

Table 1.6 Bypass Dimensions and Weights

Rated Input Voltage	Continuous Output Current (Amps)	Nominal HP ⁽¹⁾	Bypass ----	NEMA 1 and NEMA 12 Dimensions inches (mm)			Wall Mounting Dimensions H x W	Drawing Number	Drawing Number (w/ Add-on Box) ⁽³⁾	Weight (lbs) ⁽⁴⁾
				Height ⁽²⁾	Width	Depth				
208V	2.4	1/2	D002	32.00 (812.8)	19.06 (484.1)	16.03 (407.2)	30.5 x 16.5 (774.7) x (419.1)	S-5542	S-5543	115
	3.5	3/4	D003							
	4.6	1	D004							
	7.5	2	D007							
	10.6	3	D010							
	16.7	5	D016							
	24.2	7.5	D024	43.00 (1092.2)	25.63 (651.0)	17.03 (432.6)	41.5 x 23.0 (1054.1 x 584.2)	S-5544	S-5545	127
	30.8	10	D030							
	46.2	15	D046							
	59.4	20	D059							
	74.8	25	D074	84.00 (2133.6)	37.75 (958.9)	21.7 (551.2)	Floor Mount W x D 35.0 x 13.0 (889 x 330.0)	S-5550	N/A	208
	88	30	D088							
	114	40	D114							
	143	50	D143							
	169	60	D169							
	211	75	D211							
273	100	D273	84.00 (2133.6)	37.75 (958.9)	21.7 (551.2)	Floor Mount W x D 35.0 x 13.0 (889 x 330.0)	S-5550	N/A	847	
343	125	D343								
396	150	D396								
240V	2.2	1/2	A002	32.00 (812.8)	19.06 (484.1)	16.03 (407.2)	30.5 x 16.5 (774.7) x (419.1)	S-5542	S-5543	115
	3.2	3/4	A003							
	4.0	1	A004							
	6.8	2	A006							
	9.6	3	A009							
	15.2	5	A015							
	22	7.5	A022	43.00 (1092.2)	25.63 (651.0)	17.03 (432.6)	41.5 x 23.0 (1054.1 x 584.2)	S-5544	S-5545	127
	28	10	A028							
	42	15	A042							
	54	20	A054							
68	25	A068	84.00 (2133.6)	37.75 (958.9)	21.7 (551.2)	Floor Mount W x D 35.0 x 13.0 (889 x 330.0)	S-5550	N/A	208	
80	30	A080								
104	40	A104								
230V	130	50	A130	84.00 (2133.6)	37.75 (958.9)	21.7 (551.2)	Floor Mount W x D 35.0 x 13.0 (889 x 330.0)	S-5550	N/A	847
	154	60	A154							
	192	75	A192							
	248	100	A248							
	312	125	A312							
	360	150	A360							

(1) Horsepower rating is based on standard NEMA B 4-pole motor design

(2) Height dimension includes the mounting screw tabs.

(3) Add-on box adds 13.6 inches to Height dimension and 91 lbs. Max. to total

(4) Data represents the total weight of the Drive with all possible standard options, not shipping weight.

Table 1.6 Bypass Dimensions and Weights (Continued)

Rated Input Voltage	Continuous Output Current (Amps)	Nominal HP ⁽¹⁾	Bypass ----	NEMA 1 and NEMA 12 Dimensions inches (mm)			Wall Mounting Dimensions H x W	Drawing Number	Drawing Number (w/ Add-on Box) ⁽³⁾	Weight (lbs) ⁽⁴⁾
				Height ⁽²⁾	Width	Depth				
480V	1.1	1/2	B001	32.00 (812.8)	19.06 (484.1)	16.03 (407.2)	30.5 x 16.5 (774.7) x (419.1)	S-5542	S-5543	115
	1.6	3/4								
	2.1	1	B002							
	3.4	2	B003							
	4.8	3	B004							
	7.6	5	B007							
	11	7.5	B011							
	14	10	B014							
	21	15	B021	43.00 (1092.2)	25.63 (651.0)	17.03 (432.6)	41.5 x 23.0 (1054.1 x 584.2)	S-5544	S-5545	127
	27	20	B027							
	34	25	B034							
	40	30	B040							
	52	40	B052	84.00 (2133.6)	37.75 (958.9)	21.7 (551.2)	Floor Mount W x D 35.0 x 13.0 (889 x 330.0)	S-5550	N/A	142
	65	50	B065							
	77	60	B077							
	96	75	B096							
124	100	B124								203
156	125	B156								232
180	150	B180								241
240	200	B240								943
302	250	B302								1240
										1352

- (1) Horsepower rating is based on standard NEMA B 4-pole motor design
- (2) Height dimension includes the mounting screw tabs.
- (3) Add-on box adds 13.6 inches to Height dimension and 91 lbs. Max. to total
- (4) Data represents the total weight of the drive with all possible standard options, not shipping weight.

Checking and Controlling Installation Site

Install the Bypass unit as described below and maintain the specified operating conditions.

◆ Installation Site

Location of the Bypass unit is important to achieving proper performance and design operating life. Install the Bypass unit as close as possible to the motor. The NEMA type 1 & 12 enclosed units should be installed in an area where it will be protected from: Direct sunlight, rain or moisture, corrosive gasses or liquids, vibration and dust or metallic particles. The ambient air available for cooling the unit should be 104° F (40° C) or less.

Wall mount units require a minimum 6 inch clearance above and below, to achieve adequate heat sink cooling. When the add-on box is employed for optional equipment, no additional bottom clearance is required.

No side clearance is required for cooling because the cooling air flow is in and out of the enclosure door at the front surface of the unit (do not block the air flow louvers). Clearance for the opening swing of the enclosure door should be considered when placing these units. The door is hinged on the left and must open through at least a 90 degree swing with a 120 to 180 degree swing being preferable (minimum clearance is 1.5”).

Floor mounted units require a minimum clearance of 10 inches above the enclosure to allow for air flow over the heat sink fins.

Install the Bypass unit under the following conditions in UL pollution degree 1 & 2 environments. This excludes wet locations where surfaces may become conductive due to moisture and contaminant loading.

Type	Ambient Operating Temperature	Humidity	Plenum Rated
NEMA Type 1 & 12	14 to 104°F (-10 to + 40°C)	95% RH or less (no condensation)	Yes

Observe the following precautions when mounting the Bypass unit.

- Install the Bypass unit in a clean location that is free from oil mist and dust.
- Install the Bypass unit in an environment where metal shavings, oil, water, or other foreign matter will not get into the Bypass enclosure.
- Install the Bypass unit in a location free from radioactive materials.
- Install the Bypass unit in a location free from harmful gasses and liquids.
- Install the Bypass unit in a location without excessive vibration.
- Install the Bypass unit in a location free from chlorides.
- Install the Bypass unit in a location not in direct sunlight.
- Install the Bypass unit on a non-combustible surface.

◆ Controlling the Ambient Temperature

To enhance the reliability of operation, the Bypass unit should be installed in an environment free from extreme temperature variations. Do not store this Technical Manual or any other documents on the top surface of the Bypass unit, they may cover the heat sink cooling air discharge opening and cause the unit to overheat.

If the Bypass unit is installed in an enclosure (such as an electrical control box in an air handling unit), use a cooling fan or air conditioner to maintain the Bypass unit internal air temperature below 113°F (45°C).

◆ Protecting the Bypass Unit from Foreign Matter

During Bypass unit installation and project construction, it is possible to have foreign matter, such as metal shavings or wire clippings, fall inside the Bypass unit. To prevent foreign matter from falling into the Bypass unit, place a temporary cover over the unit.

Always remove the temporary cover from the Bypass unit before start-up. Otherwise, ventilation will be reduced, causing the Bypass unit to overheat.

◆ Installation Orientation and Enclosure Considerations

Install the Bypass unit vertically so as not to reduce the cooling efficiency. When installing the Bypass unit, always provide the recommended installation clearances to allow normal heat dissipation.

When preparing to mount the unit, lift it by the base (or lifting rings when provided), never by the enclosure door. For effective cooling and proper maintenance, the wall mounted units must be installed on a flat non-flammable vertical surface using four mounting screws.

To mount units employing the add-on box, a hex head mounting screw and socket wrench will be required for the lower left mounting hole location. See Figure 1.15.

For all units, the MCP handle should be in the OFF position to open the enclosure door. The wall mount units have two full turn fasteners, CCW to open, that require a flat blade screwdriver to open the enclosure door.



Fig 1.15 Add-on Options Box

Chapter 2

Electrical Installation

This chapter describes wiring and the electrical installation process for a Drive and Bypass unit.

Termination Configuration - Power Wiring	2
Field Wiring, Pressure Wire Connector, Wire Type, Range and Tightening Torque Specifications	3
Cable Length between Drive and Motor	4
Grounding	5
Wire Routing	6
Drive Main Circuit Configurations 208-240 VAC	7
Drive Main Circuit Configurations 480 VAC	8
Control Wiring	9
Bypass Field Control Wire Landing	9
Annunciation Contacts	9
Damper Control Circuit	10
Customer Supplied Run/Stop circuit:	10
Safety Interlock Circuit:	10
Customer Supplied Interlock Circuit (Drive and Bypass enable input):	10
Switch Selectable Functions:	10
Bypass Relay Controller PCB	11
Drive Speed Control Circuit Wiring	12
Drive Terminal Block Configuration	13
Wiring Checks	14
Control Circuit Wiring Precautions	14
Bypass Control Circuit Terminal Functions	15
DIP Switch S1	16
Shunt Connector CN15	17
Field Wiring Diagram	18
Wiring Diagram	20
Logic Diagram	22

Termination Configuration - Power Wiring

The Circuit Breaker/MCP is located in the upper right hand side of the Bypass unit. The Bypass three phase input power connection is made to the input terminals of the MCP. See Figure 2.1 and 2.2 for representative examples.

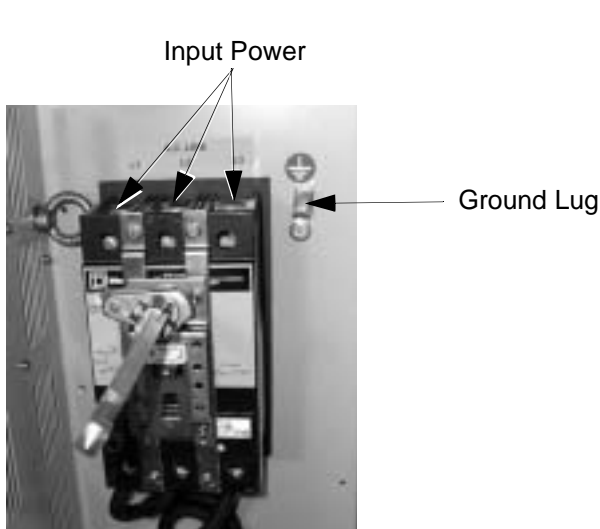

Fig 2.1 Typical Input Power Connection, Wall Mount Unit

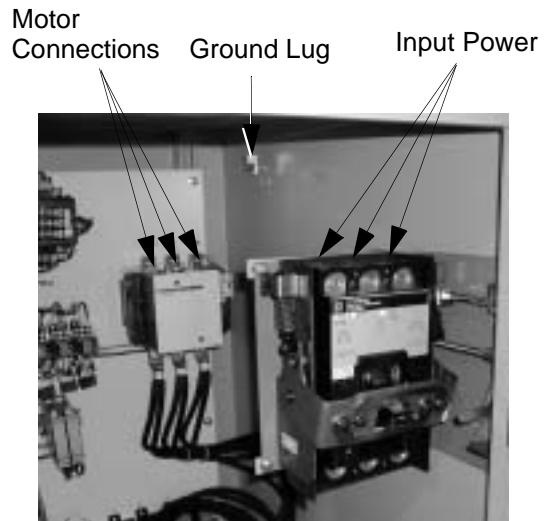

Fig. 2.2 Typical Input and Output Power Connections, Floor Mount Unit

The OverLoad Relay (OLR) is mounted to the contactor assembly or back panel (depending on rating), just above the bypass contactor. The Bypass three phase output power connection to the motor is made to the output terminals of the OverLoad Relay. See Figure 2.3 for representative examples.

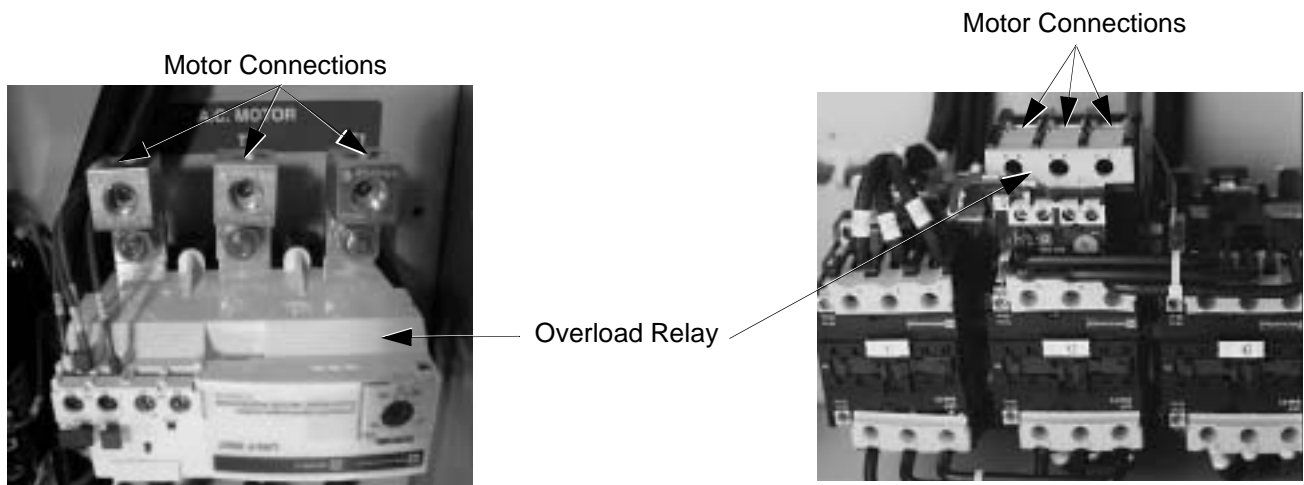

Fig 2.3 Typical Output Power Connection, Wall Mount Units

◆ Field Wiring, Pressure Wire Connector, Wire Type, Range and Tightening Torque Specifications

BYPASS MODEL NO. BASE NUMBER ----XXXX*		CUSTOMER A.C. LINE WIRING					CUSTOMER EARTH GROUND WIRING	
		CIRCUIT BREAKER			GROUND LUG			
208V	240V	480V	MFG. PART NUMBER	CURRENT RATING (AMPS)	WIRE SIZE RANGE (AWG)	TIGHTENING TORQUE (LB.-IN.)	WIRE SIZE RANGE (AWG)	TIGHTENING TORQUE (LB.-IN.)
D002	A002	B001	FAL36003	3	14 - 4	35	14 - 10	35
D002	A003	B002	FAL36007	7	14 - 4	35		
D003	A004	B003						
D004		B004						
D007	A006	B007	FAL36015	15	14 - 4	35		
D010	A009	B011						
D016	A015	B014	FAL36030	30	12 - 4	35		
D024	A022	B021	FAL36050	50	12 - 1/0	80		
D030	A028	B027						
		B034						
D046	A042	B040	FAL36100	100	12 - 1/0	80	8	40
D059	A054	B052						
	A068	B065						
		B077						
D074	A080	B096	KAL36150	150	4 - 350 kcmil	250	6 - 4	45
D088	A104	B124						
D114	A130	B124	KAL36250	250	4 - 350 kcmil	250		
D143	A154	B156					4 - 2/0	120
D169	A192	B180						
D211	A248	B240	LAL36400	400	1 x (1-600 kcmil)	375		
D273		B302			2 x (1-250 kcmil)	2 x 375		
D343	A312	B361	MAL36600	600	(1-3) x (3/0-500 kcmil)	(1-3) x 300		
D396	A360	B414						
		B477	MAL36800	800	(1-3) x (3/0-500 kcmil)	(1-3) x 300		
		B515						
		B590						

BYPASS MODEL NO. BASE NUMBER ----XXXX*		CUSTOMER A.C. MOTOR WIRING									
		STANDARD BYPASS OVERLOAD RELAY			OR, WITH OPTION A OVERLOAD RELAYS			OR, WITH OPTION D A.C. CONTACTORS			
208V	240V	480V	MFG. PART NUMBER	WIRE SIZE RANGE (AWG)	TIGHTENING TORQUE (LB.-IN.)	MFG. PART NUMBER	WIRE SIZE RANGE (AWG)	TIGHTENING TORQUE (LB.-IN.)	MFG. PART NUMBER	WIRE SIZE RANGE (AWG)	TIGHTENING TORQUE (LB.-IN.)
D002	A002	B001	LR2 D13	18 - 10	15	LR2 D13	18 - 10	15	LC1 D09	18 - 10	7
		B002									
D003	A003	B003	LR2 D15	18 - 10	15						
D004	A004	B004									
D007	A006	B007	LR2 D15	18 - 10	15	LR2 D15	18 - 10	15	LC1 D18	18 - 8	15
D010	A009	B011									
D016	A015	B014									
D024	A022	B021	LR2 D15	18 - 10	15	LR2 D15	18 - 10	15	LC1 D25	18 - 8	15
D030	A028	B027	LR2 D25	14 - 6	15	LR2 D15	18 - 10	15	LC1 D32	14 - 6	20
		B034	LR2 D35	10 - 1/0	75	LR2 D15	18 - 10	15	LC1 D40	10 - 3	45
		B040									
D046	A042		LR2 D35	10 - 1/0	75	LR2 D15	18 - 10	15	LC1 D50	10 - 3	45
		B052	LR2 D35	10 - 1/0	75	LR2 D25	14 - 6	15			
D059	A054		LR2 D35	10 - 1/0	75	LR2 D25	14 - 6	15	LC1 D65	10 - 3	45
		B065	LR2 D35	10 - 1/0	75	LR2 D35	10 - 1/0	75			
		A068	LR2 D35	10 - 1/0	75	LR2 D35	10 - 1/0	75	LC1 D80	10 - 2	100
D074	A080	B077	LR2 D3563	10 - 1/0	100						
D088		B096	LR9 F5567	6 - 3/0	200	LR2 D35	10 - 1/0	75	LC1 D115	8 - 250 kcmil	100
		A104	LR9 F5569	6 - 3/0	200						
D114	A130	B124	LR9 F5569	6 - 3/0	200	LR2 D35	10 - 1/0	75	LC1 D150	8 - 250 kcmil	100
D143			LR9 F5569	6 - 3/0	200	LR2 D35	10 - 1/0	75	LC1 F185	6 - 3/0	200
		A154	LR9 F5571	6 - 300 kcmil	275						
D169	A180	B180	LR9 F5571	6 - 300 kcmil	275	LR9 F5567	6 - 3/0	200	LC1 F265	6 - 300 kcmil	275
D211	A248	B240	LR9 F7575	2 x (6-300 kcmil)	2 x 500	LR9 F5569	6 - 3/0	200	LC1 F330	6 - 300 kcmil	275
D273			LR9 F7575	2 x (6-300 kcmil)	2 x 500	LR9 F5569	6 - 3/0	200	LC1 F400	4 - 500 kcmil	500
		B302	LR9 F7579	2 x (6-300 kcmil)	2 x 500	LR9 F5569	6 - 3/0	200			
		A312	LR9 F7579	2 x (6-300 kcmil)	2 x 500	LR9 F5571	6 - 300 kcmil	275			
D343	A360	B361	LR9 F7579	2 x (6-300 kcmil)	2 x 500	LR9 F5571	6 - 300 kcmil	275	LC1 F500	2 x (2-600 kcmil)	2 x 500
D396											
		B414	LR9 F7581	3 x (6-300 kcmil)	3 x 500						
		B477	LR9 F7581	3 x (6-300 kcmil)	3 x 500	LR9 F7575	2 x (6-300 kcmil)	2 x 500			
		B515	LR9 F7581	3 x (6-300 kcmil)	3 x 500	LR9 F7575	2 x (6-300 kcmil)	2 x 500	LC1 F630	3 x (2-600 kcmil)	3 x 500
		B590									

* The fourth underscore position in these model numbers codes for the enclosure type: V = NEMA1, B = NEMA12 FVFF.

FOR 0 TO 100 AMPS, USE 60 - 75 C COPPER WIRE, AND ABOVE 100 AMPS, USE 75 C COPPER WIRE.

IMPORTANT

Determine the wire size for the main circuit so that line voltage drop is within 2% of the rated voltage. Line voltage drop is calculated as follows:

$$\text{Line voltage drop (V)} = \sqrt{3} \times \text{wire resistance } (\Omega/\text{km}) \times \text{wire length (m)} \times \text{current (A)} \times 10^{-3}$$

WARNING

Prior to removing any protective cover or wiring any part of the Drive, remove all power sources, including main input power and control circuit power. Wait a minimum of 5 minutes after power removal, before removing any cover. The charge lamp located within the Drive should be off prior to working inside. Even if the charge lamp is off, one must measure the AC input, output, and DC Bus potential to insure safe levels prior to resuming work. Failure to adhere to this warning may result in personal injury or death.

◆ Cable Length between Drive and Motor

The Bypass unit should be installed as close as possible to the motor to minimize the length of load side power cable needed between the Drive and the motor. If the cable between the Drive and the motor is long, the high-frequency leakage current will increase, causing the Drive output current to increase as well. This may affect peripheral devices. To prevent this, reduce cable length, or if necessary, adjust the carrier frequency (set in C6-02) as shown in Table 2.1.

The line side power cables, load side power cables and the control wiring should all be run in a separate conduit. Careful attention to this recommended design practice will avoid many potential motor and Drive related problems.

Motor Cable Length	164 ft. (50m) maximum	328 ft. (100m) maximum	More than 328 ft.(100m)
Carrier Frequency	15kHz maximum	10kHz maximum	5kHz maximum

(See the limitations on carrier frequency, based on Drive capacity and model number in Appendix B).

◆ Grounding

■ Drive and Motor Ground Wire Landing

The Drive ground lug (terminal $\frac{\perp}{\equiv}$) is connected to the enclosure. The enclosure ground lug must be connected to earth ground. See Figures 2.1 and 2.2.

The Drive has a second ground lug to accept the motor ground lead. See Figure 2.9.

■ Ground Wiring Precautions

Observe the following precautions when connecting the ground wire:

1. 208-240 VAC Drives should have a ground connection with resistance of less than 100 Ω .
2. 480 VAC Drives should have a ground connection with resistance of less than 10 Ω .
3. Do not share the ground wire with other devices, such as large-current electrical equipment.
4. Always use a ground wire that complies with technical standards on electrical equipment and minimize the length of the ground wire. Leakage current flows through the Drive. Therefore, if the distance between the ground rod and the ground terminal is too long, potential on the ground terminal of the Drive will become unstable.
5. When using more than one Drive, be careful not to loop the ground wire.



Fig 2.4 Ground Wiring Examples

For grounding connection to earth ground see Figures 2.1 and 2.2.

■ Control Circuit Ground Terminals

The removable Drive control terminal card provides two ground terminals (marked TB3 and TB4) to accept the control wire shield connection. The control wire shield should be connected on this end only, the opposite end should be isolated with electrical tape.

IMPORTANT

Grounding of the Bypass enclosure and motor is required for proper system operation.

◆ Wire Routing

The following Figures indicate suggested wire entry and bending areas for representative wall mount enclosures.

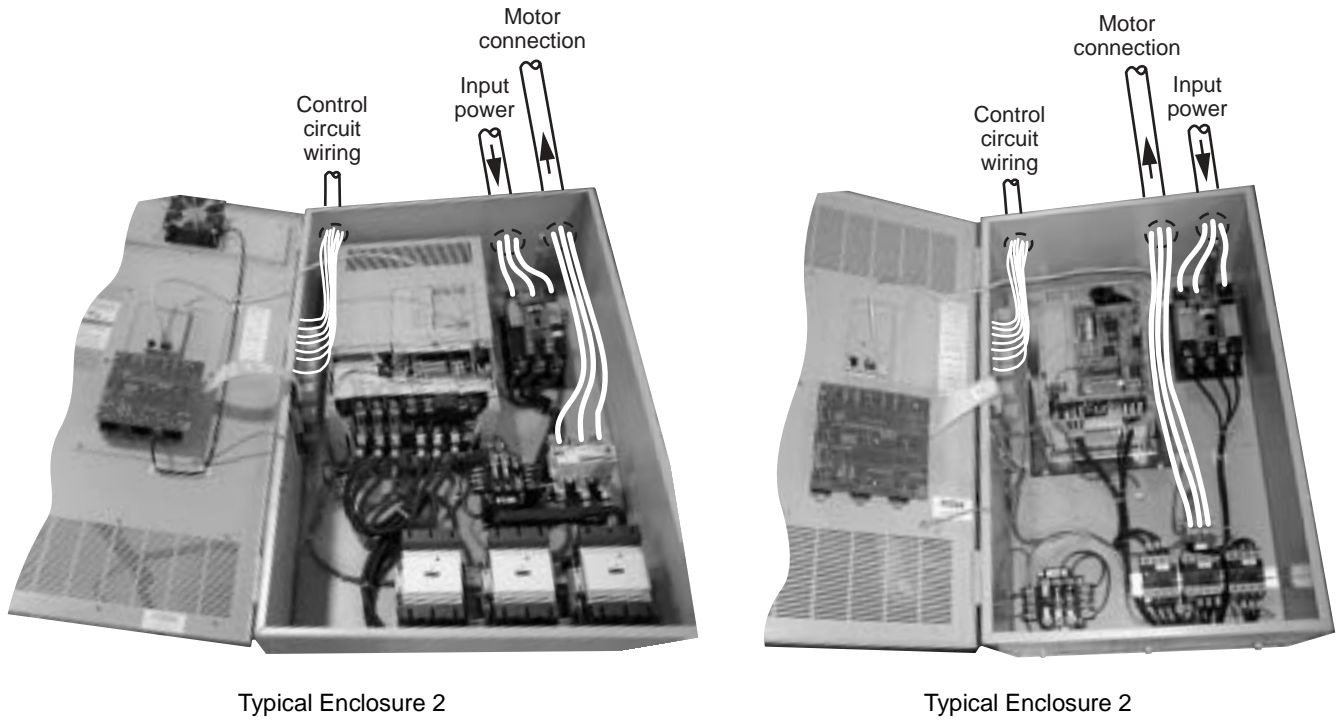

Fig 2.5 Wall Mount Enclosures

◆ Drive Main Circuit Configurations 208-240 VAC

The main circuit configurations of the Drive are shown in Tables 2.2 and 2.3.

Table 2.2 Drive Main Circuit Configurations 208-240 VAC	
<p>CIMR-____ 20P4 to 2018 (1/2 Hp to 25 Hp)</p> <p>Note 1</p>	<p>CIMR-____ 2022 and 2030 (30 Hp to 40 Hp)</p> <p>Notes 1 & 3</p>
<p>CIMR-____ 2037 to 2110 (50 Hp to 150 Hp)</p> <p>Notes 1 & 3</p>	<p>---</p>
<p>Note 1. Input fuses or molded case circuit breakers are required for proper branch circuit protection for all Drives. Failure to use recommended fuses/circuit breakers (See Appendix E) may result in damage to the wiring, Drive and/or personal injury.</p> <p>2. Control power is supplied internally from the main circuit DC power supply for all Drives.</p> <p>3. Consult your Yaskawa representative before using 12-pulse rectification.</p>	

◆ P7 Drive Main Circuit Configurations 480 VAC

Table 2.3 Drive Main Circuit Configurations	
480 VAC	
<p style="text-align: center;">CIMR-___ 40P4 to 4018 (1/2 Hp to 30 Hp)</p> <p>Note 1</p>	<p style="text-align: center;">CIMR-___ 4030 to 4055 (40 Hp to 100 Hp)</p> <p>Notes 1 & 3</p>
<p style="text-align: center;">CIMR-___ 4075 to 4160 and CIMR-___ 4185 to 4300 (125 Hp to 500 Hp)</p> <p>Notes 1 & 3</p>	<p style="text-align: center;">---</p>
<p>Note 1. Input fuses or molded case circuit breakers are required for proper branch circuit protection for all Drives. Failure to use recommended fuses/circuit breakers (See Appendix E) may result in damage to the wiring, Drive and/or personal injury.</p> <p>2. Control power is supplied internally from the main circuit DC power supply for all Drives.</p> <p>3. Consult your Yaskawa representative before using 12-pulse rectification.</p>	

Control Wiring

◆ Bypass Field Control Wire Landing

The Bypass field control wiring is terminated on the relay control PCB A2, Terminal block TB1. The terminal designations are labeled on the door, adjacent to PCB A2 (see Figure 2.6). Route the control wiring as shown in Figure 2.5.

TB1 terminals 1 and 2 are jumpered (J1) as the unit is shipped from the factory. If a customer supplied series circuit of NC safety devices is to be used, this jumper is removed and the safety circuit connected between terminals 1 and 2.

TB1 terminals 5 and 6 are jumpered (J2) as the unit is shipped from the factory. If customer supplied Drive NO enabling contacts (open = Drive disabled, closed = Drive enabled) are to be used (such as a damper end switch or occupied cycle timer), this jumper is removed and the enabling contacts wired between terminals 5 and 6.

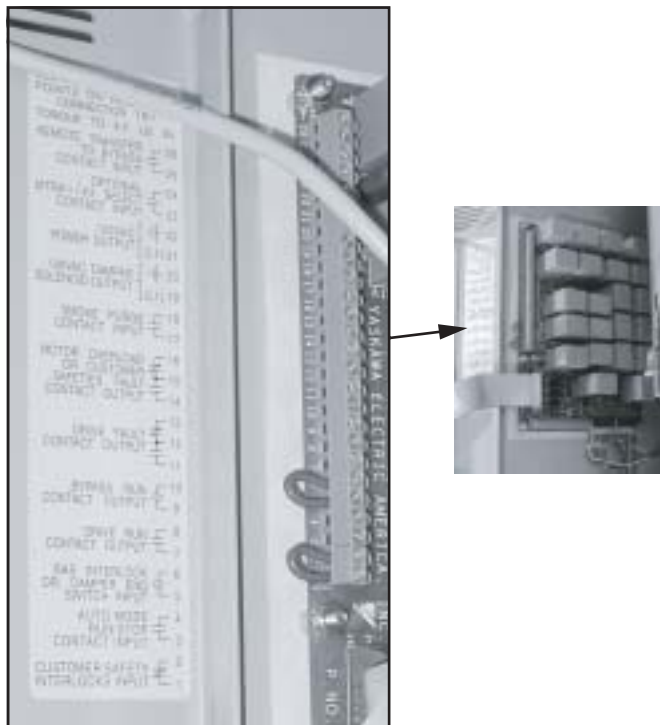

Fig 2.6 TB1 Control Terminal Locations, All Models

◆ Annunciation Contacts

Contacts for customer use are provided and wired to TB1 as follows for use as annunciators of Bypass unit operation. All are 1 amp at 120 VAC contacts.

Table 2.4 Annunciation Contacts		
Function	Type	TB1 Terminals
Motor OL/Safeties Fault	Form C	14-15-16
Bypass Run	Form A	9-10
Drive Run	Form A	7-8
Drive Fault	Form C	11-12-13

◆ Damper Control Circuit

TB1 terminals 19 and 20 are provided to power a customer supplied 120 VAC relay, electric actuator or electro-pneumatic solenoid air valve employed to control a pneumatic damper actuator, typically for outdoor air intake damper interlock. The power rating of the connected device should be no more than 40 VA continuous and 70 VA inrush. An off command (from the H/O/A switch) or a safety device trip-out will immediately de-energize these terminals. At the same time the Drive will begin the ramp to stop process (in Drive mode with the default stopping method). In some air handling unit applications operation during the ramp to stop time with the dampers closed may be problematic. Over pressurization of ducts or trip-out on high DC bus voltage, due to overhauling of the load by other fans in the system, are possible outcomes. One solution is to reprogram the stopping method in parameter b1-03 to “coast to stop” eliminating the potential for both of these problems.

◆ Customer Supplied Run/Stop circuit:

A control terminal block position (TB1, terminals 3 and 4) is provided to connect the Normally Open (NO) Run/Stop contact from a separate source or other remote controller for auto mode control.

There must be continuity between these terminals in order for the motor to run.

◆ Safety Interlock Circuit:

A control terminal block position (TB1, terminals 1 and 2) is provided to connect the series circuit of Normally Closed (NC) safety devices such as: freeze up thermostats, smoke/fire sensors, high pressure limits, temperature limits or vibration detectors.

There must be continuity between these terminals in order for the motor to run.

◆ Customer Supplied Interlock Circuit (Drive and Bypass enable input):

A control terminal block position (TB1, terminals 5 and 6) is provided to connect Normally Open (NO) enabling contacts such as: damper end switches or occupied cycle timers.

There must be continuity between these terminals in order for the motor to run.

◆ Switch Selectable Functions:

The slide switches used to select these functions are located on the relay controller Printed Circuit Board (PCB) A2 (See Figure 1.9). The factory default is for these functions to be de-selected.

Smoke Purge: When enabled (switch S105) this function allows a contact closure, between terminals 17 and 18 of TB1, to transfer motor operation to bypass for a maximum capacity smoke control function. When in smoke purge mode, during emergency fire/smoke situations, the motor overloads and safety interlock circuit are overridden to shift the priority to protecting people rather than equipment.

Remote Transfer to Bypass: When selected (switch S104) this function allows a contact closure from a separate source, between terminals 25 and 26 of TB1, to transfer motor operation from Drive mode to bypass mode. This remote transfer to bypass function overrides the Drive/Bypass manual switch.

◆ Bypass Relay Controller PCB

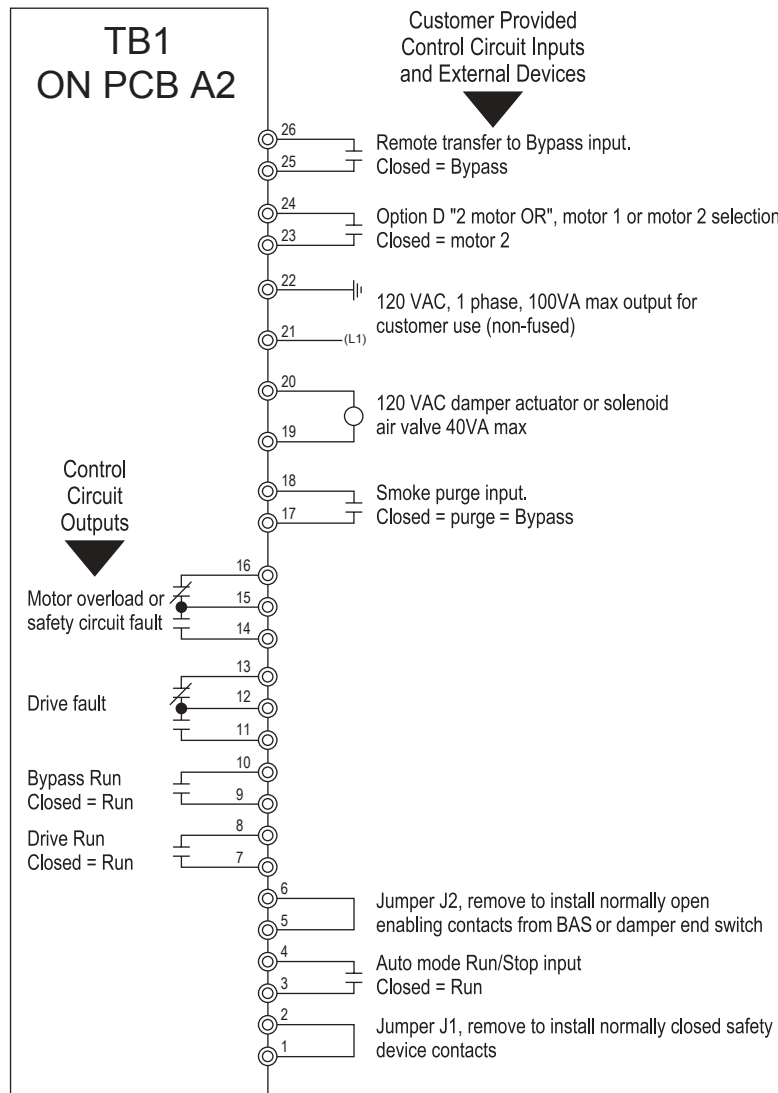

Fig 2.7 Bypass Control Circuit Inputs and Outputs

Customer provided contact closure inputs must have a minimum rating of 0.1 amp at 120 VAC.

◆ Drive Speed Control Circuit Wiring

The auto mode speed reference (speed command) field wiring connection is made directly to Drive terminals A2 (signal positive), AC (signal common) and G (shield). Keep this lead length as short as possible to maintain signal quality. Insulated twisted shielded pair wire (2 conductor # 18 ga, Belden 8760 or equivalent) is required. Do not run these wires in the same conduits as other AC power or control wires. The shield must be connected on this end only, stub and isolate the other end. The signal employed is 4 to 20 mA with parameter H3-08 set for “2: 4 - 20 mA”. For 0 to 10 VDC, parameter H3-08 is set for “0: 0 - 10 VDC” and the P7 control board DIP switch S1-2 must be in the OFF position. (See Figure 2.11)

For remote operation, keep the length of the control wiring to 50 m or less. Separate the control wiring from high-power lines (input power, motor leads or relay sequence circuits) to reduce induction from peripheral devices.

When setting speed commands from an external speed potentiometer (and not from a Digital Operator), use shielded twisted-pair wires and ground the shield to terminal E(G), as shown in Figure 2.8. Terminal numbers and wire sizes are shown in Table 2.5.

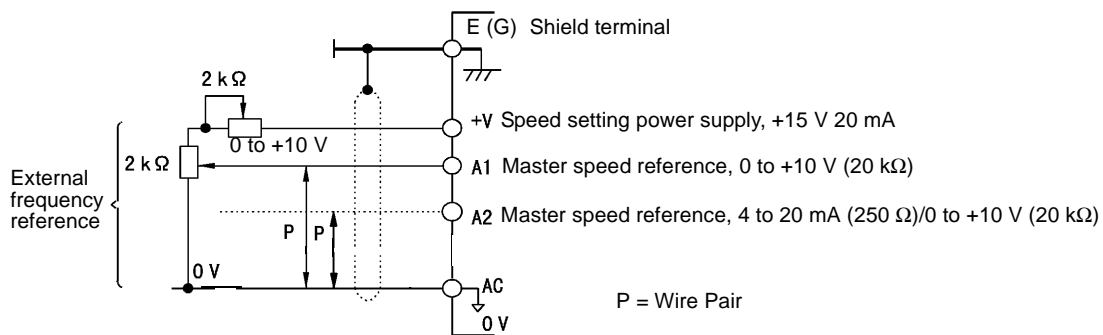

Fig 2.8 Analog Input Terminal Configuration on Drive

◆ Drive Terminal Block Configuration

The wiring terminals are shown in Figure 2.9.

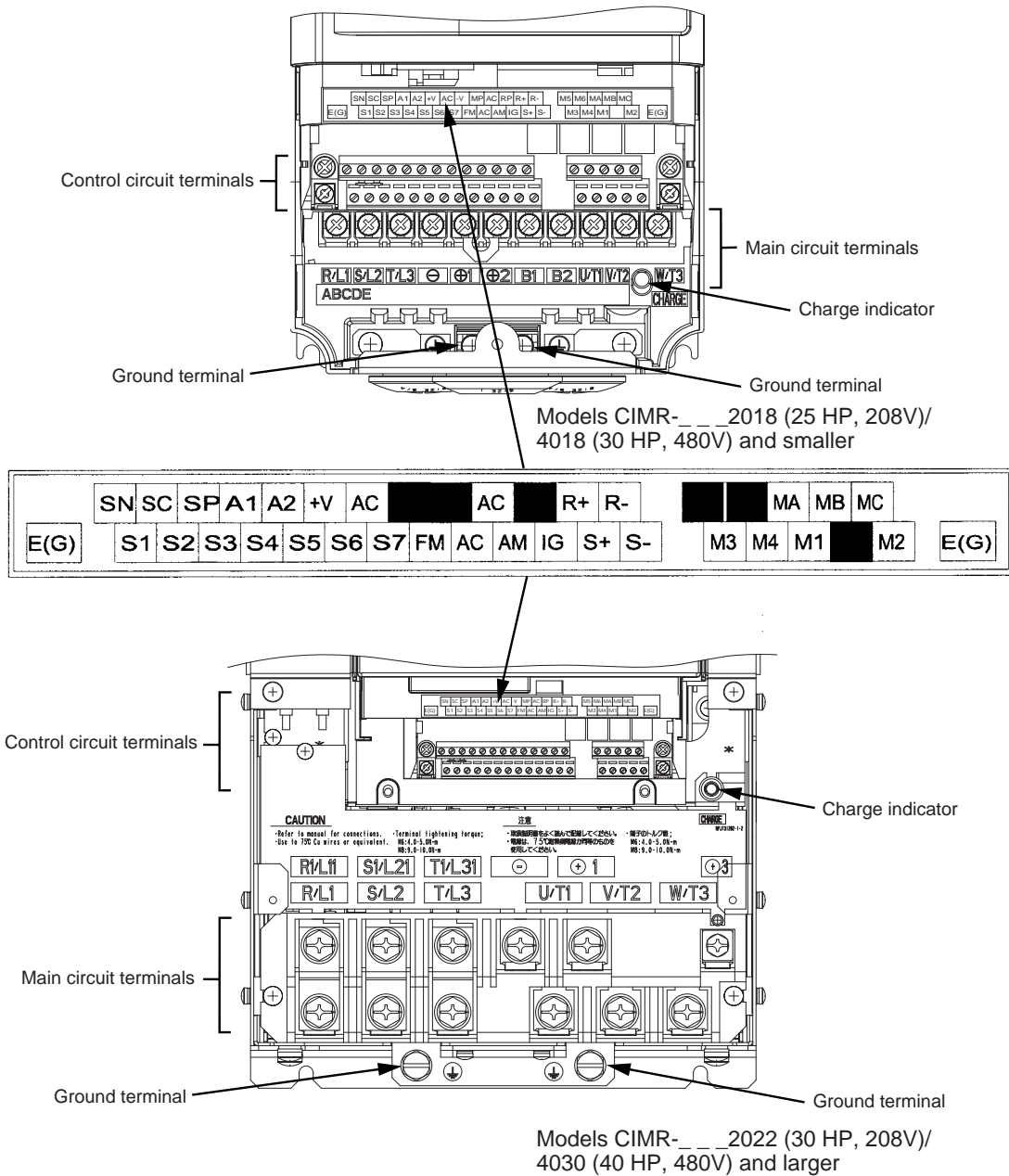

Fig 2.9 Drive Terminal Configuration

Table 2.5 Terminal Numbers and Wire Sizes (Same for all Bypass Units)					
Terminals	Terminal Screws	Tightening Torque lb.-in. (N•m)	Possible Wire Sizes AWG (mm ²)	Recommended Wire Size AWG (mm ²)	Wire Type
<p>DRIVE TERMINALS: FM, AC, AM, SC, SN, SP, A1, A2, +V, S1, S2, S3, S4, S5, S6, S7, MA, MB, MC, M1, M2, M3, M4, MP, R+, R-, S+, S-, IG</p> <p>TB1 ON PCB A2 TERMINALS: TB1-1 through TB1-26</p>	Phoenix type *3	4.2 to 5.3 (0.5 to 0.6)	Stranded wire: 26 to 16 (0.14 to 1.5)	18 (0.75)	<ul style="list-style-type: none"> • Shielded, twisted-pair wire *1 • Shielded, polyethylene-covered, vinyl sheath cable
E(G)	M3.5	7.0 to 8.8 (0.8 to 1.0)	20 to 14 (0.5 to 2*2)	12 (1.25)	

*1. Use shielded twisted-pair cables to input an external speed command.
*2. We recommend using straight solderless terminals on digital inputs to simplify wiring and improve reliability.
*3. We recommend using a thin-slot screwdriver with a 3.5 mm blade width.

◆ Wiring Checks

After all wiring is completed, perform the following checks:

1. Is all wiring correct?
2. Have all wire clippings, screws or other foreign material been removed from the Drive and Bypass enclosure?
3. Are all terminal screws tight?

◆ Control Circuit Wiring Precautions

Observe the following precautions when wiring control circuits:

1. Separate control wiring from power/motor wiring and other high-power lines.
2. Separate wiring for control circuit terminals for digital outputs from wiring to other control circuit terminals.
3. If using an optional external power supply, it should be a UL Listed Class 2 power supply source.
4. Use twisted-pair or shielded twisted-pair cables for control circuits to prevent operating faults. Prepare cable ends as shown in Figure 2.10.
5. Connect the shield wire to terminal E(G).
6. Insulate the shield with tape to prevent contact with other signal lines and equipment.

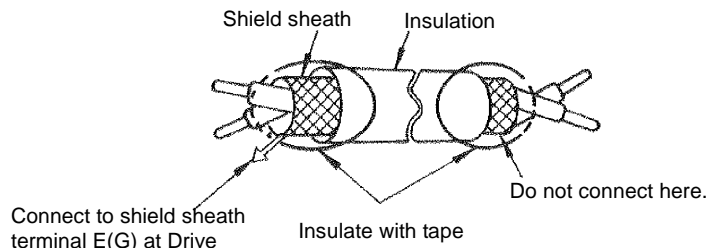

Fig 2.10 Preparing the Ends of Shielded Twisted-Pair Cables

◆ Bypass Control Circuit Terminal Functions

The functions of the control circuit terminals are shown in Table 2.6.

Type	No.	Signal Name	Function		Signal Level
Digital input signals	TB1-3	Auto Mode run/stop command	Run when CLOSED; stopped when OPEN.		Dry Contacts
	TB1-4				
	TB1-1	NC Safety Circuit	Fault when OPEN		
	TB1-2				
	TB1-5	Customer Supplied Interlock	Enable Drive when Closed		
	TB1-6				
	TB1-17	Smoke Purge	*Transfer to Bypass when Closed		
	TB1-18				
	TB1-23	2 Motor "OR"	*Transfer to Motor 2 When Closed		
	TB1-24				
	TB1-25	Remote Transfer	*Transfer to Bypass when Closed		
TB1-26					
Analog input signals (Drive)	+V	+15 VDC power output	+15 VDC power supply for analog Transmitters		+15 VDC (Max. current: 20 mA)
	A1	Analog Input or Speed Command	0 to +10 VDC/100%		0 to +10 V(20 kΩ)
	A2	Multi-function analog input	4 to 20 mA/100% 0 to +10 VDC/100% (H3-08)	Function set by H3-09.	4 to 20 mA(250Ω) 0 to +10 V(20kΩ)
	AC	Analog input common	-		-
	E(G)	Shield wire, optional ground line connection point	-		-
Digital output signals	TB1-7	Running on Drive	CLOSED During Operation		Dry contacts Contact capacity: 1 A max. at 250 VAC 1 A max. at 30 VDC
	TB1-8				
	TB1-9	Running on Bypass	11/12 CLOSED During Fault Condition 12/13 OPEN During Fault Condition		
	TB1-10				
	TB1-11	Drive Fault	14/15 CLOSED During Fault Condition 15/16 OPEN During Fault Condition		
	TB1-12				
	TB1-13				
	TB1-14	Motor Overload or Safety Circuit Fault	14/15 CLOSED During Fault Condition 15/16 OPEN During Fault Condition		
	TB1-15				
TB1-16					
Analog output signals (Drive)	FM	Multi-function analog output	Frequency Output 0 to +10 VDC/100% frequency	Multi-function analog monitor 1 Function set by H4-01	0 to +10 VDC max. ±5% 2 mA max.
	AC	Analog output common	-		
	AM	Multi-function analog output	Current Monitor 0 to +10 VAC/100% Drive's rated current	Multi-function analog monitor 2 Function set by H4-04	

* Switch Selectable Options

Type	No.	Signal Name	Function	Signal Level
RS-485/ 422 (Drive)	R+	Communication input	For 2-wire RS-485, short R+ to S+ and R- to S-.	Differential input, optical isolation
	R-			
	S+	Communication output		Differential input, optical isolation
	S-			
	IG	Signal common		-
Control Power Output	TB1-19	Damper Control	Pneumatic Control Interface	40VA@120V
	TB1-20			
	TB1-21	Customer Use	Power Customer control Devices	100VA@120V
	TB1-22			

◆ DIP Switch S1

DIP Switch S1 is described in this section. The functions of DIP switch S1 are shown in Table 2.7.

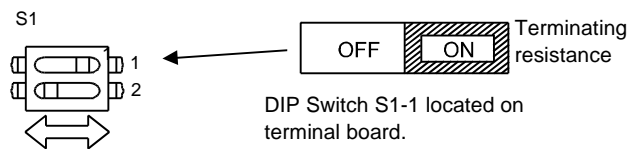
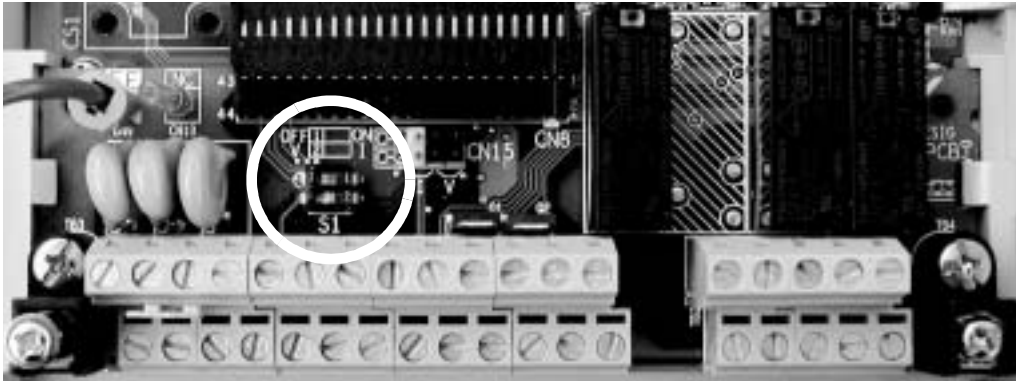

Fig 2.11 DIP Switch S1 Location

Name	Function	Setting
S1-1	RS-485 and RS-422 terminating resistance	OFF: No terminating resistance (Factory default) ON: Terminating resistance of 110Ω
S1-2	Input signal for analog input A2	OFF: 0-10 VDC (internal resistance: 20 KΩ) ON: 4-20 mA (internal resistance: 250 Ω) (Factory default)

◆ Shunt Connector CN15

The shunt connector CN15 is described in this section. Shunt connector along with parameters H4-07 and H4-08 select the signal range of the analog output terminals FM and AM.

Shunt connector CN15 is only available when the optional Terminal Card with the 4-20mA Analog Output Monitor is installed. See Chapter 7 for installation of the optional Terminal Card.

The function of various shunt connector CN15 configurations is shown in Table 2.8.

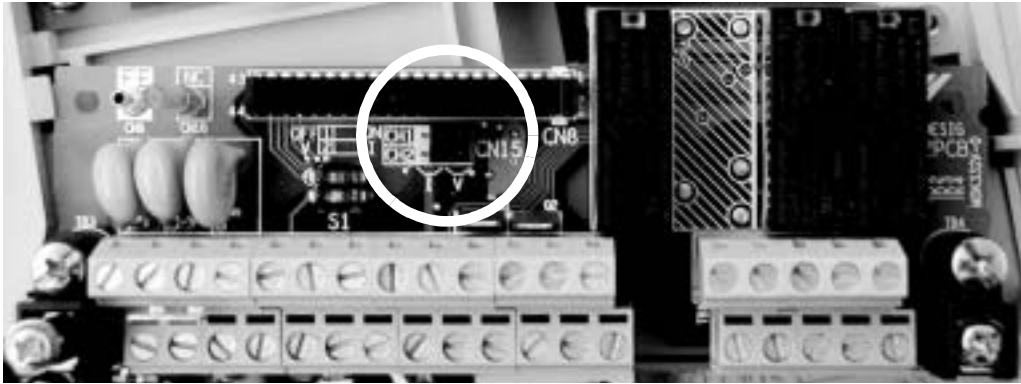

Fig 2.12 Shunt Connector CN15 Location

CN15	Analog Output Monitor Configurations
	Voltage Output (0-10 VDC) for terminals FM-AC (CH1) and AM-AC (CH2)
	Current Output (4-20mA) for terminals FM-AC (CH1) and AM-AC (CH2)
	Voltage Output (0-10 VDC) for terminals FM-AC (CH1) Current Output (4-20mA) for terminals AM-AC (CH2)
	Current Output (4-20mA) for terminals FM-AC (CH1) Voltage Output (0-10 VDC) for terminals AM-AC (CH2)

The software configuration for the analog output monitor signal type is listed below:

Parameter No.	Parameter Name Digital Operator Display	Description	Setting Range	Factory Setting	Menu Location
H4-07	Terminal FM Signal Level Selection AO Level Select1	0: 0 - 10 V 2: 4-20 mA	0 or 2	0	Programming
H4-08	Terminal AM Signal Level Selection AO Level Select2	0: 0 - 10 V 2: 4-20 mA	0 or 2	0	Programming

◆ Field Wiring Diagram

Use these diagrams to document your field wiring. We suggest copying this page based on your installation needs.

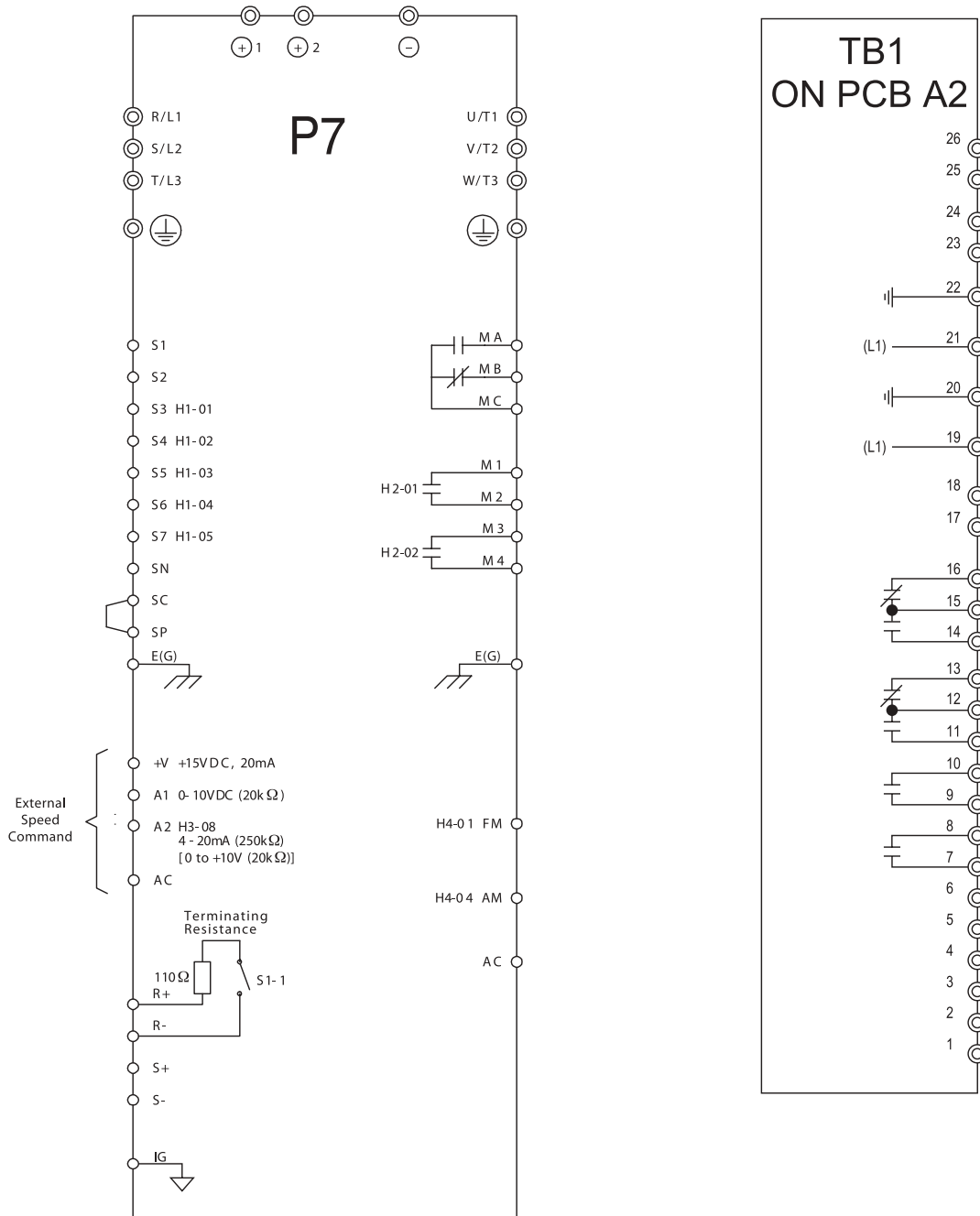
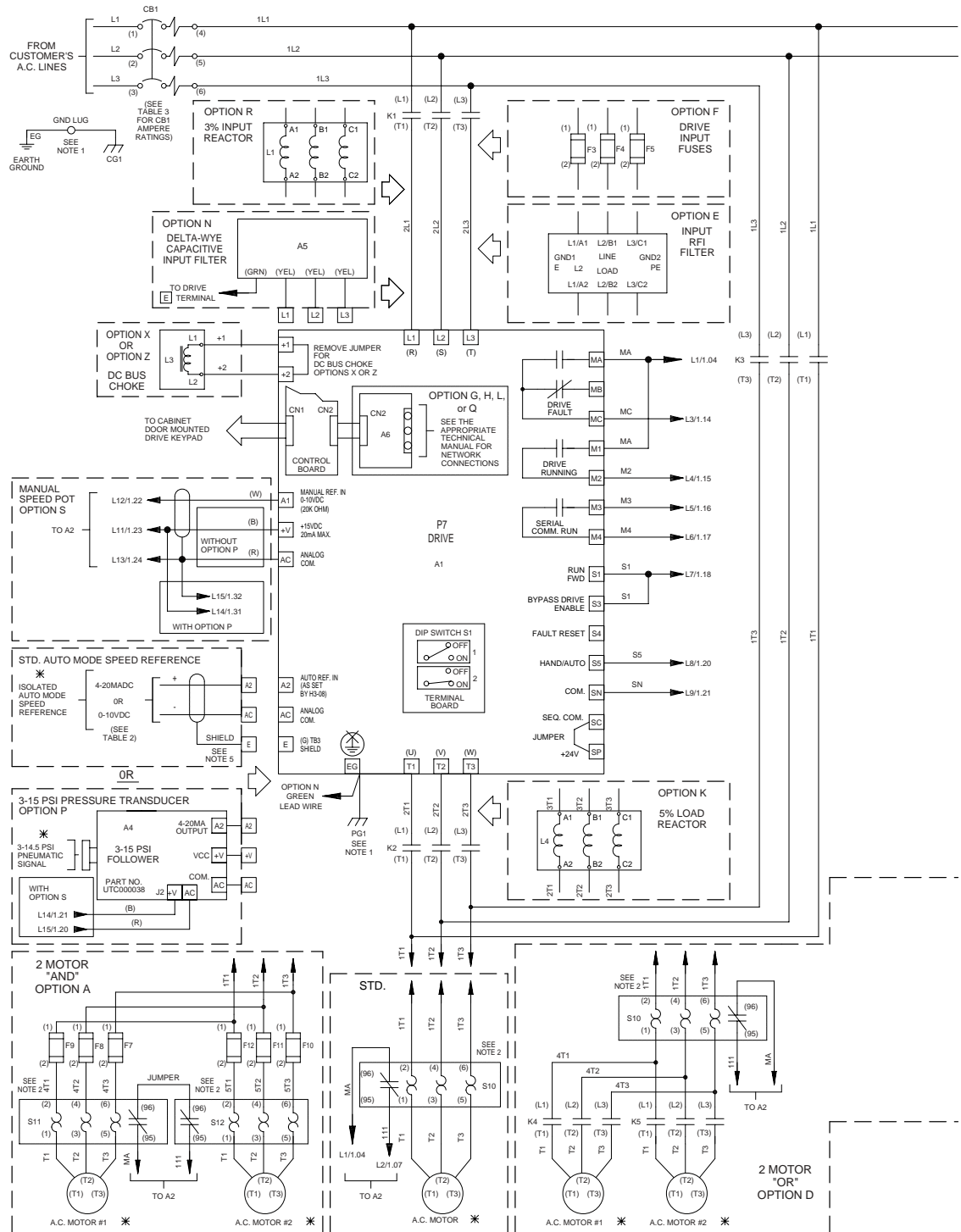
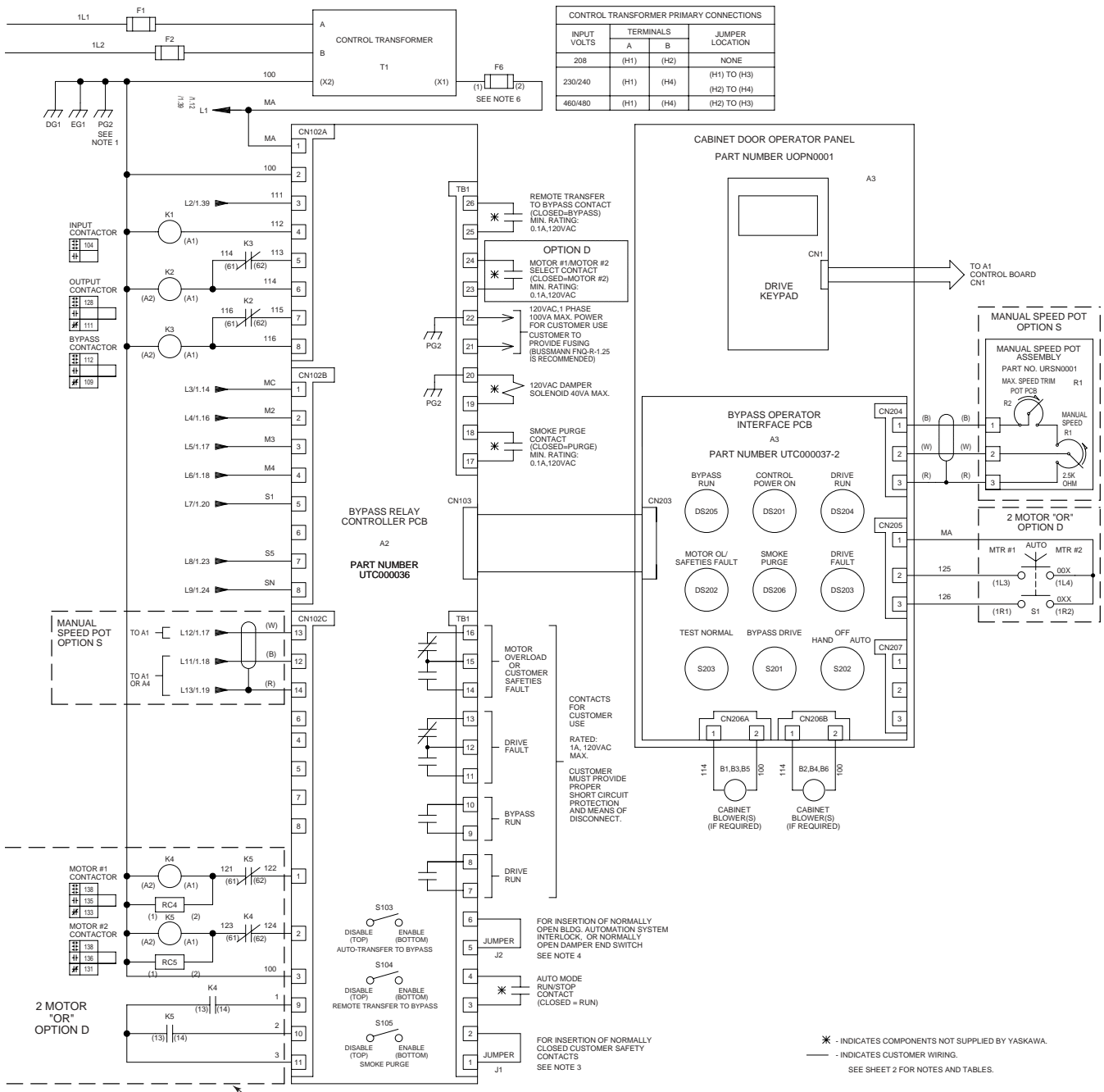

Fig 2.13 Field Wiring Diagram

Notes:

Wiring Diagram





Items within dashed line boxes are optional equipment

Logic Diagram

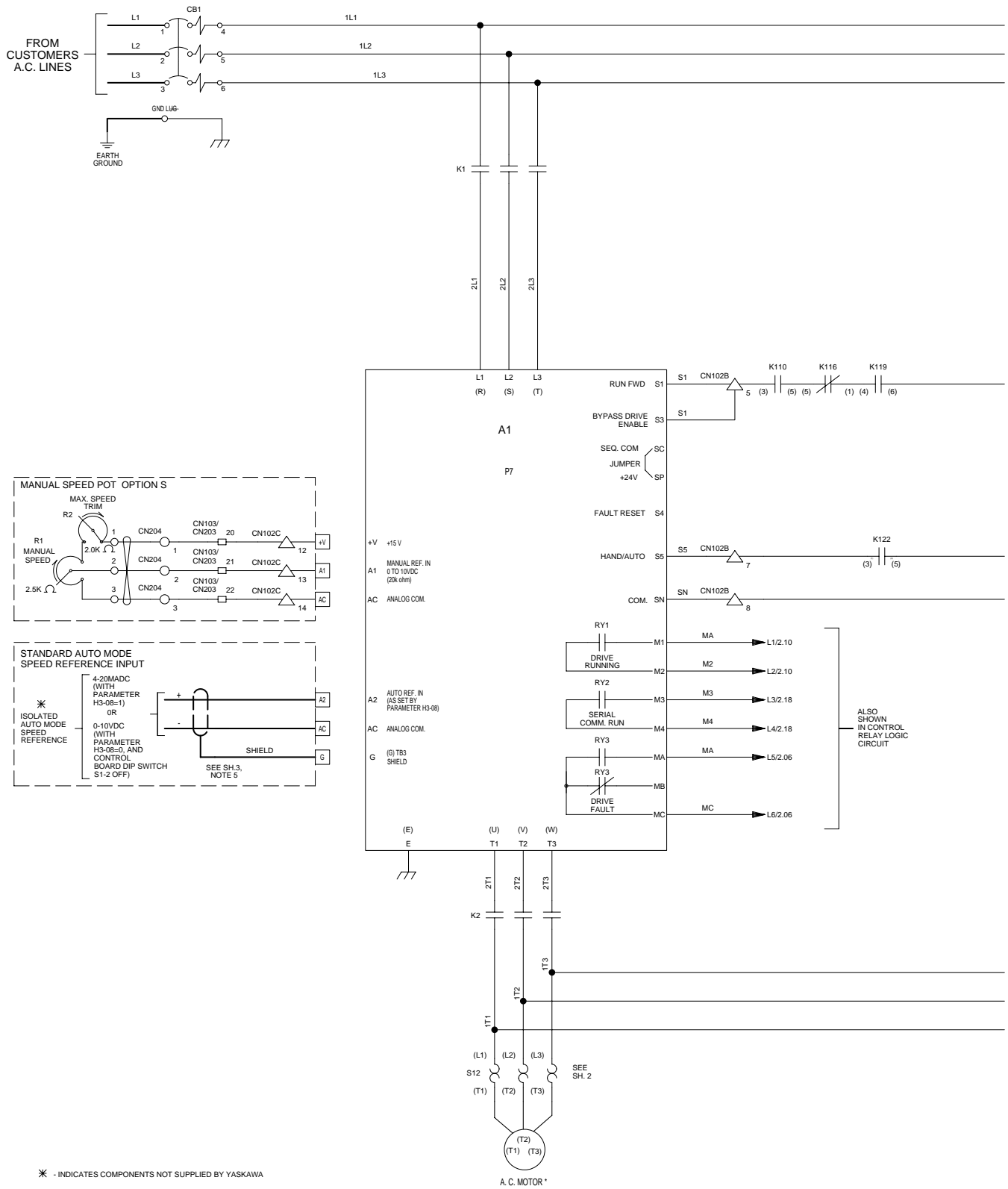

* - INDICATES COMPONENTS NOT SUPPLIED BY YASKAWA

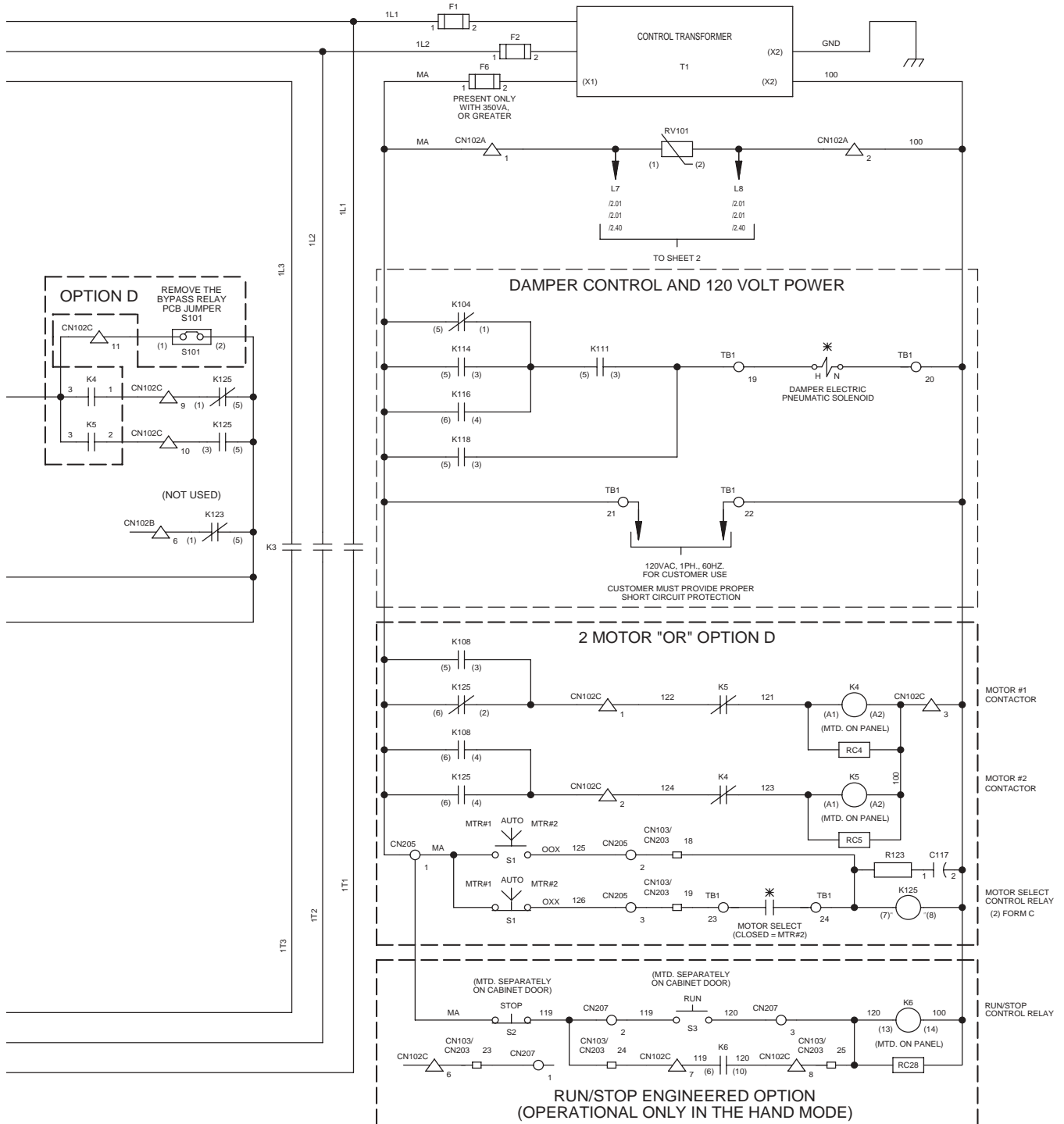

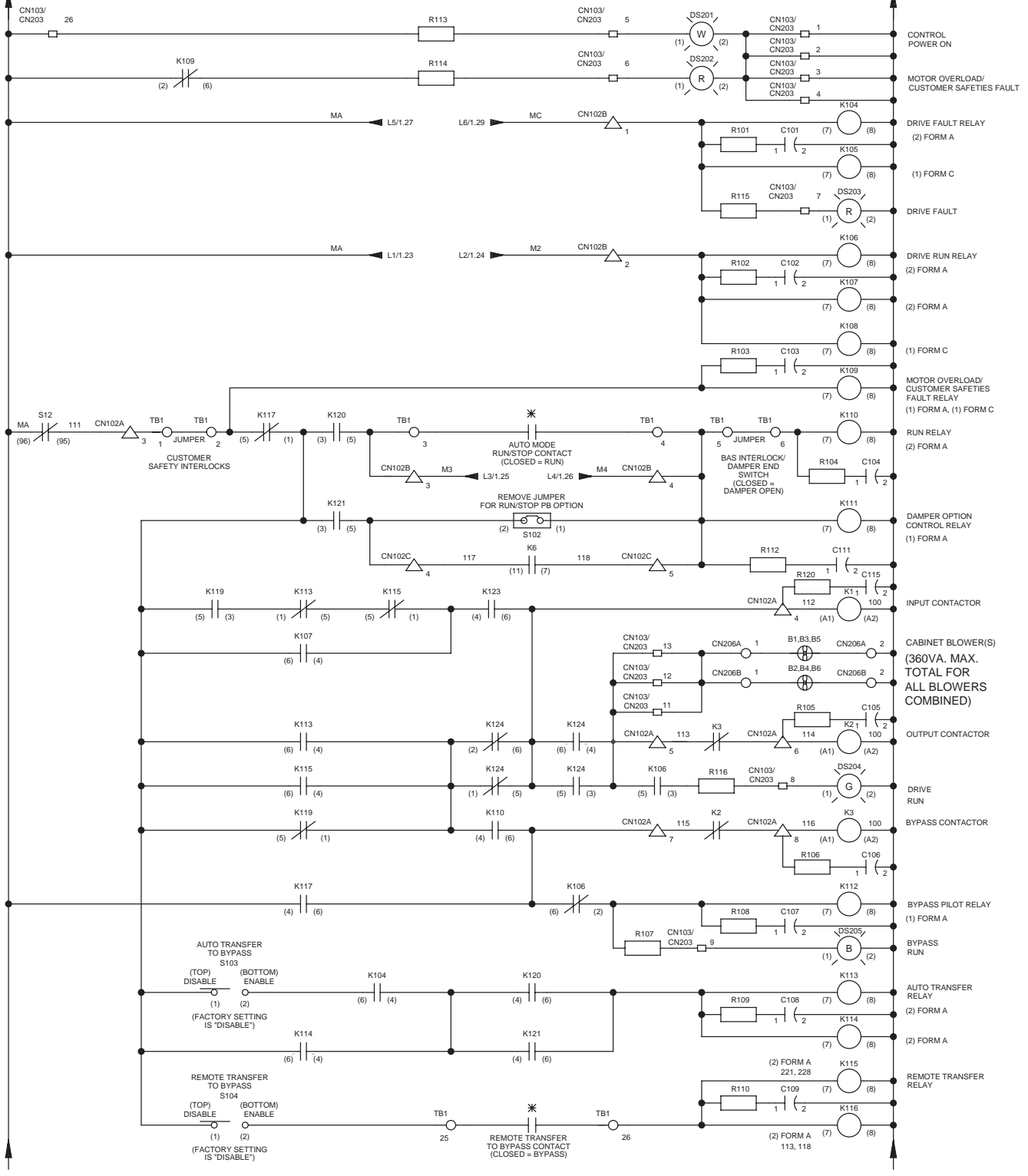

L7/1.06

LB/1.06

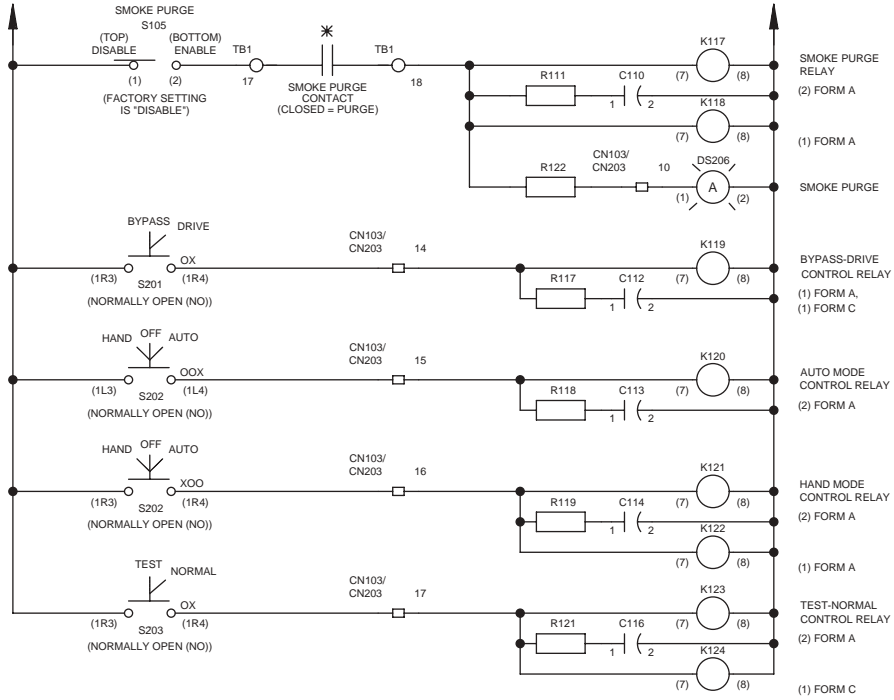

BYPASS RELAY PCB UTC000036 CONNECTORS

- TB1 - XX - CUSTOMER CONNECTION POINT ON 26 POINT, 1 PIECE PHOENIX CONNECTOR. TORQUE WIRE CONNECTIONS TO 4.4 POUND-INCH.
- CN102A - XX - 8 POINT MOLEX HEADER. USED TO CONNECT THE PANEL HARNESS TO THE BYPASS RELAY PCB.
- CN102B - XX - 8 POINT MOLEX HEADER. USED TO CONNECT THE PANEL HARNESS TO THE BYPASS RELAY PCB.
- CN102C - XX - 14 POINT, 1 PIECE PHOENIX CONNECTOR. USED TO CONNECT PANEL MOUNTED OPTIONS TO THE BYPASS RELAY PCB.
- CN103 - XX - 26 POINT RIBBON CABLE HEADER. USED TO CONNECT TO THE CABINET DOOR MOUNTED OPERATOR PCB CONNECTOR CN203.

OPERATOR PCB UTC000037-2 CONNECTORS

- CN203 - XY - 26 POINT RIBBON CABLE HEADER. USED TO CONNECT TO THE BYPASS RELAY PCB CONNECTOR CN103.
- CN204 - X - 3 POINT, 2 PIECE PHOENIX CONNECTOR. USED TO CONNECT THE OPTIONAL CABINET DOOR MOUNTED MANUAL SPEED POT TO THE OPERATOR PCB/PANEL.
- CN205 - X - 3 POINT, 2 PIECE PHOENIX CONNECTOR. USED TO CONNECT THE OPTIONAL CABINET DOOR MOUNTED 2 MOTOR "OR" SELECTOR SWITCH TO THE OPERATOR PCB/PANEL.
- CN206A - X - 2 POINT, 2 PIECE PHOENIX CONNECTOR. USED TO CONNECT THE OPTIONAL CABINET DOOR MOUNTED BLOWER(S) TO THE OPERATOR PCB/PANEL.
- CN206B - X - 2 POINT, 2 PIECE PHOENIX CONNECTOR. USED TO CONNECT THE OPTIONAL CABINET DOOR MOUNTED BLOWER(S) TO THE OPERATOR PCB/PANEL.
- CN207 - X - 3 POINT, 2 PIECE PHOENIX CONNECTOR. USED TO CONNECT THE OPTIONAL CABINET DOOR MOUNTED PARTS (AND THE "HAND" MODE RUN AND STOP PUSHBUTTONS) TO THE OPERATOR PCB/PANEL.

RUN AND FAULT CONTACT ANNUNCIATION

RATED: 1AMP, 120VAC MAX.

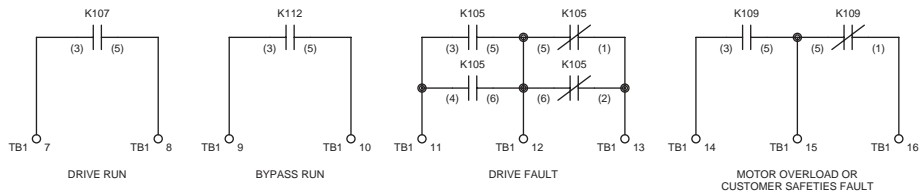

Notes:

Chapter 3

Control Panel

This chapter describes the displays and functions of the Control Panel.

Digital Operator and Control Panel Display	2
Digital Operator Keys	3
Drive Mode Indicators	4
Control Panel Indicator Lights	5
Drive Main Menus	8
Main Menu Structure	9
DRIVE - Operation Menu	10
QUICK - Quick Setting Menu	13
ADV- Programming Menu	14
VERIFY - Modified Constants (Parameters) Menu	15
A.TUNE - Auto-Tuning Menu	15
Example of Changing a Parameter	16

Digital Operator and Control Panel Display

The various items included on the Digital Operator Display and Control Panel are described below.

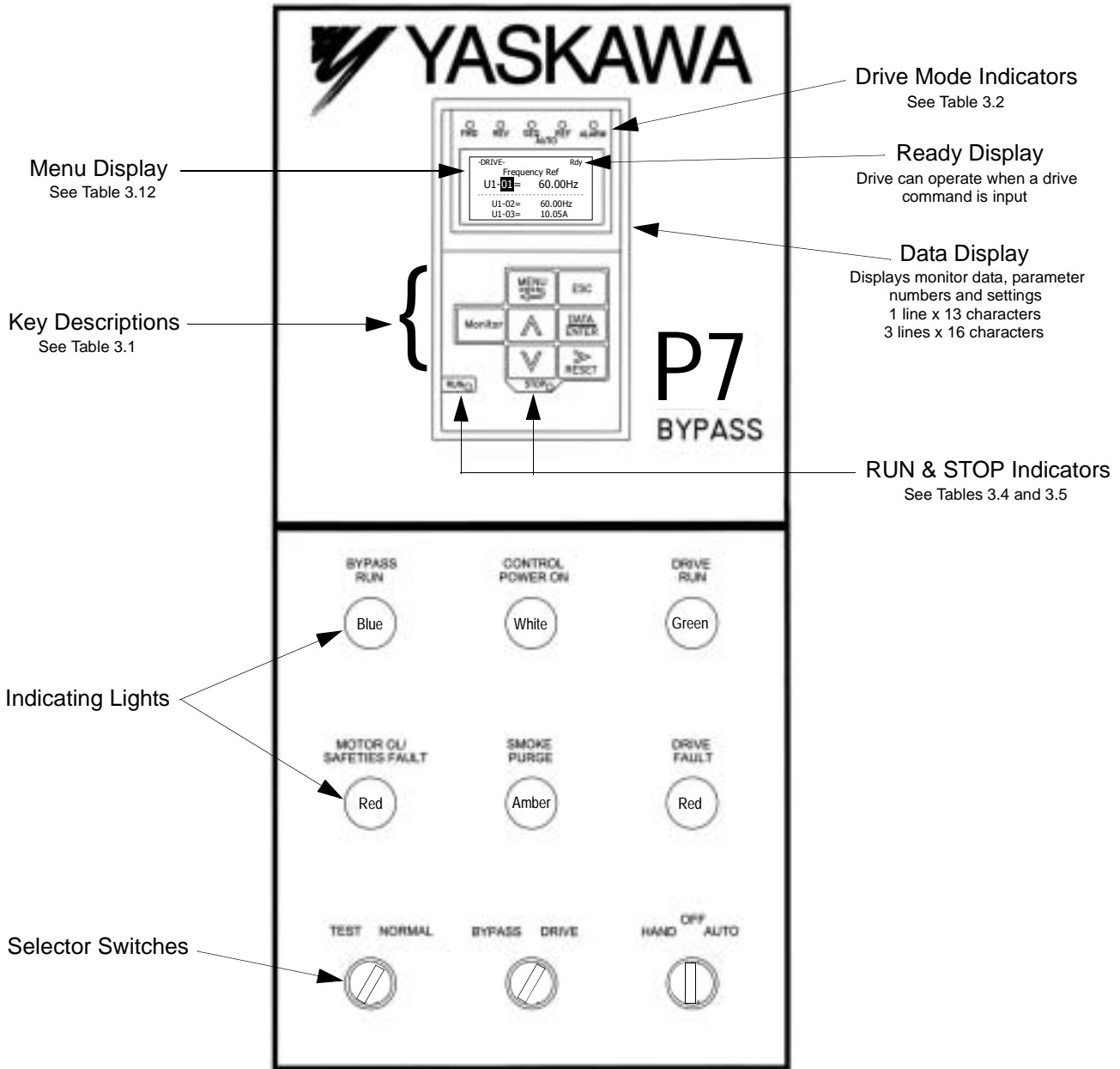





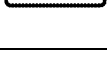

Fig 3.1 P7 Bypass Control Panel Component Names and Functions

◆ Digital Operator Keys

The names and functions of the Digital Operator Keys are described in Table 3.1.

Table 3.1 Digital Operator Keys		
Key	Name	Function
	MENU Key	Scrolls from one of the five main menus to the next.
	ESCAPE Key	Returns to the display before the DATA/ENTER key was pressed.
	MONITOR Key	Selects the monitor (-DRIVE-) mode from any display location.
	INCREASE Key	Increases parameter numbers and set values. Used to move to the next item or data.
	DECREASE Key	Decreases parameter numbers and set values. Used to move to the previous item or data.
	SHIFT/RESET Key	Selects the digit to be changed. The selected digit will blink. Also resets the Drive when a fault has occurred.
	DATA/ENTER Key	Pressed to enter menus and parameters as well as to set values.

◆ Drive Mode Indicators

The definition of the Drive mode indicators are shown in Table 3.2.

Indicator	Definition
FWD	Lit when a forward run command is input. Also lit when the Drive is in “Hand” Mode.
REV	Lit when a reverse run command is input.
AUTO SEQ	Lit when set up for remote run command, see Table 3.3.
AUTO REF	Lit when set up for remote speed command, see Table 3.3.
ALARM	Lit when a fault has occurred and flashing when an alarm has occurred.

■ Drive AUTO Sequence (SEQ) and AUTO Reference (REF) indicators

The Bypass operates differently than a stand alone Drive with regard to these two indicators. The Bypass control logic interfaces with the Drive via terminals that would be used, in a Drive only installation, for the AUTO Sequence (Run Command), and AUTO Reference (Speed Command).

Since these terminals are active and the appropriate parameters configured for the Bypass unit operation (see Tables 5.1 and 5.2), the AUTO Sequence and AUTO Reference LED’s will be lit even when the H/O/A is in HAND position (local control), providing both the run and speed command from the local control panel. The control signals are “Local” to the Drive and Bypass unit, but “Remote” (AUTO) from the Drive itself.

Hand Mode	Auto Mode
On	On

■ Drive Run Indicator

The status of the “RUN” indicator is shown in Table 3.4 when the Drive is either in the “Hand” or “Auto” mode.

Table 3.4 RUN Indicator	
Indicator Status	Description
On	Drive is running
Blinking	Drive is decelerating to a stop
Off	Drive is stopped

■ Drive Stop Indicator

The status of the “STOP” indicator is shown in Table 3.5 when the Drive is either in the “Hand” or “Auto” mode.

Table 3.5 STOP Indicator	
Indicator Status	Description
On	Drive is decelerating to a stop or stopped
Blinking	Drive is in a run condition but the speed command is zero
Off	Drive is running

◆ Control Panel Indicator Lights

■ Control Power Indicator

Table 3.6 Control Power Indicator	
Indicator Status	Condition
On	3 Phase Power is applied to the Bypass unit and the control power transformer is functioning.
Off	3 Phase Power is disconnected from the Bypass unit or a control power transformer fuse has cleared.

■ Drive Run Indicator

Table 3.7 Drive Run Indicator	
Indicator Status	Condition
On	The Drive has been given a run command in hand or auto mode and the Bypass circuit is de-energized.
Off	The Drive has no run command in either the hand or auto modes. The unit may be operating in Bypass mode.

■ Bypass Run Indicator

Table 3.8 Bypass Run Indicator	
Indicator Status	Description
On	<p>The Bypass has been given a run command in the HAND or AUTO mode.</p> <p>Or, the operation has been remotely transferred to Bypass using the switch selectable “Remote Transfer to Bypass” feature (S104) via a customer supplied contact closure at terminals TB1-25 and TB1-26.</p> <p>Or, the operation has been automatically transferred to Bypass after a Drive fault condition via the switch selectable “Auto Transfer to Bypass” feature (S103).</p> <p>Or, the operation has been transferred to Bypass using the switch-selectable “Smoke Purge” feature (S105) via a contact closure at terminals TB1-17 and TB1-18.</p> <p>The motor is running at full speed across-the-line and the Drive is de-energized.</p>
Off	<p>The Bypass has no run command in either the HAND or AUTO modes. The unit may be operating in Drive mode.</p>

■ Motor OL/Safeties Fault Indicator

Table 3.9 Motor OL/Safeties Fault Indicator	
Indicator Status	Description
On	<p>The motor overload (S10) has tripped OFF de-energizing both the Drive and Bypass Circuits.</p> <p>Or, the NC “motor safety circuit” connected to terminals TB1-1 and TB1-2 has an open circuit condition.</p>
Off	<p>The motor overload (S10) and NC “motor safety circuit” are satisfied.</p>

■ Drive Fault Indicator

Table 3.10 Drive Fault Indicator	
Indicator Status	Description
On	The Drive has tripped OFF due to an internal Drive fault.
Off	The Drive is ready for operation, or operating normally.

■ Smoke Purge Indicator

Table 3.11 Smoke Purge Indicator	
Indicator Status	Description
On	The Smoke Purge function has been selected by closing switch S105 on PCB A2 and the building fire control system has closed a contact between terminals TB1-17 and TB1-18.
Off	Smoke Purge is not active, the Drive & Bypass are operating normally.

Drive Main Menus

The Drive's parameters and monitoring functions are organized into groups called menus that make it easier to read and set parameters. The Drive is equipped with five menus. The five menus and their primary functions are shown in Table 3.12 and are directly available by pressing the **MENU** key.

Main Menu	Primary Function(s)
- DRIVE - Operation	The Drive can be run in this menu. Also called the "Monitor" menu. Use this menu for monitoring values such as frequency reference or output current, displaying fault history or displaying the fault traces.
- QUICK - Quick Setting	The Drive can be programmed in this menu. Use this menu to set/read the most commonly used parameters.
- ADV - Programming	The Drive can be programmed in this menu. Use this menu to set/read every parameter.
- VERIFY - Modified Constants (Parameters)	The Drive can be programmed in this menu. Use this menu to set/read the parameters that have been modified from their factory default settings.
- A.TUNE - Auto-Tuning	For Bypass units Auto-Tuning can only be accomplished through the DriveWizard software. A free download from www.drives.com . The Drive can be programmed in this menu. Use this menu to auto-tune the Drive in order to utilize the bi-directional speed search feature.

◆ Main Menu Structure

The menu selection display will appear when the MENU key is pressed from a monitor or setting display. While viewing the menu selection display, press the MENU key repeatedly to scroll between the menu selections.

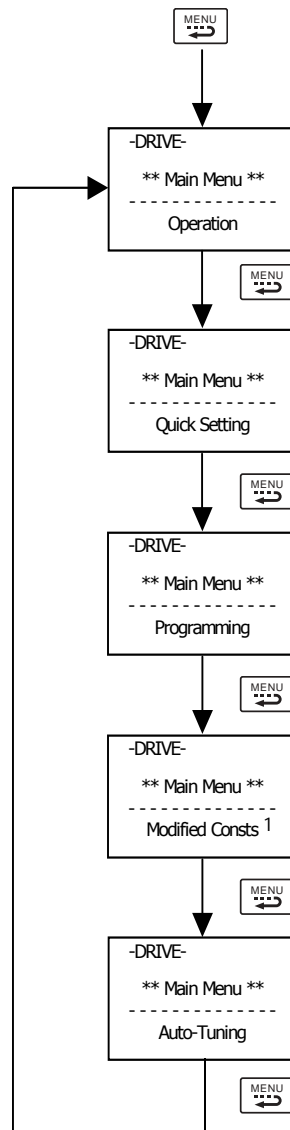

Press the DATA/ENTER key to enter the desired menu selection.

¹ Modified Consts = Modified Parameters



◆ - DRIVE - Operation Menu

This menu is used for setting a speed command or monitoring values such as output frequency and output current. It is also used for displaying the fault history and the fault traces. *The Drive may be limited to this menu in order to accept a run command, see parameter b1-08 in Chapter 5 and Table 5.1.*

■ U1 Monitor Parameter List

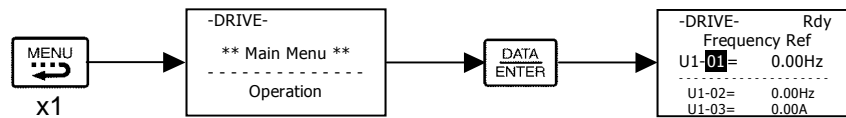
Follow the key operations below to access the Operation Menu.





Use  and  keys to scroll through the U1 “Monitor” parameter list.

Monitor Parameters	
U1-01	Frequency Ref
U1-02	Output Freq
U1-03	Output Current
U1-06	Output Voltage
U1-07	DC Bus Voltage
U1-08	Output kWatts
U1-10	Input Term Sts
U1-11	Output Term Sts
U1-12	Int Ctl Sts 1
U1-13	Elapsed Time
U1-14	FLASH ID
U1-15	Term A1 Level
U1-16	Term A2 Level
U1-18	Mot SEC Current
U1-20	SFS Output
U1-24	PI Feedback
U1-28	CPU ID
U1-29	kWh
U1-30	MWh
U1-34	OPE Detected
U1-36	PI Input
U1-37	PI Output
U1-38	PI Setpoint
U1-39	Transmit Err
U1-40	FAN Elapsed Time
U1-51	Auto Mode Fref
U1-52	Hand Mode Fref
U1-53	PI Feedback 2

■ U2 Fault Trace Parameter List

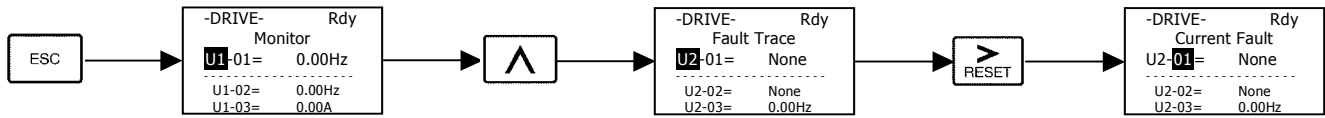
After viewing the “Monitor” parameter list, in order to view the “Fault Trace” parameter list, follow the example below.





Use  and  keys to scroll through the U2 “Fault Trace” parameter list.

Fault Trace Parameters	
U2-01	Current Fault
U2-02	Last Fault
U2-03	Frequency Ref
U2-04	Output Freq
U2-05	Output Current
U2-07	Output Voltage
U2-08	DC Bus Voltage
U2-09	Output kWatts
U2-11	Input Term Sts
U2-12	Output Term Sts
U2-13	AC Drive Status
U2-14	Elapsed Time

■ U3 Fault History Parameter List

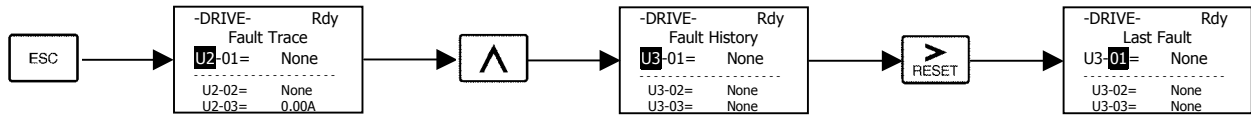
After viewing the “Fault Trace” parameter list, in order to view the “Fault History” parameter list, follow the example below.





Use  and  keys to scroll through the U3 “Fault History” parameter list.

Fault History Parameters	
U3-01	Last Fault
U3-02	Fault Message 2
U3-03	Fault Message 3
U3-04	Fault Message 4
U3-05	Elapsed Time 1
U3-06	Elapsed Time 2
U3-07	Elapsed Time 3
U3-08	Elapsed Time 4
U3-09	Fault Message 5
U3-10	Fault Message 6
U3-11	Fault Message 7
U3-12	Fault Message 8
U3-13	Fault Message 9
U3-14	Fault Message 10
U3-15	Elapsed Time 5
U3-16	Elapsed Time 6
U3-17	Elapsed Time 7
U3-18	Elapsed Time 8
U3-19	Elapsed Time 9
U3-20	Elapsed Time 10

◆ - QUICK - Quick Setting Menu

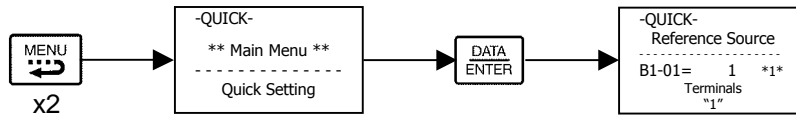
This menu is used to set/read a limited set of parameters in the Drive. Follow the key operations below to access the Quick Setting Menu.







Use  and  keys to scroll through the “Quick Setting” parameter list.

Parameter Number	Parameter Name
A1-00	Language Selection
b1-01	Frequency Reference Selection
b1-02	Run command Selection
b1-03	Stopping Method Selection
b1-04	Reverse Operation Selection
b5-XX	PI Mode Parameters
b8-01	Energy Savings Control Selection
C1-01	Acceleration Time 1
C1-02	Deceleration Time 1
d2-01	Frequency Reference Upper Limit
d2-02	Frequency Reference Lower Limit
E1-01	Input Voltage Setting
E2-01	Motor Rated Current
F6-01	Operation Selection After Communication Error
H3-02	Terminal A1 Gain Setting
H3-03	Terminal A1 Bias Setting
H3-10	Terminal A2 Gain Setting
H3-11	Terminal A2 Bias Setting
L2-01	Momentary Power Loss Detection Selection
L2-02	Momentary Power Loss Ride-thru Time
L4-05	Frequency Reference Loss Detection Selection
L4-06	Frequency Reference Level at Loss Frequency
L5-01	Number of Auto Restarts Attempts
L5-03	Maximum Restart Time After Fault
L6-01	Torque Detection Selection 1
L6-02	Torque Detection Level 1
L6-03	Torque Detection Time 1
L8-11	Heatsink Cooling Fan Operation Delay Time
o1-01	User Monitor Selection
o1-05	LCD Brightness Adjustment
o1-07	Second Line User Monitor Selection
o1-08	Third Line User Monitor Selection
o2-03	User Parameter Default Value
o2-05	Frequency Operation Time Selection
o2-08	Cumulative Operation Time Selection
o3-02	Read Allowed Selection

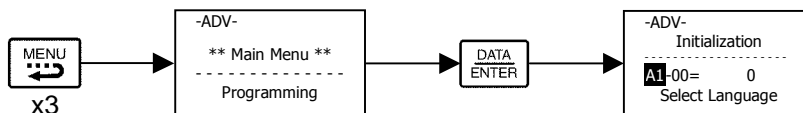
◆ - ADV- Programming Menu

This menu is used to set/read every parameter in the Drive. Follow the key operations below to access the Programming Menu.



Use , , and  keys to scroll through the “Programming” parameter group list. For a complete parameter list see Appendix A.

Parameter Group Functions	
A1	Initialization
A2	User Parameters
b1	Sequence
b2	DC Braking
b3	Speed Search
b4	Delay Timers
b5	PI Control
b8	Energy Saving
C1	Accel/Decel
C2	S-Curve Acc/Dec
C4	Torque Comp
C6	Carrier Freq
d1	Preset Reference
d2	Reference Limits
d3	Jump Frequencies
d4	Sequence
d6	Field-Weakening
E1	V/F Pattern
E2	Motor Setup
F6	Com OPT Setup
H1	Digital Inputs
H2	Digital Outputs
H3	Analog Inputs
H4	Analog Outputs
H5	Serial Com Setup
L1	Motor Overload
L2	PwrLoss Ridethru
L3	Stall Prevention
L4	Ref Detection
L5	Fault Restart
L6	Torque Detection
L8	Hdwe Protection
n1	Hunting Prev
n3	High Slip
o1	Monitor Select
o2	Key Selections
o3	COPY Function

◆ - VERIFY - Modified Constants (Parameters) Menu

This menu is used to set/read only those parameters that have been modified from the Drive's original factory default settings. Follow the key operations below to access the Modified Constants (Parameters) Menu.

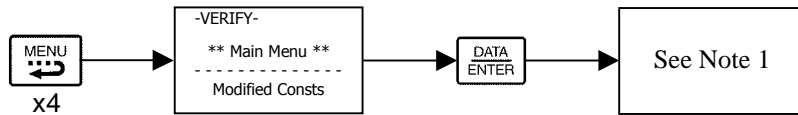



Note 1: If there are not any parameters that have been modified from their original factory default settings, then the display will state “None Modified”. Otherwise, use the “increase” and “decrease” keys to scroll through the “Modified Constants” (Parameters) list.

◆ - A.TUNE - Auto-Tuning Menu

For P7 Bypass units Auto-Tuning can only be accomplished through the DriveWizard software. A free download from www.drives.com.

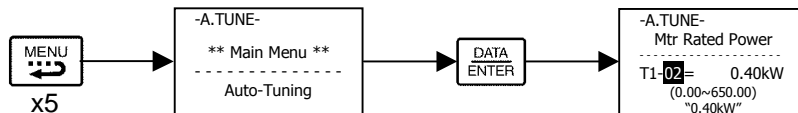
This menu is used to auto-tune the Drive in order to utilize the bi-directional speed search feature. Follow the key operations below to access the Auto-Tuning Menu.



Use  and  keys to scroll through the “Auto-Tuning” parameter list.

Auto-Tuning Parameters	
T1-02	Mtr Rated Power
T1-04	Rated Current

Example of Changing a Parameter

Table 3.13 provides an example of how to change parameter “C1-02” (Deceleration Time 1) from 30 sec to 40 sec.

Table 3.13 Changing a Parameter in the Programming Menu		
Step Number	Digital Operator Display	Description
1	<pre> -DRIVE- Rdy Frequency Ref U1-01= 0.00Hz ----- U1-02= 0.00Hz U1-03= 0.00A </pre>	The Drive is first powered up.
2	<pre> -DRIVE- ** Main Menu ** ----- Operation </pre>	Press the MENU key to scroll to “Operation” menu.
3	<pre> -QUICK- ** Main Menu ** ----- Quick Setting </pre>	Press the MENU key to scroll to “Quick Setting” menu.
4	<pre> -ADV- ** Main Menu ** ----- Programming </pre>	Press the MENU key to scroll to “Programming” menu.
5	<pre> -ADV- Initialization ----- A1-01= 0 Select Language </pre>	Press the DATA/ENTER key to enter “Programming” menu.
6	<pre> -ADV- Accel/Decel ----- C1-01= 1.0sec Accel Time 1 </pre>	Press the INCREASE key until C1-01 (Accel/Decel) is displayed.
7	<pre> -ADV- Accel Time 1 ----- C1-01= 30.0sec (0.0~6000.0) "30.0sec" </pre>	Press the SHIFT/RESET key to move flashing digit to the right.

Table 3.13 Changing a Parameter in the Programming Menu (Continued)

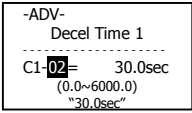
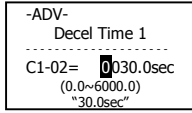
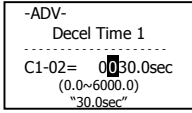
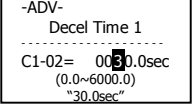
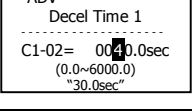
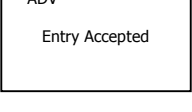
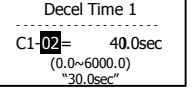
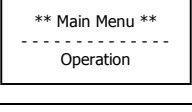
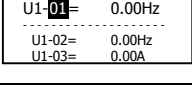
Step Number	Digital Operator Display	Description
8		Press the INCREASE key to display C1-02 (Decel Time 1).
9		Press the DATA/ENTER key to access setting display.
10		Press the SHIFT/RESET key to move the flashing digit to the right.
11		Press the SHIFT/RESET key to move the flashing digit to the right.
12		Press the INCREASE key to increase the set data.
13		Press the DATA/ENTER key to enter the set data. "Entry Accepted" is displayed for 1.0 sec after the data setting has been confirmed.
14		The monitor display for C1-02 returns.
15		Press the MENU key to scroll to "Operation" menu.
16		Press the DATA/ENTER key to enter "Operation" menu.

Notes:

Chapter 4

Start Up and Operation

This chapter describes the procedures to prepare for and conduct the P7B Drive and Bypass unit start up.

Start Up Introduction	2
Bypass Start Up Preparation	3
Bypass Unit Start Up Procedure	4
Bypass Operation Description.....	8
Selector Switch Functions	9
Switch Selectable Functions	10
Contact Closure Inputs and Outputs	10

Start Up Introduction

In order to provide you with the most reliable Drive and Bypass unit available, and to avoid any extra costs related to loss or reduction of warranty coverage, an authorized Yaskawa service representative should complete this start up procedure. Please complete the checklist in this document and maintain it in a secured location. Should you have a need to contact Yaskawa in the future, technical service personnel may request information from this document.



Procedures within this document assume that start up is being accomplished by a Yaskawa authorized service person who has training on the product and is capable of working through the detailed steps with power applied to the Bypass unit while the enclosure door is open.

BYPASS START UP PREPARATION

- 1. Review this Bypass Technical Manual and any option instructions and schematics shipped with the Drive and Bypass unit.
- 2. Verify that the model numbers and voltage ratings are as specified in the purchase order by matching the nameplate data for each unit to the purchase order.
- 3. Verify that the unit has been installed in accordance with Chapter 1, *Receiving and Mechanical Installation* and Chapter 2, *Electrical Installation*.
- 4. Inspect the security of the supply line power, ground connections and all control circuit connections as identified in Chapter 2, *Electrical Installation*.

Double check all the power wires and motor wires.

Verify that the electrical supply power lines are connected to the input circuit breaker and that the motor leads are connected to the output terminals of the overload relay. Ensure that all connections are tight, loose wire connections may cause intermittent problems or overheating. Factory connections sometimes come loose during shipment.

- 5. Review the installer's "as wired" schematic. Determine if a driven motor "safety circuit" is connected. This is a series circuit of NC contacts from devices such as a smoke/fire sensor, freeze-up thermostat or high static pressure limit switch. Verify that these customer emergency contacts are properly terminated in the Bypass safety shutdown circuit. These contacts should be wired between terminal **TB1-1** and **TB1-2**. No field programming is required.

Verify that all other field installed wires are correctly terminated (included the shields).

- 6. Verify that the motor is wired for the application voltage. Record the motor nameplate information:

Voltage _____ Full Load Amps (FLA) _____
(or Rated Load Amps (RLA))

- 7. Verify that the input voltage matches the Bypass unit rating.
- 8. Verify that the motor rated full load amps (FLA) does not exceed the rated output current of the Drive and Bypass controlling it. When multiple motors are simultaneously operated by the Drive, the sum of all motor FLA values must be less than or equal to that of the Drive and Bypass controlling them.
- 9. Record any other connections to the Bypass unit, by terminal number to determine if special programming of any of the following is required. (see Chapter 5 for programming details).
 - Multi-function Digital Inputs
 - Multi-function Digital Outputs
 - Analog Outputs
 - Differential PI control
- 10. Verify that the customer supplied logic is ready for the start, stop and speed command functions.

BYPASS UNIT START UP PROCEDURE

(Please review “Bypass Start Up Preparation” on page 4-3)

- 1. Before applying power, make sure that the following conditions are met:
 - The **DRIVE/BYPASS** switch is in the **DRIVE** position.
 - The **HAND/OFF/AUTO** switch is in the **OFF** position.
 - The **NORMAL/TEST** switch is in the **NORMAL** position. [Note: If the **TEST** position is selected while the **DRIVE/BYPASS** switch is in the **DRIVE** position, the fault code “UV, DC Bus Undervolt” will be briefly displayed and the Drive will shut down. **TEST** mode is only available when in the **BYPASS** position.]
 - The VAV terminal unit dampers, in supply fan applications, are open to prevent duct flexing or damage in a full speed, across the line starting situation.
 - The electro-mechanical motor OverLoad Relay (OLR) (S10) is adjusted to equal the Full Load Amps (FLA) value from the motor nameplate.

The OLR is mounted to the contactor assembly or back panel (depending on rating), just above the Bypass contactor. See Figure 4.1. Electrically on the output power side of the Bypass unit, the adjustable thermal OLR provides overload protection for the motor in both the Drive and Bypass operating modes. The OLR is set up in the factory to be a manual reset device, requiring operator attention if an overload trip-out is experienced.

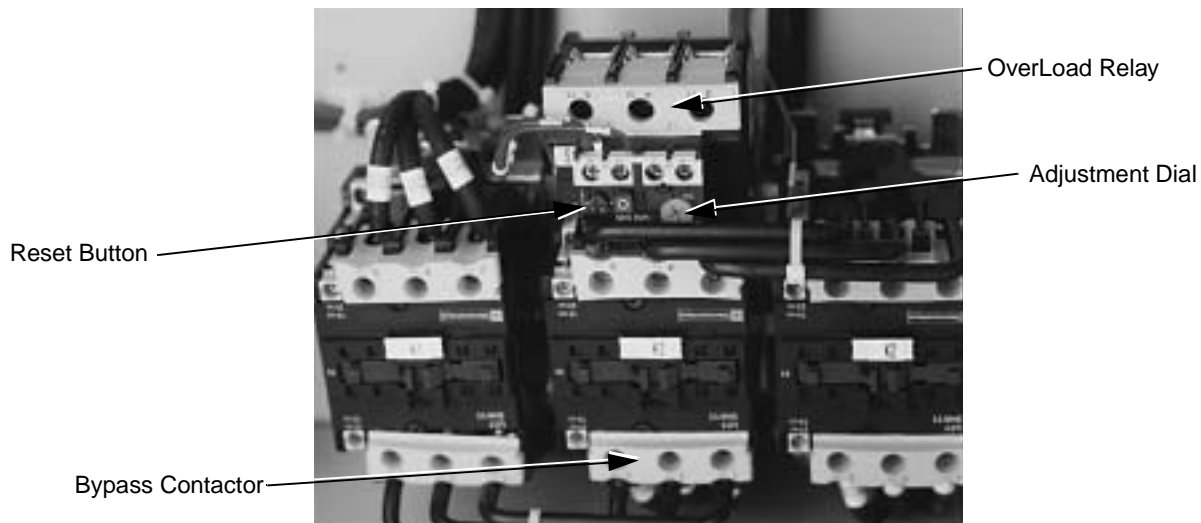

Fig 4.1 Typical Motor Overload and Contactors

IMPORTANT

To maintain overcurrent, short-circuit, and ground-fault protection, the manufacturer’s instructions for setting the motor OLR must be followed.

- 2. Apply power to the Drive and Bypass package. Ensure that all three phases are present and that the input voltage is correct for the system being set up. The **CONTROL POWER ON**, **STOP** and **AUTO SEQ** and **REF** LEDs on the control panel should be *ON* and the display will be in the “-DRIVE-/Operation” menu showing the active speed command. [Note: If the **MOTOR OL/SAFETIES FAULT** light is *ON*, press the reset button on the motor OLR (S10) and check the “safety device” circuit between terminals **TB1-1** and **TB1-2**.]

- 3. Various menus are directly available by pressing the **MENU** key (see Chapter 3). When in the “-DRIVE-/Operation” menu, the Drive can accept a run command from local (Hand mode) or remote (Auto mode) sources. Press the **MENU** key until the “-ADV-/Programming” menu is displayed. From here, any of the parameters can be accessed and changed using the **▲**, **▼**, and **DATA/ENTER** keys. See Appendix A for a list of programmable features. The “-VERIFY-/Modified Consts” menu can be used to review or modify only those parameters that have been changed from the Drive’s default values. Using the **▲**, **▼**, and **DATA/ENTER** keys as needed, verify that the parameters are correct for the Drive and installation conditions. See the *Factory Parameter Settings* printed in Table 1 and Table 2 on page 2 of the Schematic Diagram that was shipped with the unit. Consider any additional parameter settings that may be needed by this specific application.

The *Factory Parameter Settings* table documents Drive parameter settings, required to interface with the Bypass logic circuit, that have been established at the factory and stored in a dedicated location in memory as “User Initialization” values (think of it as a “back-up file”). If additional parameters are set to the specific needs of the application project, and the system operation has been checked and verified, then the “User Initialization” values should be stored in memory again by selecting and entering “1: Set Default” in parameter **o2-03**.

When there is a need for re-initialization of the “user” parameters (re-setting to the “User Initialization” values) of the Bypass unit, then a “User Initialization” function should be carried out by selecting “1110: User Initialize” in parameter **A1-03**. This will re-establish the drive set-up required for the Bypass application and any “user” parameter values that have been stored.

The factory parameter settings required to interface with the bypass logic circuit have also been stored in the digital keypad memory. If there is a need for re-initialization (re-setting to a known factory starting point for trouble-shooting purposes) of the Bypass unit, then the “back-up file” in the digital keypad memory can be copied to the drive. In parameter **o3-01** select “2: OP->INV WRITE” to carry out the copy function.

Table 1 of the schematic is also used to document parameters that have been factory set to typical values for fan and pump applications. These parameters may be changed to meet the needs of the specific application. In Table 5.1 of this manual shading is used to distinguish between settings required by the Bypass logic and those that may be changed.

- 4. From the “-ADV-/Programming” menu, go to parameter **E1-01** and select the nominal input voltage that the Drive will receive in this specific application. The overall voltage classification of the Drive cannot be changed by this parameter. However, the input voltage should be adjusted within the range available for the given voltage “class” of the Drive to match the input voltage level normally found on the jobsite. For example, 480 VAC class Drives may be employed on nominal three phase voltage distribution systems of: 380, 400, 415, 440, 460 or 480 VAC. The factory default values may need to be changed to meet the needs of the application distribution voltage.
- 5. From the “-ADV-/Programming” menu, go to parameter **E2-01** and enter the Motor rated current. Set this parameter to the Full Load Amps (FLA) rating shown on the motor nameplate. This is essential for proper Drive operation and motor overload protection.
- 6. If the unit being started has the Speed Potentiometer option, proceed directly to step 7. Otherwise, press the **MONITOR** key to return to the “-DRIVE-/Operation” menu. The **AUTO SEQ** and **REF** LEDs and the **STOP** and **CONTROL POWER ON** LEDs on the control panel should be *ON* at this time.

To start the motor in Drive mode, move the **HAND/OFF/AUTO** switch to **HAND**. The **DRIVE RUN** LED will turn *ON* and the Drive will ramp up to “6 HZ”. Verify that motor rotation is correct. [Note: In Bypass packages, the Drive is programmed at the factory for 5 seconds of DC injection braking at start (to stop a rotating motor when switching from **BYPASS** to **DRIVE**), expect to see this delay each time the Drive is started.]

If the direction of motor rotation is wrong, turn the **HAND/OFF/AUTO** switch to **OFF**; and turn the Power *OFF*! Wait for the Red **CHARGE** LED (near the Drive power terminals) to go out. When it does, swap the wires in the motor junction box for T1 & T2 or on the output terminals of the motor OLR (**S10**). Tighten the terminal lugs, reapply the power, turn to **HAND** and re-check the rotation direction.

- 7. If a Speed Potentiometer option is present, turn the Speed Potentiometer fully counterclockwise to ensure that the local speed command is zero. If necessary, press the **MONITOR** key to return to the “-DRIVE-/Operation” menu. The **AUTO SEQ** and **REF** LEDs and the **STOP** and **CONTROL POWER ON** LEDs on the control panel should be *ON* at this time.

To start the motor in Drive mode, move the **HAND/OFF/AUTO** switch to **HAND**, then rotate the Speed Potentiometer clockwise to establish a speed command in the 6 to 10 Hz range. The **DRIVE RUN** LED will turn *ON* and the Drive will ramp up to this setting. Verify that motor rotation is correct. [Note: In Bypass packages the Drive is programmed at the factory for 5 seconds of DC injection braking at start (to stop a rotating motor when switching from **BYPASS** to **DRIVE**), expect to see this delay each time the Drive is started.]

If the direction of motor rotation is wrong, turn the **HAND/OFF/AUTO** switch to **OFF**; and turn the Power *OFF*! Wait for the Red CHARGE LED (near the Drive power terminals) to go out. When it does, swap the wires in the motor junction box for T1 & T2 or on the output terminals of the motor OLR (**S10**). Tighten the terminal lugs, reapply the power, turn to **HAND**; and re-check the rotation direction.

- 8. With correct motor rotation, press the **MONITOR** key, if necessary, to return to the “-DRIVE-/Operation” menu. Using the **▲**, **▼**, and **DATA/ENTER** keys, manually run the Drive throughout its entire operating range, while observing operation. If excessive vibration of the driven load is noted at specific input frequencies, the Jump Frequency function may be used to eliminate this vibration, by programming **d3-01** through **d3-04**.
- 9. Determine whether the remote speed command is a 0-10 VDC or a 4-20 mA signal. The positive side of the signal should be connected to terminal **A2** of the Drive terminal strip. The **COMMON** of the remote speed command signal should be connected to terminal **AC** of the Drive. See the connection diagram on page 1 of the Bypass schematic. [Note: The factory default is 4-20 mA, to change to 0 to 10 VDC adjust parameter **H3-08** to “0: 0-10VDC” and move Drive DIP switch S1-2, on the Drive terminal PCB to the OFF position.]
- 10. Observe if the remote speed command can achieve the minimum and maximum speeds desired. If not, perform the following (see Chapter 5):

For 0-10 VDC input at Terminal **A2**

1. With no input, adjust the Bias (**H3-11** setting) until an output of “0.0 Hz” is obtained.
2. With full scale input, adjust the Gain (**H3-10** setting) until an output of “60.0 Hz” (or other desired maximum frequency) is obtained.

For 4-20 mA input at Terminal **A2**

1. With 4 mA input, adjust Bias (**H3-11** setting) until an output of “0.0 Hz” is obtained.
2. With 20 mA input, adjust Gain (**H3-10** setting) until an output of “60.0 Hz” (or other desired maximum frequency) is obtained.

- 11. Turn the **HAND/OFF/AUTO** switch to **AUTO**, then request a run command and speed reference signal from the building automation system to confirm remote (auto) operation.
- 12. In preparation for testing the Bypass, observe the trip setting of the circuit breaker (**CB1**). The trip point is factory set at the lowest possible setting and must be adjusted for each application. This breaker will trip due to inrush current and load inertia unless it is reset!
 - For fan applications adjust the trip setting to ten times motor FLA.
 - For pump applications adjust the trip setting to six times motor FLA.

If circuit breaker tripping is experienced at these settings during motor starting on Bypass, increase the setting gradually until the motor can be started without circuit breaker tripping.

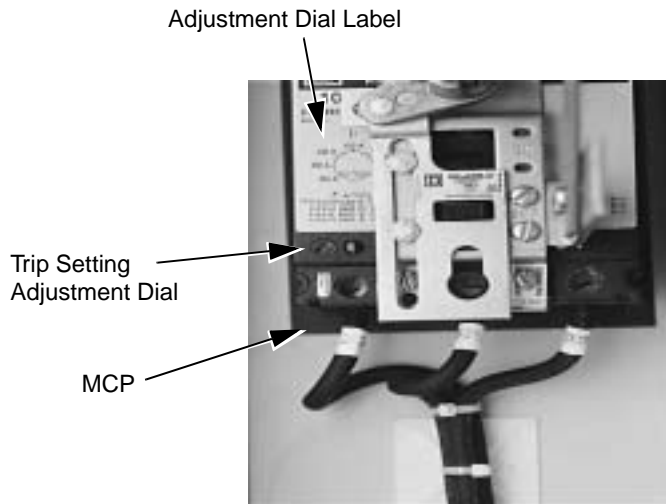

Fig 4.2 Typical MCP Circuit Breaker

IMPORTANT

To maintain overcurrent, short-circuit, and ground-fault protection, the manufacturer's instructions for setting the instantaneous-trip circuit breaker must be followed.

- 13. Turn the **HAND/OFF/AUTO** switch to **OFF** and the **DRIVE/BYPASS** switch to **BYPASS**. The Drive will ramp the motor to zero speed, then the Drive will be de-energized and control transferred to Bypass mode. Be prepared to monitor the rotation direction of the motor in Bypass operation. “Bump” the **HAND/OFF/AUTO** switch to the **HAND** position and quickly back to **OFF**. Check the motor rotation. Do not allow the motor to continue operating in **BYPASS** until rotation is correct!

If the rotation direction in Bypass is correct, skip the rest of this step. If not, carry out the following corrections:

1. Turn *OFF* the incoming power feed to the Drive. Since the correct rotation in Drive mode was previously established, do not change any output wires at the motor.
 2. Instead, verify that power to the circuit breaker is *OFF*. Then swap L1 & L2 on the input side of the circuit breaker/disconnect switch (CB1). This will affect rotation in Bypass operation only. Once connections are complete and tight, reapply the incoming power and repeat the previous step to re-check the rotation direction in Bypass mode.
- 14. Run the motor in Bypass by placing the **HAND/OFF/AUTO** switch in **HAND**. Record all the phase voltages and currents at this time.
 - 15. Select the **OFF** position of the **HAND/OFF/AUTO** switch and place the **BYPASS/DRIVE** switch in **DRIVE**. Turn to the **HAND** position and scroll the Speed Command to “60 HZ” operation. Monitor the voltages and currents in each of the output phases at full speed to make sure the voltages are balanced and the currents are within the motor nameplate rating during accel, stable speed, and decel.
 - 16. If this application requires the Drive to operate in PI mode, see Chapter 5.
 - 17. For fan applications, with the **HAND/OFF/AUTO** switch set to **AUTO**, have the building automation system give the Drive a run command and a speed command. Put the **BYPASS/DRIVE** switch into **BYPASS** and let the load speed up and stabilize. Then move the switch to **DRIVE**. Observe if the DC braking is enough to stop the fan in the time period set in parameter **b2-03** (5 sec factory setting). If not, set this parameter to its maximum setting, which is 10.0 seconds. If this is not enough, slowly increase the braking current setting (parameter **b2-02**) but do not go above 90% to protect the Drive output devices.

Bypass Operation Description

(For manual switch positions, control inputs and switch selectable functions.)

The Bypass has two modes of operation: Bypass and Drive. When in the Bypass mode the connected motor is run directly from the incoming AC line, whereas in Drive mode the motor is run from the Drive output. The **DRIVE/BYPASS** switch located on the front panel determines operating mode. Within each operating mode are two methods of control; **HAND** and **AUTO**. The **HAND/OFF/AUTO** switch on the front panel determines this control method.

Table 4.1 provides a look at various combinations of the control panel selector switch positions, control inputs to **TB1** and the status of the switch selectable options.

Selector Switches			Contact Closure Inputs			Switch Selectable Functions						Operating Mode Result
H/O/A	D/B	N/T	Run TB1 3 & 4	Enable TB1 5 & 6	Safety TB1 1 & 2	Auto Xfer		Remote Xfer		Smoke Purge		
						S103	DRV FLT	S104	TB1 25 & 26	S105	TB1 17 & 18	
O										0		None
H	D	N		X	X	0		0		0		Drive
H	D	N		0	X	0		0		0		None
H	D	N		X	0	0		0		0		None
H	D	T		X	X	0		0		0		None
H	B	N		X	X							Bypass
H	B	T		X	X							Bypass*
H	B	N		0	X					0		None
H	B	N		X	0					0		None
A	D	N	X	X	X	0		0		0		Drive
A	D	N	X	0	X	0		0		0		None
A	D	N	X	X	0	0		0		0		None
A	D	T	X	X	X	0		0		0		None
A	B	N	X	X	X							Bypass
A	B	T	X	X	X							Bypass*
A	B	N	X	0	X					0		None
A	B	N	X	X	0					0		None
H	D	N		X	X	X	0	X	0	X	0	Drive
H	D	N		X	X	X	X					Bypass
H	D	N		X	X			X	X			Bypass
H	D	N		X	X					X	X	Bypass
O	D	N		X	X					X	X	Bypass
A	D	N	X	X	X	X	0	X	0	X	0	Drive
A	D	N	X	X	X	X	X					Bypass
A	D	N	X	X	X			X	X			Bypass
A	D	N	X	X	X					X	X	Bypass

Note: A blank cell indicates the input can be in any of the possible positions.

* = Drive energized, output contactor open.

Table 4.1 Definitions:

H/O/A = Hand/Off/Auto

D/B = Drive/Bypass

N/T = Normal/Test

DRV FLT = Drive Fault Contacts

TB = Terminal Block

S10X = Slide Switch Number

X = Closed Contacts or Enabled

0 = Open Contacts or Disabled

For additional influences on the Drive behavior in Drive operating mode, consult Table 5.1 and Table 5.2. These tables explain the settings of Drive parameters required by the Bypass logic (Table 5.1) and those that are also dependent upon the control options present on the unit (Table 5.2). For Example: In the second line of Table 5.2, for a Bypass equipped with no options and switch S1-2 in the off position, the hand mode speed command is based on the setting of **d1-02** and the auto mode speed command signal is 0-10VDC.

◆ Selector Switch Functions

Operating in **HAND** position - Drive mode:

The Drive can be operated locally from the control panel by first placing the **DRIVE/BYPASS** switch in **DRIVE**. Then placing the **HAND/OFF/AUTO** switch in the **HAND** position gives the front panel control of the Drive operation. Moving the switch to **HAND** also provides the run command to the Drive. When placed into **HAND** mode the Drive begins running at the hand mode speed command.

Operating in **AUTO** position - Drive mode:

The Drive can be operated remotely by placing the **DRIVE/BYPASS** switch in **DRIVE**. Then placing the **HAND/OFF/AUTO** switch in the **AUTO** position gives a remote device (separate source or DDC) control of the Drive. In the **AUTO** position the Drive will look for a run command contact closure at terminals **TB1-3** and **TB1-4** on the relay PCB A2. Speed command signal level and source is determined by the parameter settings and the options present in the unit, see Tables 5.1 and 5.2. The **AUTO** speed command must be wired directly to the Drive terminals **A2** and **AC**, not the control terminal block **TB1**. Consult Figures 2.7 and 2.8 in Chapter 2, *Electrical Installation* for correct configuration of the speed command (analog frequency reference).

Operating in **HAND** position - Bypass mode:

The Bypass can be operated locally from the front control panel by placing the **DRIVE/BYPASS** switch in **BYPASS**. In **BYPASS** mode the Bypass contactor coil can be energized manually by placing the **HAND/OFF/AUTO** switch in **HAND** position. In Bypass mode, moving the **HAND/OFF/AUTO** switch to **HAND** causes the motor to run at full speed, directly “across the line”.

Operating in **AUTO** position - Bypass mode:

The Bypass can be operated remotely by placing the **DRIVE/BYPASS** switch in **BYPASS** and the **HAND/OFF/AUTO** switch in **AUTO**. In the **AUTO** position the Bypass will look for a run command contact closure at terminals **TB1-3** and **TB1-4** on the relay PCB A2, to control the run/stop status of “across the line” full speed motor operation.

Operating in **TEST** position - Bypass mode:

TEST position is used to energize the Drive input contactor while operating in the Bypass mode. The only valid use of the **TEST** position is in Bypass mode. In Drive mode, switching from **NORMAL** to **TEST** position will remove the Drive run command and the motor will stop. In Bypass mode, the test position powers the Drive for programming or other “tests” while keeping it isolated from the motor.

◆ Switch Selectable Functions

The switch selectable functions, **Smoke Purge**, **Auto Transfer** and **Remote Transfer** represent various methods of transferring from the Drive mode of operation to the Bypass mode. They may be enabled in any combination from none of them to all of them. See Table 4.1 for a summary of some common combinations of these switch selectable inputs.

Smoke Purge: When enabled (switch S105) this function allows a contact closure between terminals **TB1-17** and **TB1-18** to transfer motor operation to Bypass for a maximum capacity smoke control function. When in smoke purge mode, during emergency fire/smoke situations, the motor overloads and safety interlock circuit are overridden to shift the priority to protecting people rather than equipment. [**Note:** Smoke purge overrides all other control inputs and selector switches. Smoke purge operation can only be terminated by opening the contact closure at terminals **TB1-17** and **TB1-18** or by opening the Circuit Breaker (CB1).]

Auto Transfer to Bypass: When enabled (switch S103), the Bypass unit will automatically switch into Bypass mode on a Drive fault. After clearing the Drive fault condition, the function resets by moving the **HAND/OFF/AUTO** switch to the **OFF** position and waiting for the keypad to go blank. **CAUTION:** Before selecting this function in fan applications, care must be taken to ensure that the ductwork is designed to handle the pressure resulting from full speed operation with the VAV terminal unit dampers at minimum position or closed.

Remote Transfer to Bypass: When enabled (switch S104), this function allows a customer supplied contact closure, between terminals **TB1-25** and **TB1-26**, to transfer motor operation from Drive mode to Bypass mode. This remote transfer to Bypass function overrides the **DRIVE/BYPASS** manual switch. An open contact causes operation in Drive mode and a closed contact results in Bypass mode.

◆ Contact Closure Inputs and Outputs

Customer Safety Interlocks Input: Terminals **TB1-1** and **TB1-2** are used as a Drive or Bypass override from the NC contacts of the customer's safety device series circuit. Anytime all the safety device contacts are closed, the Drive or Bypass will operate. When any one of these contacts open, the Drive or Bypass will immediately stop operating. This input is momentary, when a customer safety device contact re-closes, the Drive or Bypass will return to operation.

Auto Mode Run/Stop Contact Input: **TB1-3** and **TB1-4** are input terminals used for the Run/Stop command when in the **AUTO** mode. When these input contacts close, the unit will begin running. When the contacts reopen, the unit will cease running.

Customer Supplied Interlock or Drive Enable Input: An open contact at **TB1-5** and **TB1-6** will override the run command, preventing Drive or Bypass operation until these input contacts are closed. For example this input could insure that the system dampers achieve an operating position before the fan is started in order to protect the ductwork from over pressure.

Drive Run Contact Output: Terminals **TB1-7** and **TB1-8** are an output contact that closes whenever the motor is running in Drive mode. If the Drive is receiving a run command, but a fault condition occurs, this contact will not be closed.

Bypass Run Contact Output: Terminals **TB1-9** and **TB1-10** are an output contact that closes whenever the motor is running in Bypass mode. If the Bypass is receiving a run command, but a fault condition occurs, this contact will not be closed.

Drive Fault Contact Output: Terminals **TB1-11**, **TB1-12** and **TB1-13** are a Form C set of output relay contacts, NO and NC that are activated when the Drive is in a fault condition.

Motor Overload or Customer Safeties Fault Contact Output: Terminals **TB1-14**, **TB1-15** and **TB1-16** are a Form C set of output relay contacts, N.O. and N.C. that are activated when one of the N.C. contacts of the Customer Safety device input series circuit or the motor overload relay contacts is opened.

120VAC Damper Actuator Output: Output terminals **TB1-19** and **TB1-20** are provided to energize a damper actuator circuit or solenoid air valve, typically for outdoor air intake dampers. When the motor is stopped, the output voltage is removed in order to close the dampers. Whenever the Drive or Bypass is running, the terminals output 120VAC to power a 40VA damper actuator circuit.

120VAC Control Power Output: Output terminals **TB1-21** and **TB1-22** are provided to energize additional, customer defined control logic circuits. A maximum of 100VA control power is available, the user must provide the short circuit protection.

Optional Two Motor “OR” Selection Input: Terminals **TB1-23** and **TB1-24** are used only when the “Two Motor OR option” is part of the unit. These input terminals are used for choosing between motor 1 or motor 2 when the optional **MOTOR 1/AUTO/MOTOR 2** selector switch is in the **AUTO** position.

Notes:

Chapter 5

Programming

This Manual contains descriptions of all parameters in the Drive that may be useful in Bypass applications. Parameters are listed in alpha-numerical order. Parameter number and name, along with a detailed description and its settings are described on the following pages.

Bypass Basic Programming Parameters	2
Discussion of Table 5.2 Option-Dependent Bypass Parameter Settings:	5
A1 Initialization	9
b1 Sequence	11
b2 DC Braking	16
b3 Speed Search	18
b5 PI Function	22
b8 Energy Savings	37
C1 Accel/Decel	38
d1 Preset References	39
d2 Reference (Speed Command) Limits	41
d3 Jump Frequencies	42
d4 Sequence	43
E1 V/f Pattern	44
E2 Motor Setup	50
F6 Com OPT Setup (Applies only to the LonWorks® option)	51
H1 Digital Inputs	52
H2 Digital Outputs	57
H3 Analog Inputs	58
L2 Momentary Power Loss Ride-thru Function	64
L3 Stall Prevention	65
L4 Speed Command Loss Detection	68
L5 Fault Restart	69
L6 Torque Detection	71
L8 Hardware Protection	73
o1 Monitor Configuration	75
o2 Key Selections	79
o3 Digital Operator Copy Function	82
T1 Auto-Tuning	85

Bypass Basic Programming Parameters

The basic Drive programming for a Bypass unit is different from that of a Drive installation without the Bypass option.

Several Drive parameters have been programmed at the factory to meet the needs of the Bypass logic circuit. See Table 5.1 below, the highlighted parameters are required by the Bypass logic circuit.

Table 5.1 Bypass Parameter Settings					
PARAMETER NUMBER	SETTING		UNITS	DESCRIPTION	KEYPAD DISPLAY For Bypass Setting
	For Bypass	Drive Default			
b1-01	SEE TABLE 5.2	1	N/A	Frequency Reference Selection – Selects the speed command input source	Reference Source / Terminals
b1-07	1	0	N/A	Local/Remote Run Selection – Determines acceptability of a remote run command when switching from hand (local) mode to auto (remote) mode	LOC/REM RUN Sel / Accept Extrn RUN
b1-08	1	0	N/A	Run Command Selection During Programming – Selects if run command is accepted in DRIVE Operation menu only or in all menus.	RUN CMD at PRG / Enabled
b2-03	5.0	0.0	SEC	DC Injection Braking Time At Start – Sets the braking time at Drive start, to stop a coasting motor before starting	Dcinj Time@Start / (0-10)
d1-01	10.0	0.0	HZ	Frequency Reference 1 – Hand Mode Speed Reference, used with serial communication, see Table 5.2 and H1-03	Reference 1 / (0-60)
d1-02	6.0	0.0	HZ	Frequency Reference 2 – Hand Mode Speed Reference, used without serial communication, see Table 5.2 and H1-03	Reference 2 / (0-60)
d1-04	40.0	0.0	HZ	Frequency Reference 4 – Speed Reference, used with serial communication loss and H5-04 = “4: Run at d1-04”	Reference 4 / (0-60)
E1-01	208, 240 or 480	240 or 480	VOLTS	Input Voltage Setting – Set to the nominal Voltage Setting for the incoming line	Input Voltage / (range)
F6-01	3	1	N/A	Operation Selection After Communication Error – Selects the serial com error response, alarm and continue operation	Com Bus Flt Sel / Alarm Only
H1-01	70	24	N/A	Terminal S3 Function Selection – Set for Drive run enable	Terminal S3 Sel / Drive Enable
H1-02	SEE TABLE 5.2	14	N/A	Terminal S4 Function Selection – Set for fault reset or Frequency Reference 1	Terminal S4 Sel / Multi-Step Ref 1
H1-03	SEE TABLE 5.2	3	N/A	Terminal S5 Function Selection – Set For Frequency Reference 1 or Serial Communication	Terminal S5 Sel / Multi-Step Ref 1
H2-02	3B	A	N/A	Terminals M3 - M4 Function Selection – Set for serial communication run command	Term M3-M4 Sel / Com RUN Command
H3-02	SEE TABLE 5.2	100.0	%	Terminal A1 Gain Setting	Terminal A1 Gain / (0-1000)
H3-08	SEE TABLE 5.2	2	N/A	Terminal A2 Signal Level –Signal selection, 0 to 10 VDC (Drive control board switch S1-2 off) or 4 to 20 mA (Drive control board switch S1-2 on)	Term A2 Signal / 0-10 VDC

PARAMETER NUMBER	SETTING		UNITS	DESCRIPTION	KEYPAD DISPLAY For Bypass Setting
	For Bypass	Drive Default			
H3-09	SEE TABLE 5.2	2	N/A	Terminal A2 Function Selection – Selects how this input will be used by the Drive	Terminal A2 Sel / Aux Reference
H3-13	SEE TABLE 5.2	0	N/A	Master Frequency Reference Terminal Selection – Determines which terminal (A1 or A2) will be the main speed reference source.	TA1/A2 Select / Main Fref TA1
L4-05	0	1	N/A	Frequency Reference Loss Detection Selection – Determines Drive response to loss of the frequency speed command	Ref Loss Sel / Stop
L5-01	10.0	0	N/A	Number of Re-start Attempts – Sets the number of times the Drive will perform an automatic re-start	Num of Restarts / (0-10)
L5-03	600	180	SEC	Maximum Restart Time After Fault – If not successfully started after this time, restart attempts stop and Drive faults	Max Restart Time / (.5-600.0)
o2-02	0	1	N/A	OFF Key Function During Auto Run - Enables or disables the Off key.	Oper STOP Key / Disabled
o2-03	1	0	N/A	User Initialization - Factory set parameter for user default values.	
o2-15	0	1	N/A	Hand Key Function Selection - Enables or disables the Hand and Auto keys.	Hand Key / Disabled
o3-02	1	0		Read Allowed Selection – Enables or disables keypad copy functions	Read Allowable / Enabled

Shaded Areas = Parameter settings required by the Bypass logic

The shaded Bypass Parameter Settings in Table 5.1 document Drive parameter settings, required to interface with the Bypass logic circuit, that have been established at the factory and stored in a dedicated location in the memory as “User Initialization” values (think of it as a “back-up file”).

Table 5.1 is also used to document parameters that have been factory set, for convenience, to typical values for fan and pump applications. These parameters may be changed to meet the needs of the specific application.

If additional parameters are set to the specific needs of the application project, and the system operation has been checked and verified, then the “User Initialization” values should be stored in memory again by selecting and entering “1: Set Default” in parameter **o2-03**.

When there is a need for re-initialization of the “user” parameters (re-setting to the “User Initialization” values) of the Bypass unit, then a “User Initialization” function should be carried out by selecting “1110: User Initialize” in parameter **A1-03**. This will re-establish the drive set-up required for the Bypass application and any “user” parameter values that have been stored.

The factory parameter settings required to interface with the bypass logic circuit have also been stored in the digital keypad memory. If there is a need for re-initialization (re-setting to a known factory starting point for trouble-shooting purposes) of the Bypass unit, then the “back-up file” in the digital keypad memory can be copied to the drive. In parameter o3-01 select “2: OP->INV WRITE” to carry out the copy function.

Table 5.2 Option Dependent Bypass Parameter Settings

Options	Parameters Effected by Options Specified and Settings							Drive PCB Switch S1		Resulting Hand Speed Command Source			Resulting Auto Speed Command Signal					
	b1-01	H1-02	H1-03	H3-02	H3-08	H3-09	H3-13	1	2	Keypad			Speed Pot.	Terminal A2			Serial Com #	
										d1-01	d1-02	d1-04		4-20 mA	0-10 VDC	3-15 PSIG	Run	Speed
None	1*	14*	3*	0.0	2*	0	1	Off*	On*		X			X				
None	1	14	3	0.0	0	0	1	Off	Off		X				X			
P	1	14	3	0.0	2	0	1	Off	On		X			X		X		
P and S	1	14	3	100*	2	2*	1	Off	On				X	X		X		
S	1	14	3	100	2	2	1	Off	On				X	X				
S	1	14	3	100	0	2	1	Off	Off				X		X			
G, H, Q, V	0	14	6C	0.0	2	2	0*	Off	On	X							X	X
G, H, Q, V	0	3@	6C	0.0	0	2	0	Off	Off			X			X		X	
G, H, Q, V and P	0	3@	6C	0.0	2	2	0	Off	On			X		X		X	X	
G, H, Q, V and S	1	14	6C	100	2	2	0	Off	On				X				X	X
L	0	14	6C	0.0	2	2	0	On	On	X							X	X
L	0	3@	6C	0.0	0	2	0	On	Off			X			X		X	
L and P	0	3@	6C	0.0	2	2	0	On	On			X		X		X	X	
L and S	1	14	6C	100	2	2	0	On	On				X				X	X

Definitions:

- L = LonWorks Option Card
- S = Speed Potentiometer
- V = Native Protocol (Modbus)
- P = Pneumatic Pressure Transducer (3-15 PSIG)
- G = DeviceNet Option Card
- H = Profibus Option Card
- Q = Ethernet Option Card

- * = The Drive factory default
- # = The H/O/A switch must be in the AUTO position to allow serial com. to control the Drive.
- @ = Jumpers required from S5 to S6 and S4 to SN

Parameter Reference:

- b1-01: Speed Command Input Source
0: Operator
1: Terminals
- H1-02: Terminal S4 Function Selection
3: Multi-step Ref 1
14: Fault Reset
- H1-03: Terminal S5 Function Selection
3: Multi-step Ref 1
6C: Com/Inv Sel 2
- H3-02: Terminal A1 Gain Setting
- H3-08: Terminal A2 Signal Level
0: 0 - 10 VDC
2: 4 - 20 mA
- H3-09: Terminal A2 Function Selection
0: Frequency Bias
2: Aux Reference

- H3-13: Master Frequency Reference Terminal Selection
0: Main Fref TA1
1: Main Fref TA2
- d1-01: Frequency Reference 1
- d1-02: Frequency Reference 2
- d1-04: Frequency Reference 4

Note: Hand mode run/stop for Drive and Bypass is always via the front control panel **HAND/OFF/AUTO** switch.

◆ Discussion of Table 5.2 Option-Dependent Bypass Parameter Settings:

Drive Parameter Settings for Various Combinations of Bypass and Options

Notes:

See Appendix D, Communications, for additional information on serial communication.

Hand mode run/stop for Drive and Bypass is always via the front control panel **HAND/OFF/AUTO** switch.

The **HAND/OFF/AUTO** switch must be in **AUTO** position if serial communication is to be used to control the Drive.

For "monitoring only" of Drive parameters and operation, via serial communication, the user needs only to set-up the H5-0X "Serial Com Setup" parameters. All other parameters may remain as they were factory programmed for the Bypass unit and options.

Option L, LonWorks serial communication always requires DIP switch S1-1 (terminating resistor) to be ON.

■ Options - None; Bypass with no options:

Hand mode speed command from Keypad/Operator.

Auto mode speed command input signal, 4-20 mA applied to Drive terminal A2.

Auto mode run/stop contact closure for Drive and Bypass applied to terminals TB1-3 and TB1-4.

Significant Parameter Setting	Result
b1-01 = 1: Terminals (default)	Speed command source = Terminals
H3-13 = 1: Main Fref TA2	Specific speed command source = Terminal A2
H3-08 = 2: 4-20 mA (default)	Terminal A2 is programmed for 4-20 mA (Note – Control PCB DIP switch S1-2 must also be ON)
H3-02 = 0.0	Terminal A1 gain = 0.0 (To insure no stray signal level at this unused terminal)
H3-09 = 0: Frequency Bias	Terminal A2 function is set to "bias" the terminal A1 input. Terminal A1 is not used, therefore the A2 "bias" signal becomes the speed command.
H1-03 = 3: Multi-Step Ref 1 (default)	A terminal S5 input contact closure selects d1-02 (keypad) as a preset speed. This input contact is closed when H/O/A = Hand.

■ Options - None; Bypass with no options:

Hand mode speed command from Keypad/Operator.

Auto mode speed command input signal, 0-10 VDC applied to Drive terminal A2.

Auto mode run/stop contact closure for Drive and Bypass applied to terminals TB1-3 and TB1-4.

Significant Parameter Setting	Result
b1-01 = 1: Terminals (default)	Speed command source = Terminals
H3-13 = 1: Main Fref TA2	Specific speed command source = Terminal A2
H3-08 = 0: 0-10 VDC	Terminal A2 is programmed for 0-10 VDC (Note – Control PCB DIP switch S1-2 must also be OFF)
H3-02 = 0.0	Terminal A1 gain = 0.0 (To insure no stray signal level at this unused terminal)
H3-09 = 0: Frequency Bias	Terminal A2 function is set to "bias" the terminal A1 input. Terminal A1 is not used, therefore the A2 "bias" signal becomes the speed command.
H1-03 = 3: Multi-Step Ref 1 (default)	A terminal S5 input contact closure selects d1-02 (keypad) as a preset speed. This input contact is closed when H/O/A = Hand.

■ Options - P "Pneumatic Pressure Transducer"; Bypass with pneumatic input for speed control:

Hand mode speed command from Keypad/Operator.

Auto mode speed command input signal from the pneumatic transducer, or 4-20 mA applied to Drive terminal A2.

Auto mode run/stop contact closure for Drive and Bypass applied to terminals TB1-3 and TB1-4.

Significant Parameter Setting	Result
b1-01 = 1: Terminals (default)	Speed command source = Terminals
H3-13 = 1: Main Fref TA2	Specific speed command source = Terminal A2
H3-08 = 2: 4-20 mA (default)	Terminal A2 is programmed for 4-20 mA (Transducer output is 4-20 mA) (Note – Control PCB DIP switch S1-2 must also be ON)
H3-02 = 0.0	Terminal A1 gain = 0.0 (To insure no stray signal level at this unused terminal)
H3-09 = 0: Frequency Bias	Terminal A2 function is set to “bias” the terminal A1 input. Terminal A1 is not used, therefore the A2 “bias” signal becomes the speed command.
H1-03 = 3: Multi-Step Ref 1 (default)	A terminal S5 input contact closure selects d1-02 (keypad) as a preset speed. This input contact is closed when H/O/A = Hand.

■ Options - P and S "Pneumatic Pressure Transducer" and "Speed Pot."; Bypass with pneumatic input and speed potentiometer for speed control:

Hand mode speed command from speed potentiometer.

Auto mode speed command input signal from the pneumatic transducer, or 4-20 mA applied to Drive terminal A2.

Auto mode run/stop contact closure for Drive and Bypass applied to terminals TB1-3 and TB1-4.

Significant Parameter Setting	Result
b1-01 = 1: Terminals (default)	Speed command source = Terminals
H3-13 = 1: Main Fref TA2	Main speed command source = Terminal A2 and the Aux speed command source = Terminal A1
H3-08 = 2: 4-20 mA (default)	Terminal A2 is programmed for 4-20 mA (Transducer output is 4-20 mA) (Note – Control PCB DIP switch S1-2 must also be ON)
H3-09 = 2: Aux Reference (default)	Aux Terminal (A1) function is set to be a speed command input.
H1-03 = 3: Multi-Step Ref 1 (default)	A terminal S5 input contact closure selects Aux Terminal (A1) as a preset speed. This input contact is closed when H/O/A = Hand.

■ Options - S "Speed Pot."; Bypass with speed potentiometer for speed control:

Hand mode speed command from speed potentiometer.

Auto mode speed command input signal, 4-20 mA applied to Drive terminal A2.

Auto mode run/stop contact closure for Drive and Bypass applied to terminals TB1-3 and TB1-4.

Significant Parameter Setting	Result
b1-01 = 1: Terminals (default)	Speed command source = Terminals
H3-13 = 1: Main Fref TA2	Main speed command source = Terminal A2 and the Aux speed command source = Terminal A1
H3-08 = 2: 4-20 mA (default)	Terminal A2 is programmed for 4-20 mA (Note – Control PCB DIP switch S1-2 must also be ON)
H3-09 = 2: Aux Reference (default)	Aux Terminal (A1) function is set to be a speed command input.
H1-03 = 3: Multi-Step Ref 1 (default)	A terminal S5 input contact closure selects Aux Terminal (A1) as a preset speed. This input contact is closed when H/O/A = Hand.

■ Options - S "Speed Pot."; Bypass with speed potentiometer for speed control:

Hand mode speed command from speed potentiometer.

Auto mode speed command input signal, 0-10 VDC applied to Drive terminal A2.

Auto mode run/stop contact closure for Drive and Bypass applied to terminals TB1-3 and TB1-4.

Significant Parameter Setting	Result
b1-01 = 1: Terminals (default)	Speed command source = Terminals
H3-13 = 1: Main Fref TA2	Main speed command source = Terminal A2 and the Aux speed command source = Terminal A1
H3-08 = 0: 0-10 VDC	Terminal A2 is programmed for 0-10 VDC (Note – Control PCB DIP switch S1-2 must also be OFF)
H3-09 = 2: Aux Reference (default)	Aux Terminal (A1) function is set to be a speed command input.
H1-03 = 3: Multi-Step Ref 1 (default)	A terminal S5 input contact closure selects Aux Terminal (A1) as a preset speed. This input contact is closed when H/O/A = Hand.

■ Options - G, H, L, Q, or V "Serial Communications"; Bypass with serial communication for control:

Hand mode speed command from Keypad/Operator.

Auto mode speed command input signal from serial communication.

Auto mode run/stop command for Drive from serial communication.

Auto mode run/stop contact closure for Bypass applied to terminals TB1-3 and TB1-4.

Significant Parameter Setting	Result
b1-01 = 0: Operator	Speed command source = Keypad/Operator (d1-01)
H1-03 = 6C: Com/Inv Sel 2	A terminal S5 input contact closure allows b1-01 to select d1-01 (keypad) as a preset speed. An open contact selects serial com for speed command and run/stop. This input contact is closed when H/O/A = Hand.

■ Options - G, H, L, Q, or V "Serial Communications"; Bypass with serial communication for run/stop control and speed monitoring:

Hand mode speed command from Keypad/Operator.

Auto mode speed command input signal, 0-10 VDC applied to Drive terminal A2.

Auto mode run/stop command for Drive from serial communication.

Auto mode run/stop contact closure for Bypass applied to terminals TB1-3 and TB1-4.

Significant Parameter Setting	Result
b1-01 = 0: Operator	Speed command source = Keypad/Operator (d1-01)
H3-08 = 0: 0-10 VDC	Terminal A2 is programmed for 0-10 VDC (Note – Control PCB DIP switch S1-2 must also be OFF)
H3-09 = 2: Aux Reference (default)	Terminal A2 function is set to be a speed command input. This setting also gives terminal A2 priority over d1-02 for “preset speed 2”, see Programming Manual.
H1-02 = 3: Multi-Step Ref 1 S4 must be jumpered to SN	A terminal S4 input contact closure selects A2 as “preset speed 2” speed input. The S4 input is jumpered to SN, therefore it is always closed.
H1-03 = 6C: Com/Inv Sel 2	A terminal S5 input contact closure allows b1-01 to select d1-01 (keypad) as a preset speed. An open contact selects serial com for the run/stop command (the serial com speed command is overridden by the preset speed above). This input contact is closed when H/O/A = Hand.
H1-04 = 4: Multi-Step Ref 2 (default) S6 must be jumpered to S5	A terminal S6 input contact closure selects d1-04 (keypad) as a speed input. When open, the speed command is determined by “preset speed 2”. This input contact is closed when H/O/A = Hand.

Options - G, H, L, Q, or V and P "Serial Communications" and "Pneumatic Pressure Transducer"; Bypass with serial communication for run/stop control and speed monitoring, with pneumatic input for speed control:

Hand mode speed command from Keypad/Operator.

Auto mode speed command input signal from the pneumatic transducer, or 4-20 mA applied to Drive terminal A2.

Auto mode run/stop command for Drive from serial communication.

Auto mode run/stop contact closure for Bypass applied to terminals TB1-3 and TB1-4.

Significant Parameter Setting	Result
b1-01 = 0: Operator	Speed command source = Keypad/Operator (d1-01)
H3-08 = 2: 4-20 mA (default)	Terminal A2 is programmed for 4-20 mA (Transducer output is 4-20 mA) (Note – Control PCB DIP switch S1-2 must also be ON)
H3-09 = 2: Aux Reference (default)	Terminal A2 function is set to be a speed command input. This setting also gives terminal A2 priority over d1-02 for “preset speed 2”, see Programming Manual.
H1-02 = 3: Multi-Step Ref 1 S4 must be jumpered to SN	A terminal S4 input contact closure selects A2 as “preset speed 2” speed input. The S4 input is jumpered to SN, therefore it is always closed.
H1-03 = 6C: Com/Inv Sel 2	A terminal S5 input contact closure allows b1-01 to select d1-01 (keypad) as a preset speed. An open contact selects serial com for the run/stop command (the serial com speed command is overridden by the preset speed above). This input contact is closed when H/O/A = Hand.
H1-04 = 4: Multi-Step Ref 2 (default) S6 must be jumpered to S5	A terminal S6 input contact closure selects d1-04 (keypad) as a speed input. When open, the speed command is determined by “preset speed 2”. This input contact is closed when H/O/A = Hand.

Options - G, H, L, Q, or V and S "Serial Communications" and "Speed Pot."; Bypass with serial communication for control, with hand mode speed potentiometer:

Hand mode speed command from speed potentiometer.

Auto mode speed command input signal from serial communication.

Auto mode run/stop command for Drive from serial communication.

Auto mode run/stop contact closure for Bypass applied to terminals TB1-3 and TB1-4.

Significant Parameter Setting	Result
b1-01 = 1: Terminals (default)	Speed command source = Terminals
H3-13 = 0: Main Fref TA1 (default)	Specific speed command source = Terminal A1
H1-03 = 6C: Com/Inv Sel 2	A terminal S5 input contact closure allows b1-01 to select terminals and the speed pot. as the speed command. An open contact selects serial com for speed command and run/stop. This input contact is closed when H/O/A = Hand.

◆ A1 Initialization

The initialization group contains parameters associated with initial setup of the Drive. Parameters involving the display language, access levels, initialization and password are located in this group.

■ A1-00 Select Language

Setting	Description
0	English (<i>factory default</i>)
1	Japanese
2	Deutsch
3	Francais
4	Italiano
5	Espanol
6	Portugues

The setting of parameter A1-00 determines which international language the Drive will use to display non-numerical text. The A1-00 parameter will not be changed by an Initialization of the Drive (A1-03= “1110: User Initialize”, “2220: 2-Wire Initial”, or “3330: 3-Wire Initial”).

If the Drive is accidentally set to a language unfamiliar to the operator, locating the parameter to change the operator language can be done by performing the following:

1. Press the MENU key until the “-ADV-” MENU is shown in the upper left corner of the digital operator.
2. Press the DATA/ENTER key to enter the programming menu. The first parameter shown is A1-00 (Select Language).
3. Press the DATA/ENTER key again and use the INCREASE and DECREASE arrow keys to choose the preferred language from the list below:

0 : English
1 : Japanese
2 : Deutsch (German)
3 : Francais (French)
4 : Italiano (Italian)
5 : Español (Spanish)
6 : Portugues (Portuguese)

■ A1-01 Access Level Selection

Setting	Description
0	Operation Only
1	User Level
2	Advanced Level (<i>factory default</i>)

A1-01 can be used to allow access to and permission to change all Drive parameters. If the Drive is programmed for Operation Only (A1-01= “0: Operation Only”), then only the OPERATION and the PROGRAMMING menus are accessible. Within the PROGRAMMING menu only parameters A1-01 and A1-04 are adjustable.

If A1-01 is configured for Advanced Access (A1-01= “2: Advanced Level”), then all menus and all parameters are shown. If the Access Level Selection is set to Advanced, all parameters should be adjustable unless:

1. The Drive parameters are password protected (A1-04) which will prevent access to A1-00 through A1-03 and all A2 parameters.
2. A digital input has been configured as a Program Lockout (H1-0X= 1B) is active.
3. During serial communication writing, if a parameter change is also attempted via the digital operator, a “BUSY - WRITE PROTECTED” message will display. Parameter change will not be possible from the digital operator until an Enter command is received via the serial communication to finish the serial writing process.

■ A1-03 Initialize Parameters

Setting	Description
0	No Initialize (<i>factory default</i>)
1110	User Initialize
2220	2-Wire Initialize
3330	3-Wire Initialize

The Drive can be set back to one of three default states via the A1-03 parameter.

1. User Initialization – 1110: The modified Drive parameters are returned to the values selected as user settings. User settings are stored when parameter o2-03= “1: Set Defaults”.
2. 2-Wire Initialization – 2220: The Drive parameters are returned to factory default values with digital inputs S1 and S2 configured as Forward Run and Reverse Run, respectively.
3. 3-Wire Initialization – 3330: The Drive parameters are returned to factory default values with digital inputs S1, S2, and S5 configured as Run, Stop, and Forward/Reverse respectively.

After an initialization is performed, parameter A1-03 will automatically be set back to 0.

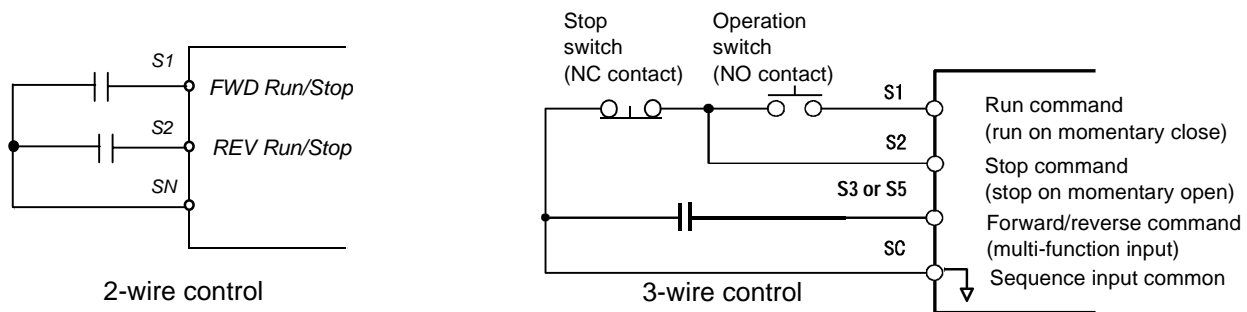

Fig 5.1 2 & 3-Wire Control Wiring Examples

IMPORTANT

Some parameters are unaffected by either the 2-Wire or 3-Wire initialization. The following parameters will not be reset when parameter A1-03=2220 or 3330:

- | | |
|-------|--|
| A1-00 | Language Selection |
| E1-03 | V/f Pattern Selection |
| o2-04 | kVA Selection |
| o2-09 | Initialization Specification Selection |

■ A1-04 Password Entry

Setting Range: 0 to 9999

Factory Default: 0

If parameters A1-01 through A1-03 and all of the A2 parameters are locked (unchangeable) they can be unlocked by entering the correct password number into A1-04.

Once the correct password number is entered and the specified parameters are unlocked, a 2-Wire or 3-Wire initialization will reset the password to 0000.

■ A1-05 Select Password

Setting Range: 0 to 9999

Factory Default: 0

When the value set into A1-04 does NOT match the value set into A1-05, parameters A1-01 thru A1-03 and A2-32 cannot be changed. All other parameters determined by A1-01 can be changed. Parameter A1-05 can be accessed by displaying parameter A1-04, then press and hold the RESET key along with the MENU key simultaneously.

◆ b1 Sequence

The Sequence Group contains parameters associated with starting and stopping the Drive. Parameters involving the Run Command, Speed Reference location, Stopping Method and Hand/Auto changeover are located in this group.

■ b1-01 Reference (Speed Command) Source Selection

This is one of the special parameter settings required by the Bypass logic circuit. See Table 5.1.

The addition of serial communication to the Drive and Bypass unit, after shipment to the job site, would be the only reason for changing this parameter. See Table 5.2 for the parameter settings required to enable serial communication in the field.

Setting	Description
0	Operator - Digital Preset Speed d1-01
1	Terminals - Analog Input Terminal A1 (or Terminal A2, see Parameter H3-13)
2	Serial Com - RS-485 Terminals R+, R-, S+ and S-
3	Option PCB - Option Board connected at 2CN

In order to run the Drive and motor with the BYPASS/DRIVE switch in the DRIVE position: the Drive must receive a Run command and a speed command. Parameter b1-01 specifies from where the speed command is received when the Drive is in the **AUTO** mode. Switching into the **AUTO** mode can be done by turning the Hand/Off/Auto selector switch to **AUTO** while the Drive is stopped.

IMPORTANT

If a Run command is input to the Drive but no corresponding speed command is input, the Run indicator on the digital operator will turn on and the STOP indicator on the digital operator will blink.

If you want the Drive to follow the speed command set by the digital operator: Use the **HAND** mode by turning the **HAND/OFF/AUTO** selector switch to **HAND**. The speed command can then be entered into the U1-01 monitor parameter in the “-DRIVE-” Menu.

If you want the Drive to follow an AUTO analog speed command: Connect a 0 – 10 VDC speed command signal between terminals A1 and AC or a 4 – 20 mA speed command signal to terminals A2 and AC. Select the AUTO position of the Hand/Off/Auto switch.

If you want the Drive to receive the speed command from serial communication: Set the parameter indicated in Table 5.2 for the desired serial communication option. Connect the RS-485/422 serial communications cable to terminals R+, R-, S+, and S- on the control I/O terminal block. The **HAND/OFF/AUTO** selector switch must be in the **AUTO** position.

■ b1-02 Run Source

Setting	Description
0	Operator
1	Terminals <i>(factory default)</i>
2	Serial Com
3	Option PCB

To successfully operate the Drive or Bypass and motor remotely, an external run command must be received by the Drive and Bypass unit. Parameter b1-02 specifies from where the run command for the Drive will be accepted.

This parameter is by default set to “1: Terminals.” This setting is required by the Bypass logic circuit.

To issue a run command from the control panel: Turn the Hand/Off/Auto switch to the **HAND** position.

To issue a run command from a remote source: Turn the Hand/Off/Auto switch to the **AUTO** position. A contact closure between terminals TB1-3 and TB1-4 will control the Drive or Bypass start and stop operation.

To issue a run command via serial communication: Set the parameters indicated in Table 5.2 for the desired serial communication option. Connect the RS-485/422 serial communication cable to R+, R-, S+, and S- on the removable terminal block.

■ b1-03 Stopping Method

There are four methods of stopping the Drive when the Run command is removed.

Setting	Description
0	Ramp to Stop <i>(factory default)</i>
1	Coast to Stop
2	DC Injection to Stop
3	Coast w/Timer

“0:Ramp to stop”: When the Run command is removed, the Drive will decelerate the motor to 0 rpm. The rate of deceleration is determined by the active deceleration time. The factory default Decel Time is in parameter C1-02.

When the output frequency has dropped below the DC Injection Start Frequency in b2-01 (Default = 0.5HZ) DC current will be injected in the motor at a level determined by b2-02 (50% Default). The DC Injection condition will occur for the time specified by b2-04 (0.0 Default), to establish the end point of the ramp. DC injection can be used to insure the motor is at zero rpm prior to the Drive shutting off.

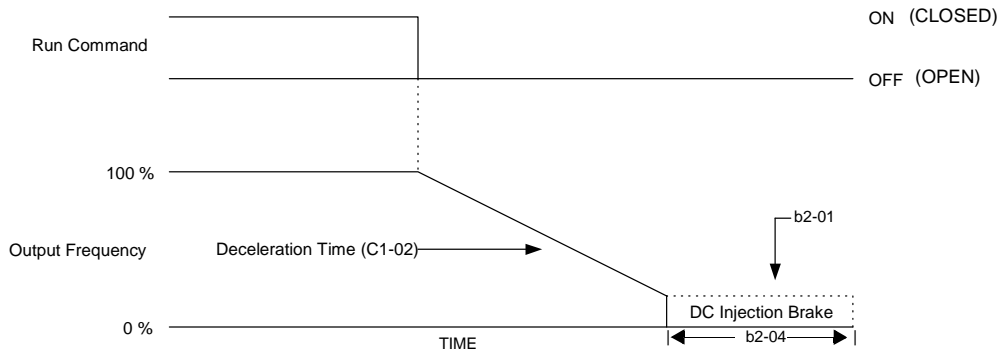

Fig 5.2 Deceleration to Stop

The actual deceleration time can be determined by the following formula

$$\text{Time to Stop} = \frac{\text{Output Freq. at time of stop command}}{\text{Maximum Frequency (E1 - 04)}} \times \text{Setting of active Decel Time (C1 - 02 or C1-04)}$$

If S-Curve characteristics are specified by the Drive programming, they will add to the total time to stop.

1:Coast to stop: When the Run command is removed, the Drive will turn off its output and the motor will coast (uncontrolled deceleration). The friction of the driven equipment will eventually overcome any residual inertia of the system and the rotation will stop.

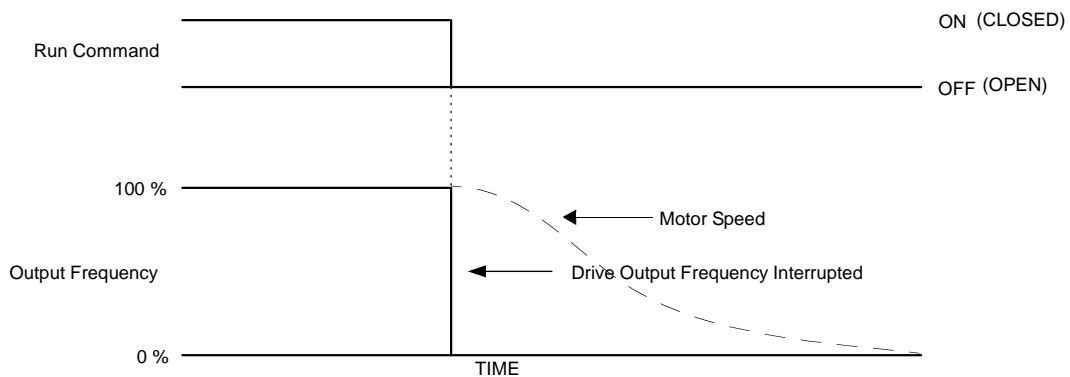

Fig 5.3 Coast to Stop

IMPORTANT

After a stop is initiated, a subsequent Run commands input before the Minimum Baseblock Time (L2-03) has expired, will be ignored.

2:DCInj to Stop: When the Run command is removed, the Drive will Baseblock (turn off its output) for the Minimum Baseblock Time (L2-03). Once the Minimum Baseblock Time has expired, the Drive will inject DC current into the motor windings to lock the motor shaft. The stopping time will be reduced as compared to Coast to Stop. The level of DC Injection current is set by parameter b2-02 (50% Default). The DC Injection brake time is determined by the set value in b2-04 and the output frequency at the time the Run command is removed.

$$\text{DC Injection Brake Time} = \frac{(b2 - 04) \times 10 \times \text{Output Frequency}}{\text{Maximum Frequency (E1 - 04)}}$$

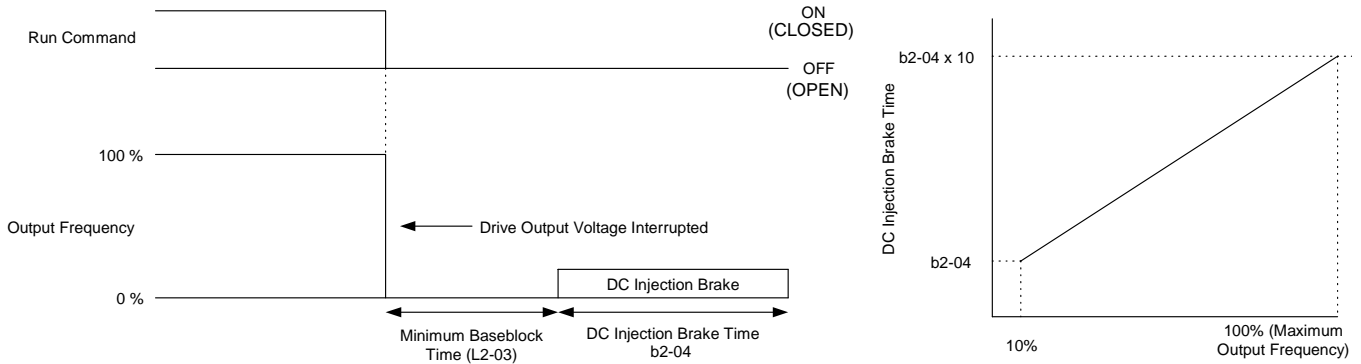

Fig 5.4 DC Injection Braking to Stop

IMPORTANT

If an overcurrent (OC) fault occurs during DCInj to Stop, lengthen the Minimum Baseblock Time (L2-03) until the fault no longer occurs.

3: Coast w/Timer: When the Run command is removed, the Drive will turn off its output and the motor will coast to a stop. If a Run command is input before time T (Operation Wait Time) expires, the Drive will not run and the Run command will need to be cycled before operation can occur. The time T (Operation Wait Time) is determined by the output frequency when the Run command is removed and the active deceleration time (C1-02).

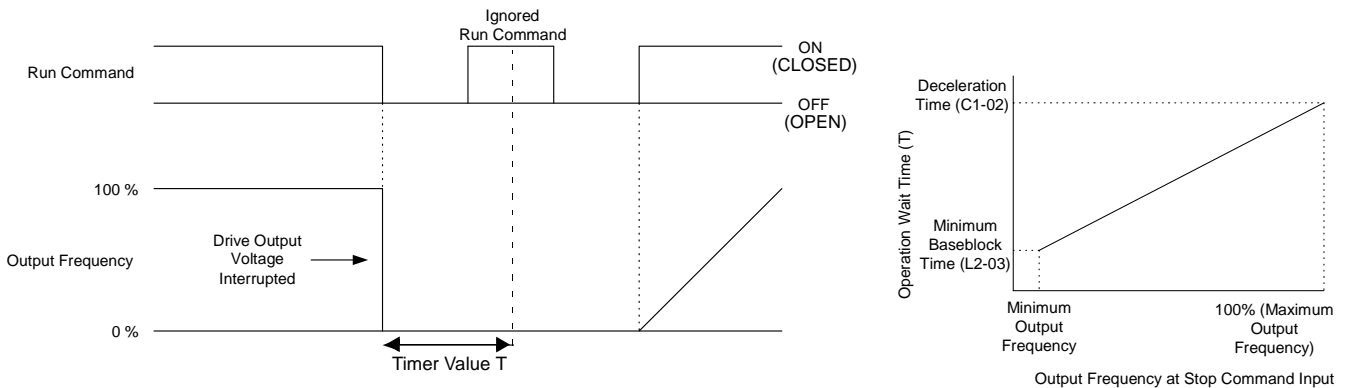

Fig 5.5 Coast to Stop with Timer

■ b1-04 Reverse Operation

Setting	Description
0	Reverse Enabled
1	Reverse Disabled (<i>factory default</i>)
2	Exchange Phase
3	ExchgPhs, Rev Dsbl

For some applications reverse motor rotation is not applicable and may even cause problems (e.g., air handling units, pumps, etc.). Setting parameter b1-04 to 1 or 3 will cause the Drive to ignore any inputs for reverse operation. Setting parameter b1-04 to either 2 or 3 will change the motor shaft rotation when a Forward Run command is given by exchanging the order of the output phasing.

The factory default setting of parameter b1-04 is “1: Disabled”. When b1-04= “1: Disabled”, reverse operation is prohibited and no exchanging of output phasing occurs.

■ b1-07 Local/Remote Run Selection

Setting	Description
0	Cycle Extern Run
1	Accept Extrn Run (<i>factory default</i>)

When the Drive is switched between the Local (Hand) mode (the digital operator) to the Remote (Auto) mode by the Hand/Off/Auto selector switch, there is the possibility that a Run command is already present (i.e. a contact closure between terminals TB1-3 and TB1-4. Parameter b1-07 determines whether the Drive will:

Ignore the external Run command until it is removed and re-instated (b1-07= “0: Cycle Extern Run”)

OR

Accept the already present Run command and immediately begin acceleration to the commanded speed (b1-07= “1: Accept Extrn Run”).

IMPORTANT

When switching from local mode to Auto mode when b1-07= “1:Accept Extrn Run” the Drive may start unexpectedly if the Run command is already applied. Be sure all personnel are clear of rotating machinery and electrical connections prior to switching between local mode and Auto mode.

■ b1-08 Run Command Selection During Programming

Setting	Description
0	Disabled
1	Enabled (<i>factory default</i>)

As a convenience to the user, the Drive will respond to a Run input even when the digital operator is being used to adjust parameters. If it is necessary that external Run commands not be recognized while the Drive is being programmed, set b1-08= “0: Disabled”.

■ b1-11 Drive Delay Time Setting

Setting Range: 0 to 600 Seconds

Factory Default: 0 Seconds

If a time is set into parameter b1-11, the Drive will delay executing any run command until the b1-11 time has expired. During Drive delay time execution, the digital operator will display:

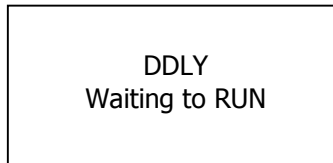

Both the ALARM and Run indicators will blink while the Drive waits to execute the Run command.

◆ b2 DC Braking

The DC Braking Group contains parameters associated with the DC injection braking feature. Parameters involving the starting frequency, current level, braking time, and motor pre heat current level are located here.

■ b2-01 DC Injection Braking Start Frequency

Setting Range: 0.0 to 10.0 Hz

Factory Default: 0.5 Hz

Parameter b2-01 sets the output frequency where the Drive begins DC Injection during Ramp to stop, in order to lock the rotor of the motor and established the end point of the ramp. If $b2-01 < E1-09$ (Minimum Frequency), then DC Injection begins at E1-09.

Parameter b2-01 also determines the output frequency that the Drive must be at or below before a Zero Speed condition is considered true. This affects any digital output configured as a Zero Speed signal (H2-0x= "1: Zero Speed").

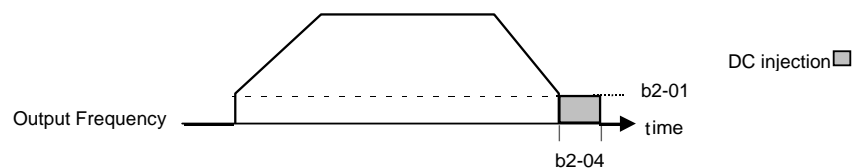

Fig 5.6 DC Injection Braking During Stopping

■ b2-02 DC Injection Braking Current

Setting Range: 0 to 100%

Factory Default: 50%

The level of DC Injection Braking Current affects the strength of the magnetic field attempting to lock the motor shaft. Increasing the level of current will increase the amount of heat generated by the motor windings and should only be increased to the level necessary to hold the motor shaft. DC Injection current is set in percentage of Drive rated output current. Drive rated output current is stated on the Drive nameplate.

■ b2-03 DC Injection Braking Time at Start

b2-04 DC Injection Braking Time at Stop

Setting Range: 0.00 to 10.00 Seconds

Factory Default: b2-03 = 5.00 Seconds

b2-04 = 0.00 Seconds

b2-03 is one of the special parameter settings required by the Bypass logic circuit. See Table 5.1.

The Drive can be programmed to automatically DC Inject for a predetermined amount of time prior to accelerating to speed (b2-03) and/or at the end of a Ramp to stop (b2-04). Parameter b2-03 can be used to stop a rotating motor prior to attempting acceleration (i.e. a wind milling fan). If DC Injection braking at start or Speed Search is not enabled, attempting to Drive a spinning motor may cause nuisance tripping.

Parameter b2-04 can be used to resist any residual motion of the load after the deceleration has finished.

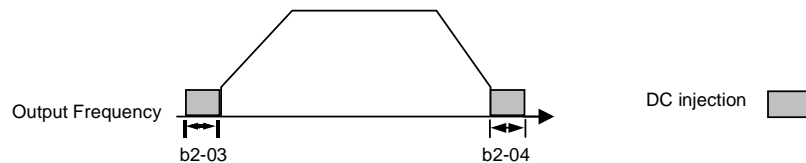

Fig 5.7 DC Injection Braking During Starting and Stopping

Parameter b2-04 also serves the function of affecting the length of time DC Injection to stop (b1-03= “2: DC Injection to Stop”) will occur.

■ b2-09 Motor Pre-Heat Current

Setting Range: 0 to 100%

Factory Default: 0%

A DC current can be circulated within the motor windings while the motor is stopped. The current will produce heat within the motor and prevent condensation. Parameter b2-09 determines the percentage of Drive rated output current that will be used for the motor pre-heat function. This function can be useful in applications where the motor sits for extended periods of time in humid conditions. Motor pre-heating can only be initiated by closing a digital input programmed as a Motor Pre-heat Input (H1-0x= 60). Check with the motor manufacturer to determine the maximum acceptable current level the motor can withstand when stopped. Be sure not to exceed the motor manufacturers recommended level.

◆ b3 Speed Search

The Speed Search function allows the Drive to determine the speed of a motor shaft that is being driven by rotational inertia. Speed Search will allow the Drive to determine the speed of the already rotating motor and begin to ramp the motor to a set speed without first having to bring it to a complete stop. When a momentary loss of supply power is experienced, the Drive output is turned off. This results in a coasting motor. When power returns, the Drive can determine the speed of the coasting motor and start without requiring it to be brought to minimum speed. Speed Search can be programmed to always be active by setting b3-01 or it can be commanded by remote contact closure by setting a digital input.

There are two forms of Speed Search in the Drive, the speed estimation method and the current detection method.

IMPORTANT

When setting the Drive for remote Speed Search input, via a contact closure, the method of Speed Search is determined by the setting of b3-01. If b3-01= "0: SpdsrchF Disable" then the remote input will initiate speed estimation method, and if b3-01= "2: SpdsrchI Disable", then the remote input will start the current detection method.

Parameters L2-03 and L2-04 also affect the current detection method of Speed Search operation.

■ b3-01 Speed Search Selection

Setting	Description
0	SpdsrchF Disable
1	SpdsrchF Enable
2	SpdsrchI Disable (<i>factory default</i>)
3	SpdsrchI Enable

Speed Estimation: Method (b3-01= 0 or 1) The speed estimation method will calculate the speed using measurements of residual motor fields. The speed estimation version is bi-directional and will determine both the motor speed and direction. To enable speed estimation Speed Search at start, set b3-01= "1: SpdsrchF Enable".

IMPORTANT

If the speed estimation method of Speed Search is to be used, then Auto-tuning must be performed prior to using Speed Search. If the length of cable between the Drive and motor is ever changed after Auto-tuning then Auto-tuning should be performed again.

IMPORTANT

The speed estimation mode cannot be used when there are multiple motors operated by one Drive or the motor is two or more frames smaller than the standard size motor per the Drive capacity.

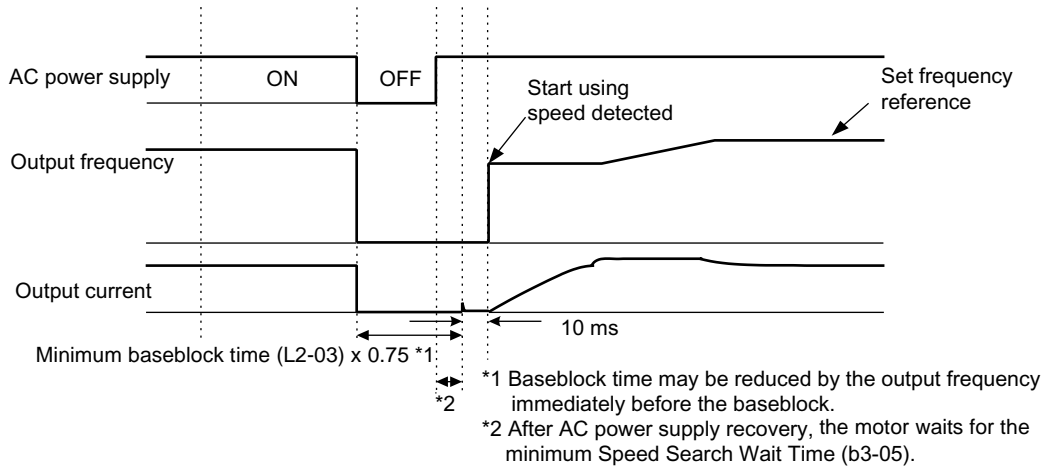

Fig 5.8 Speed Search (Estimated Speed Method) after momentary power loss where the power loss time is less than the minimum baseblock time

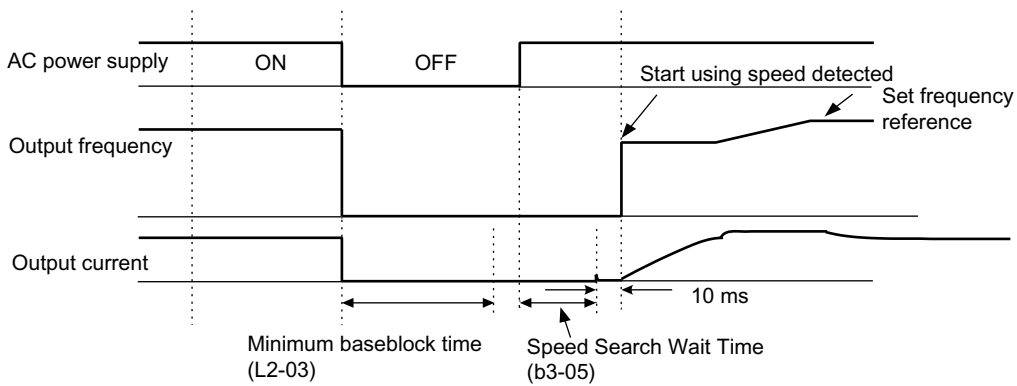

Fig 5.9 Speed Search (Estimated Speed Method) after momentary power loss where the power loss time exceeds the minimum baseblock time

Current Detection Method (b3-01=2 or 3): The current detection method starts searching from a predetermined frequency while monitoring the Drive output current to determine when the rotor speed and the Drive output speed (frequency) match. The current detection version is not bi-directional. To enable current detection Speed Search at start set b3-01= “3: SpdsrchI enable” and program any digital input equal to Speed Search 1 (H1-0x= 61) or Speed Search 2 (H1-0x= 62). Speed Search 1 will start searching from the max. frequency (E1-04) and ramp down to meet the rotor speed. Speed Search 2 will start searching from the set frequency and ramp down to meet the rotor speed.

IMPORTANT | If a UV1 fault occurs when current detection Speed Search is attempted, increase the setting of L2-04.

IMPORTANT | If an OC fault occurs when Speed Search is attempted after power loss recovery, increase the setting of L2-03.

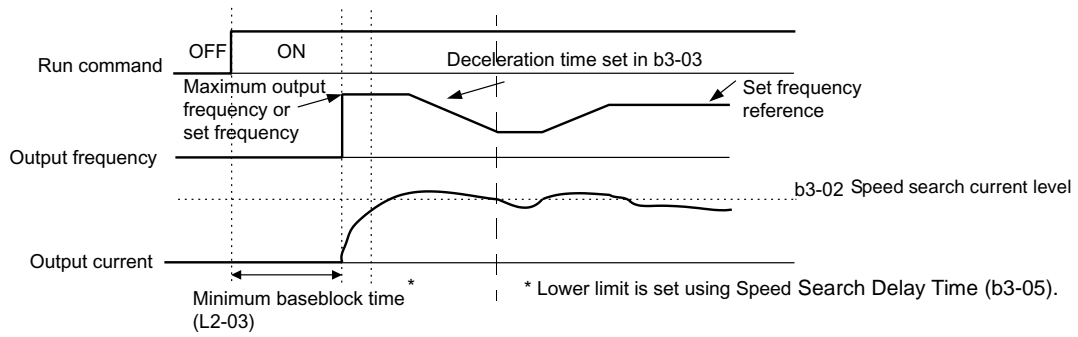

Fig 5.10 Speed Search (Current Detection Method) at Startup

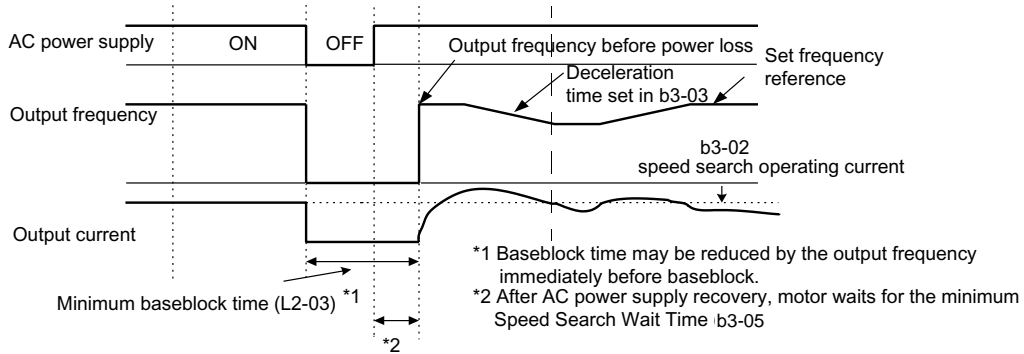

Fig 5.11 Speed Search (Current Detection Method) after momentary power loss where the power loss time is less than the minimum baseblock time

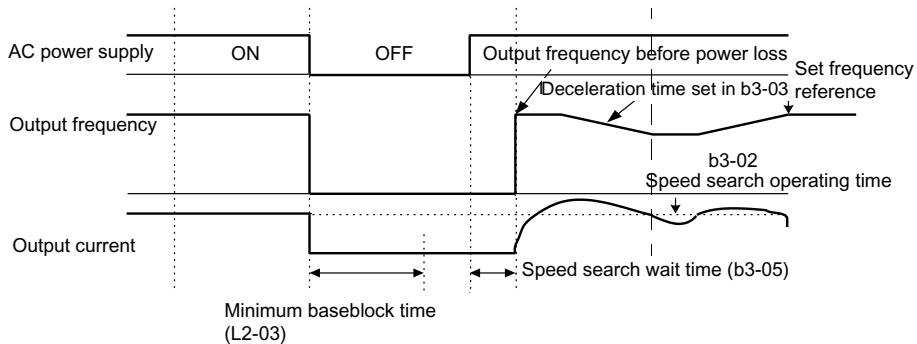

Fig 5.12 Speed Search (Current Detection Method) after momentary power loss where the power loss time exceeds the minimum baseblock time

Setting of b3-01	Automatic Speed Search for all RUN commands and momentary power loss	Speed Search Method Used for Multi-function inputs
0	No	Speed Estimation
1	Yes - Speed Estimation	
2	No	Current Detection
3	Yes - Current Detection	

■ b3-02 Speed Search Deactivation Current

Setting Range: 0 to 200% of Drive rated output current

Factory Default: 120% of Drive rated output current

When using the current detection method of Speed Search, parameter b3-02 sets the current level that will determine when the search is complete and the rotor and output speeds match. When the output frequency is higher than the actual rotor speed the slip causes the current to be high. As the output frequency is lowered, the closer it comes to the rotor speed, the lower the current draw will be. When the output current drops below the level as set in b3-02 (100% = Drive Rated Current) the output frequency stops decreasing and normal operation resumes.

■ b3-03 Speed Search Deceleration Time

Setting Range: 0.1 to 10.0 Seconds

Factory Default: 2.0 Seconds

Parameter b3-03 sets the deceleration ramp used by the current detection method of Speed Search when searching for the motor's rotor speed. Even if Speed Search 2 is selected, for Speed Search at start, the time entered into b3-03 will be the time to decelerate from maximum frequency (E1-04) to minimum frequency (E1-09).

■ b3-05 Speed Search Delay Time

Setting Range: 0.0 to 20.0 Seconds

Factory Default: 0.2 Seconds

In cases where an output contactor is used between the Drive and the motor, extra waiting time is provided after power returns and before Speed Search is performed. This extra time allows for the contactor to operate. When Speed Search at start is used, b3-05 will serve as the lower limit of the Minimum Baseblock Time (L2-03).

■ b3-14 Bi-Directional Speed Search Selection

Setting	Description
0	Disabled
1	Enabled (<i>factory default</i>)

The b3-14 parameter can be used to turn off the bi-directional capabilities of the Speed Estimation form of Speed Search. By turning off the bi-directional capability, the speed search will only try to match the speed in the last known direction.

◆ b5 PI Function

The capability to accept an analog signal as feedback for a PI (Proportional + Integral) control function is built into the Drive.

Speed Command / PI Setpoint

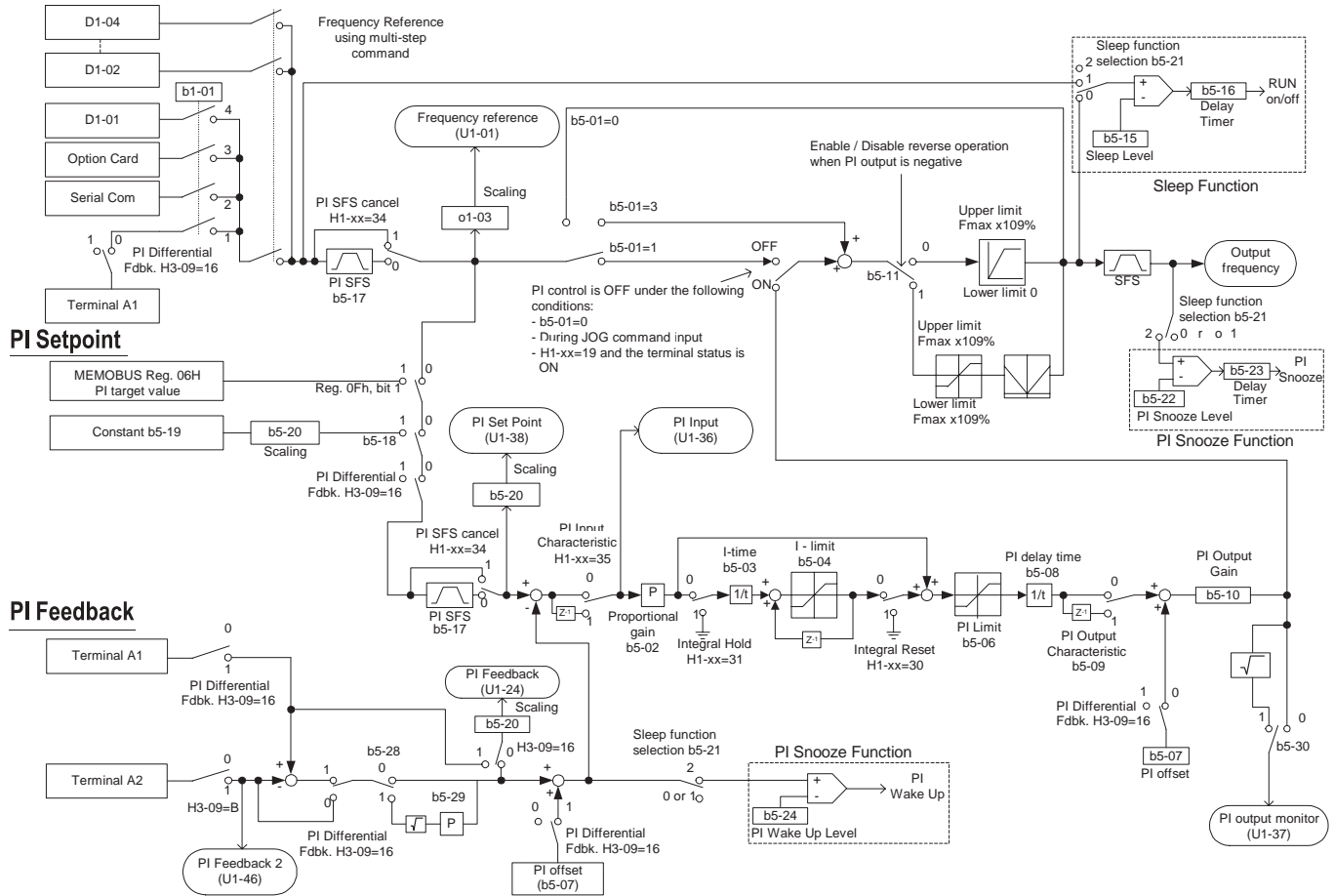

Fig 5.13 PI Block Diagram

Bypass units are shipped with the parameters in Table 5.1 and Table 5.2 pre-established.

To add PI control to a Bypass unit; observe the control options that are included in the unit by review of the model number on the nameplate (inside of door and external lower right side) as well as the option codes and model number description in Chapter 1. Then revise the parameter settings indicated in Table 5.3 and 5.4 for a line of data, in Table 5.4, with the same (or similar) combination of options. This will add the logic required for PI control to that required for Bypass control.

Table 5.3 includes parameters that are the same regardless of control options specified while Table 5.4 provides detail on the option dependent parameters.

Table 5.3 PI Control Parameter Settings in Bypass Units					
PARAMETER NUMBER	SETTING		UNITS	DESCRIPTION	KEYPAD DISPLAY For Bypass Setting
	Bypass & PI Control	Bypass Default			
b1-01	SEE TABLE 5.4	SEE TABLE 5.2	N/A	Frequency Reference Selection – Selects the speed command input source	Reference Source / Terminals
b5-01	1	0	N/A	PI Mode Selection – Enables PI mode	PI Mode Setting / PI Mode
H1-03	19	SEE TABLE 5.2	N/A	Terminal S5 Function Selection – Set for PI Disable, turn off PI controller	Terminal S5 Sel / PI Disable
H1-04	SEE TABLE 5.4	4	N/A	Terminal S6 Function Selection – Set for various operating modes	Terminal S6 Sel / Com/Inv Sel 2, for example
H3-02	100	SEE TABLE 5.2	%	Terminal A1 Gain Setting	Terminal / (0-1000)
H3-08	SEE TABLE 5.4	SEE TABLE 5.2	N/A	Terminal A2 Signal Level – Signal selection, 0 to 10 VDC (Drive control board switch S1-2 off) or 4 to 20 mA (Drive control board switch S1-2 on)	Term A2 Signal / 0-10 VDC
H3-09	B	SEE TABLE 5.2	N/A	Terminal A2 Function Selection – Selects how this input will be used by the Drive	Terminal A2 Sel / PI Feedback
H3-13	1	SEE TABLE 5.2	N/A	Master Frequency Reference Terminal Selection – Determines which terminal (A1 or A2) will be the main speed reference source.	TA1/A2 Select / Main Fref TA2
o1-03	1	0	%	Digital Operator Display Selection – Set for percent	Display Scaling / (0-39999)
o1-06	1	0	N/A	User Monitor Selection Mode – Enables a custom display for PI Control monitoring	Monitor Mode Sel / 1: 3 Non Selectable
o1-08	24	3	N/A	Third Line User Monitor Selection – Display PI Feedback	3rd Monitor Sel / 24: PI Feedback

■ Digital Operator and Control Panel Display for PI Control

In Table 5.3, the o1-0X parameter listed setup the Drive display to indicate 3 variables for PI control as in Figure 5.14 when the HAND/OFF/AUTO switch is in **AUTO**.

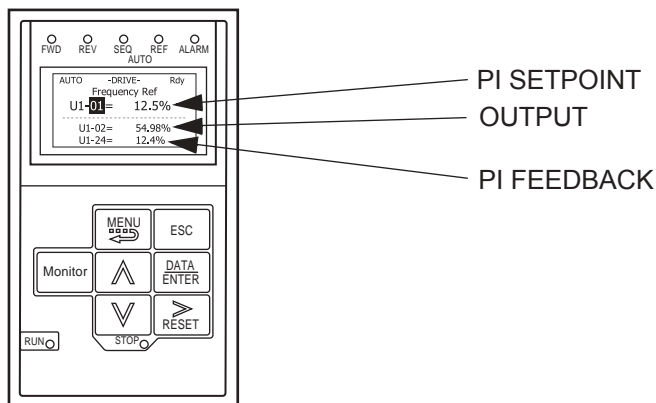

Fig 5.14 Drive Display for PI Control, AUTO Mode

When the HAND/OFF/AUTO switch is transferred to the **HAND** position, the display will automatically change to indicate the speed command, as in Figure 5.15.

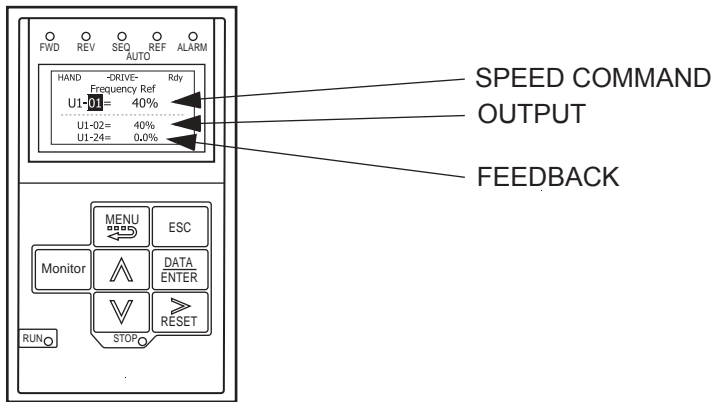

Fig 5.15 Drive Display for PI Control, HAND Mode

Table 5.4 Option Dependent Drive PI Control Parameters in Bypass Units

Options	Parameters Effected by Options Specified			Drive PCB Switch S1		Resulting Hand Speed Command Source		Auto: PI Feedback Terminal A2		Auto: Run/Stop		Auto: PI Setpoint		
	b1-01	H1-04	H3-08	1	2	Keypad U1-01	Speed Pot.	4-20 mA	0-10 VDC	TB1 3&4	Serial #	Keypad U1-01	Serial #	Speed Pot.
None	0	4*	2*	Off	On*	X		X		X		X		
None	0	4	0	Off*	Off	X			X	X		X		
S	1*	4	0	Off	Off		X		X	X				X
S	1	4	2	Off	On		X	X		X				X
S	1	6D@	0	Off	Off		X		X	X		X		
G, H, Q or V	2	6E@	0	Off	Off	X			X	X			X	
G, H, Q or V	0	6C@	0	Off	Off	X			X		X		X	
G, H, Q or V	0	6C@	2	Off	On	X		X			X		X	
L	0	6C@	2	On	On	X		X			X		X	
V and S	1	6C@	0	Off	Off		X		X		X		X	
L and S	1	6C@	0	On	Off		X		X		X		X	

Definitions:

- L = LonWorks Option Card
- S = Speed Potentiometer
- V = Native Protocol (Modbus)
- G = DeviceNet Option Card
- H = Profibus Option Card
- Q = Ethernet Option Card

- * = The factory default
- # = The H/O/A switch must be in the AUTO position to allow serial com. to control the Drive.
- @ = Jumpers required from S5 to S6

Parameter Reference:

- b1-01: Speed Command Input Source
 - 0: Operator
 - 1: Terminals
- H1-04: Terminal S6 Function Selection
 - 6C: Com/Inv Sel 2
 - 6D: Auto Mode Selection
 - 6E: Hand Mode Selection
 - 4: Multi-Step Ref 2
- H3-08: Terminal A2 Signal Level
 - 0: 0 - 10 VDC
 - 2: 4 - 20 mA

Note: Hand mode run/stop for Drive and Bypass is always via the front control panel HAND/OFF/AUTO switch.

■ Discussion of Table 5.4 Options Dependent, PI Control Bypass Parameter Settings:

Typical Drive Parameter Settings for PI Control with Various Combinations of Bypass and Control Options

Notes:

For project specific PI control tuning see the PI Control (b5-XX) parameters in this chapter. Tables 5.3 and 5.4 provide the basic configuration for PI Control from a Drive in an E7 Bypass unit. The b5-XX parameters are defaulted to a good starting point for most HVAC applications. Final adjustment to some of the b5-XX parameters for the project at hand may be required.

Hand mode run/stop for Drive and Bypass is always via the front control panel HAND/OFF/AUTO switch.

Options - None; Bypass with PI Control and no options:

Hand mode speed command from Keypad/Operator.

Auto mode PI Setpoint from Keypad/Operator.

Auto mode PI Feedback input signal, 4-20 mA applied to Drive terminal A2.

Auto mode run/stop contact closure for Drive and Bypass applied to terminals TB1-3 and TB1-4.

Significant Parameter Setting	Result
b1-01 = 0: Operator	Speed command (Hand) and PI setpoint (Auto) sourced = Keypad/Operator (U1-01)
b5-01 = 1: Enable	Enable PI mode of operation
H1-03 = 19: PI Disable	A terminal S5 input contact closure disables PI mode. This input contact is closed when H/O/A = Hand.
H3-08 = 2: 4-20 mA (default)	Terminal A2 is programmed for 4-20 mA (Note – Control PCB DIP switch S1-2 must also be ON)
H3-09 = B: PI Feedback	Terminal A2 function is set to provide PI feedback for closed loop control
H3-13 = 1: Main Fref TA2	Terminal A2 (the feedback terminal) serves as the main input

Options - None; Bypass with PI Control and no options:

Hand mode speed command from Keypad/Operator.

Auto mode PI Setpoint from Keypad/Operator.

Auto mode PI Feedback input signal, 0-10 VDC applied to Drive terminal A2.

Auto mode run/stop contact closure for Drive and Bypass applied to terminals TB1-3 and TB1-4.

Significant Parameter Setting	Result
b1-01 = 0: Operator	Speed command (Hand) and PI setpoint (Auto) source = Keypad/Operator (U1-01)
b5-01 = 1: Enable	Enable PI mode of operation
H1-03 = 19: PI Disable	A terminal S5 input contact closure disables PI mode. This input contact is closed when H/O/A = Hand.
H3-08 = 0: 0-10 VDC	Terminal A2 is programmed for 0-10 VDC (Note – Control PCB DIP switch S1-2 must also be OFF)
H3-09 = B: PI Feedback	Terminal A2 function is set to provide PI feedback for closed loop control
H3-13 = 1: Main Fref TA2	Terminal A2 (the feedback terminal) serves as the main input

Options - S "Speed Pot.": Bypass with PI Control and speed potentiometer for speed control and setpoint:
 Hand mode speed command from speed potentiometer.
 Auto mode PI Setpoint from speed potentiometer.
 Auto mode PI Feedback input signal, 0-10 VDC applied to Drive terminal A2.
 Auto mode run/stop contact closure for Drive and Bypass applied to terminals TB1-3 and TB1-4.

Significant Parameter Setting	Result
b1-01 = 1: Terminals (default)	Speed command (Hand) and PI setpoint (Auto) source = Terminals
b5-01 = 1: Enable	Enable PI mode of operation
H1-03 = 19: PI Disable	A terminal S5 input contact closure disables PI mode. This input contact is closed when H/O/A = Hand.
H3-08 = 0: 0-10 VDC	Terminal A2 is programmed for 0-10 VDC (Note – Control PCB DIP switch S1-2 must also be OFF)
H3-09 = B: PI Feedback	Terminal A2 function is set to provide PI feedback for closed loop control
H3-13 = 1: Main Fref TA2	Terminal A2 (the feedback terminal) serves as the main input

Options - S "Speed Pot.": Bypass with PI Control and speed potentiometer for speed control:
 Hand mode speed command from speed potentiometer.
 Auto mode PI Setpoint from Keypad/Operator.
 Auto mode PI Feedback input signal, 0-10 VDC applied to Drive terminal A2.
 Auto mode run/stop contact closure for Drive and Bypass applied to terminals TB1-3 and TB1-4.

Significant Parameter Setting	Result
b1-01 = 1: Terminals (default)	Speed command (Hand) and PI setpoint (Auto) source = Terminals
b5-01 = 1: Enable	Enable PI mode of operation
H1-03 = 19: PI Disable	A terminal S5 input contact closure disables PI mode. This input contact is closed when H/O/A = Hand.
H1-04 = 6D: Auto Mode Sel S6 must be jumpered to S5	A terminal S6 input contact opening (H/O/A = Auto) puts the <u>Drive</u> in “Hand” mode to source the PI Setpoint from the Keypad/Operator (overrides b1-01). A terminal S6 input contact closure (H/O/A = Hand) puts the <u>Drive</u> in “Auto” mode to allow b1-01 to determine the speed command source. This input is jumpered to S5, therefore the contact is closed when H/O/A = Hand.
H3-08 = 0: 0-10 VDC	Terminal A2 is programmed for 0-10 VDC (Note – Control PCB DIP switch S1-2 must also be OFF)
H3-09 = B: PI Feedback	Terminal A2 function is set to provide PI feedback for closed loop control
H3-13 = 1: Main Fref TA2	Terminal A2 (the feedback terminal) serves as the main input

Options - G, H, L, Q, or V "Serial Communications"; Bypass with PI Control and serial communication for Setpoint input:
 Hand mode speed command from Keypad/Operator.
 Auto mode PI Setpoint input signal from serial communication.
 Auto mode run/stop contact closure for Drive and Bypass applied to terminals TB1-3 and TB1-4.

Significant Parameter Setting	Result
b1-01 = 2: Serial Com	Speed command (Hand) and PI setpoint (Auto) source = Serial Communication
b5-01 = 1: Enable	Enable PI mode of operation
H1-03 = 19: PI Disable	A terminal S5 input contact closure disables PI mode. This input contact is closed when H/O/A = Hand.
H1-04 = 6E: Hand Mode Sel S6 must be jumpered to S5	A terminal S6 input contact opening (H/O/A = Auto) puts the <u>Drive</u> in "Auto" mode to allow b1-01 to determine the PI Setpoint source. A terminal S6 input contact closure (H/O/A = Hand) puts the <u>Drive</u> in "Hand" mode to source the speed command from the Keypad/Operator (overrides b1-01). This input is jumpered to S5, therefore the contact is closed when H/O/A = Hand.
H3-08 = 0: 0-10 VDC	Terminal A2 is programmed for 0-10 VDC (Note – Control PCB DIP switch S1-2 must also be OFF)
H3-09 = B: PI Feedback	Terminal A2 function is set to provide PI feedback for closed loop control
H3-13 = 1: Main Fref TA2	Terminal A2 (the feedback terminal) serves as the main input

Options - G, H, L, Q, or V "Serial Communications"; Bypass with PI Control and serial communication for run/stop control and Setpoint input:
 Hand mode speed command from Keypad/Operator.
 Auto mode PI Setpoint input signal from serial communication.
 Auto mode run/stop command for Drive from serial communication.
 Auto mode run/stop contact closure for Bypass applied to terminals TB1-3 and TB1-4.

Significant Parameter Setting	Result
b1-01 = 0: Operator	Speed command source = Keypad/Operator (U1-01)
b5-01 = 1: Enable	Enable PI mode of operation
H1-03 = 19: PI Disable	A terminal S5 input contact closure disables PI mode. This input contact is closed when H/O/A = Hand.
H1-04 = 6C: Com/Inv Sel 2 S6 must be jumpered to S5	A terminal S6 input contact opening (H/O/A = Auto) selects serial com for both the run/stop command and speed command. A terminal S6 input contact closure (H/O/A = Hand) allows b1-01 to select Keypad/Operator as the speed command source. This input is jumpered to S5, therefore the contact is closed when H/O/A = Hand.
H3-08 = 2: 4-20 mA (default)	Terminal A2 is programmed for 4-20 mA (Note – Control PCB DIP switch S1-2 must also be ON)
H3-09 = B: PI Feedback	Terminal A2 function is set to provide PI feedback for closed loop control
H3-13 = 1: Main Fref TA2	Terminal A2 (the feedback terminal) serves as the main input

Options - G, H, L, Q, or V and S "Serial Communications" and "Speed Pot."; Bypass with PI Control and serial communication for run/stop control and Setpoint input, with hand mode speed potentiometer:
 Hand mode speed command from speed potentiometer.
 Auto mode PI Setpoint input signal from serial communication.
 Auto mode run/stop command for Drive from serial communication.
 Auto mode run/stop contact closure for Bypass applied to terminals TB1-3 and TB1-4.

Significant Parameter Setting	Result
b1-01 = 1: Terminals (default)	Speed command (Hand) and PI setpoint (Auto) source = Terminals
b5-01 = 1: Enable	Enable PI mode of operation
H1-03 = 19: PI Disable	A terminal S5 input contact closure disables PI mode. This input contact is closed when H/O/A = Hand.
H1-04 = 6C: Com/Inv Sel 2 S6 must be jumpered to S5	A terminal S6 input contact opening (H/O/A = Auto) selects serial com for both the run/stop command and speed command. A terminal S6 input contact closure (H/O/A = Hand) allows b1-01 to select Keypad/Operator as the speed command source. This input is jumpered to S5, therefore the contact is closed when H/O/A = Hand.
H3-08 = 0: 0-10 VDC	Terminal A2 is programmed for 0-10 VDC (Note – Control PCB DIP switch S1-2 must also be OFF)
H3-09 = B: PI Feedback	Terminal A2 function is set to provide PI feedback for closed loop control
H3-13 = 1: Main Fref TA2	Terminal A2 (the feedback terminal) serves as the main input

The analog feedback to the Drive for the PI control is via the A2 terminal. The Drive must be programmed (H3-09= “B: PI Feedback”) to use terminal A2 as feedback for the PI functionality of the Drive.

The PI setpoint can be configured to come from one of many different inputs or parameters. The table below describes the options for originating the PI setpoint.

The PI Setpoint will be read from:	If these conditions are true		
	Status of b5-18	Status of Modbus Register 0Fh bit 1	Status of b1-01
Parameter b5-19	= 1	N/A	N/A
Modbus Register 06H	= 0	ON	N/A
D1-01	= 0	OFF	= 0
Terminal A1	= 0	OFF	= 1
Serial Com.	= 0	OFF	= 2
Option PCB	= 0	OFF	= 3

In some situations there are two feedback inputs. The Drive can be programmed to maintain a set differential between two analog signals. If input A2 is configured as a “PI Differential Mode” (H3-09= “16: PI Differential”), then the Drive will maintain a set difference between the measurements read on inputs A1 and A2. This differential setpoint is programmed by parameter (b5-07).

■ b5-01 PI Mode

Setting	Description
0	Disabled (<i>factory default</i>)
1	Enabled
3	Fref+PI

The Drive can be used as a stand-alone PI controller. If PI functionality is selected by parameter b5-01, the Drive will adjust its output to cause the feedback from a transmitter to match the PI setpoint (b5-19). The setting of b5-01 will determine whether PI functionality is disabled (b5-01= “0: Disabled”), enabled (b5-01= “1: Enabled”), or enable with the output of the PI function used to trim a Speed Command (b5-01= “3: Fref+PI”).

■ b5-02 Proportional Gain Setting

Setting Range: 0.00 to 25.00
 Factory Default: 2.00

The proportional gain will apply a straight multiplier to the calculated difference (error) between the PI Setpoint and the measured transmitter feedback at terminal A2. A large value will tend to reduce the error but may cause instability (oscillations) if too high. A small value may allow to much offset between the setpoint and feedback (See Figure 5.14 on following page).

■ b5-03 Integral Time Setting

Setting Range: 0.0 to 360.0 Seconds
 Factory Default: 5.0 Seconds

The Integral factor of PI functionality is a time-based gain that can be used to eliminate the error (difference between the setpoint and feedback at steady state). The smaller the Integral Time set into b5-03, the more aggressive the Integral factor will be. To turn off the Integral Time, set b5-03= 0.00.

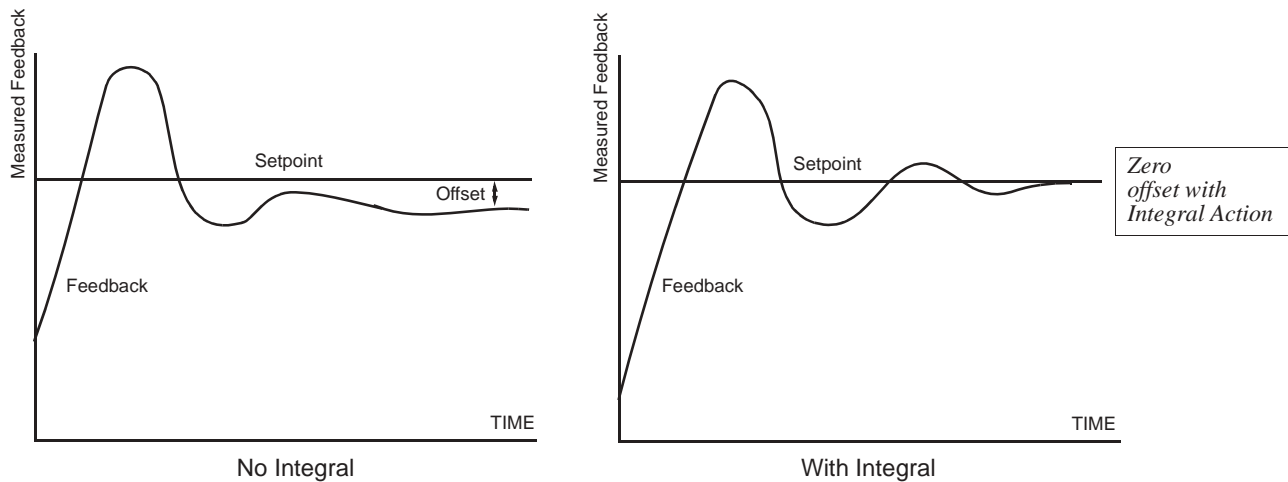

Fig 5.16 PID Feedback Response Characteristics

■ b5-04 Integral Limit Setting

Setting Range: 0.0 to 100.0%

Factory Default: 100.0%

On some applications, especially those with rapidly varying loads, the output of the PI function may have large oscillations. To suppress these oscillations, a limit can be applied to the integral factor by programming b5-04.

■ b5-06 PI Output Limit

Setting Range: 0.0 to 100.0%

Factory Default: 100.0%

Places a cap on the output of the PI function. Limiting the PI function may help to prevent large overshoots in the Drive's response to error (the difference between the setpoint and the feedback).

■ b5-07 PI Offset Adjustment

Setting Range: -100.0% to +100.0%

Factory Default: 0.0%

The PI Offset Adjustment parameter has two different uses. Parameter b5-07 serves different functions depending on whether it is used on a standard PI loop or a Differential PI loop.

Parameter b5-07 causes an offset to be applied to the output of the PI function in a non-differential PI loop. Every time the PI output is updated, the offset (b5-07) is summed with the PI output. This can be used to artificially kick-start a slow starting PI loop.

If the Drive is configured for Differential PI Regulation (H3-09= "16: PI Differential"), then this parameter is the target setpoint for the differential to be maintained between the signal measured on analog input A1 and the signal measured on analog input A2.

■ b5-08 PI Primary Delay Time Constant

Setting Range: 0.00 to 10.00 Seconds

Factory Default: 0.00 Seconds

Acts as a time based filter that lowers the responsiveness of the PI function, but also makes the function more stable when the setpoint varies rapidly or when the feedback is noisy.

■ b5-09 PI Output Level Selection

Setting	Description
0	Normal Output (direct acting) (<i>factory default</i>)
1	Reverse Output (reverse acting)

Normally, the output of the PI function causes an increase in motor speed whenever the measured feedback is below the setpoint. This is referred to as direct acting response. However, if b5-09= “1: Reverse Output”, the output of the PI function causes the motor to slow down when the feedback is below the setpoint. This is referred to as reverse acting response.

■ b5-10 PI Output Gain Setting

Setting Range: 0.0 to 25.0

Factory Default: 1.0

Applies a multiplier to the output of the PI function. Using the gain can be helpful when the PI function is used to trim the Speed Command. Increasing b5-10 causes the PI function to have a greater regulating affect on the speed command.

■ b5-11 PI Reverse Selection

Setting	Description
0	0 Limit (<i>factory default</i>)
1	Reverse

Parameter b5-11 determines whether reverse operation is allowed while using PI control (b5-01≠0). The factory default setting will not allow the Drive to run in reverse. This parameter does not need to be changed from factory default for a majority of HVAC applications. (Refer also to b5-09).

■ b5-12 PI Feedback Reference Missing Detection Selection

Setting	Description
0	Disabled (<i>factory default</i>)
1	Alarm
2	Fault

Loss of feedback can cause problems to a PI application. The Drive can be programmed to turn on a digital output whenever a loss of feedback occurs. Feedback Loss Detection is turned on by b5-12. When b5-12= “1: Alarm”, the Drive acknowledges the loss of feedback without stopping or turning on the fault output (MA-MB). If b5-12= “2: Fault”, the Drive coasts to a stop and turns on the fault output if the feedback is determined to be lost.

■ b5-13 PI Feedback Loss Detection Level

Setting Range: 0 to 100%

Factory Default: 0%

■ b5-14 PI Feedback Loss Detection Time

Setting Range: 0.0 to 25.0 Seconds

Factory Default: 1.0 Seconds

The Drive interprets feedback loss whenever the feedback signal drops below the value of b5-13 and stays below that level for at least the time set into b5-14. See Figure 5.15 below for timing details.

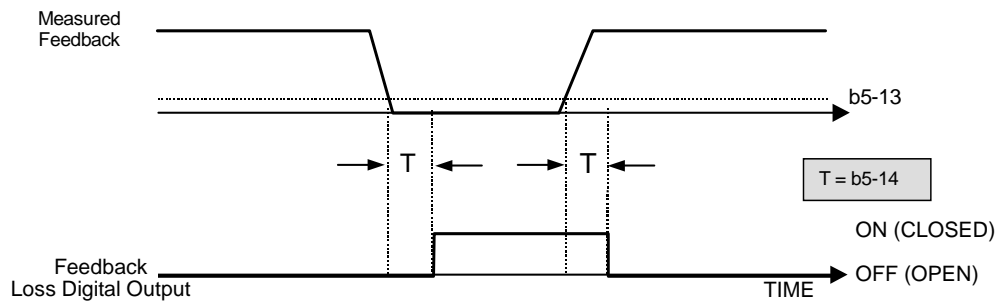

Fig 5.17 Loss of PI Feedback Feature

■ b5-15 Sleep Function Start Level

Setting Range: 0.0 to 200.0 Hz

Factory Default: 0.0 Hz

■ b5-16 Sleep Delay Time

Setting Range: 0.0 to 25.5 Seconds

Factory Default: 0.0 Seconds

The Sleep Function can be programmed to prevent running the Drive when the PI loop output or the speed command is so low that no usable work is being done and/or equipment damage may result. The Sleep Function can be Enabled by entering a value in parameter b5-15. If the Drive's output drops below the level set by the Sleep Function Start Level (b5-15) and remains there at least as long as the delay time determined by the Sleep Delay Time (b5-16), then the Drive's internal Run command drops out and the Drive output ceases. Though the Drive's output has ceased, all other Drive functions continue. Once the Drive's theoretical output returns to a level above the Sleep Function Start Level (b5-15) and remains above that level for at least the Sleep Delay Time (b5-16), the internal Run command returns and the Drive output begins again. The b5-16 Delay Time prevents oscillation about the sleep level. **Note:** The sleep function can be used even if the P1 function is disabled (b5-01 = "0: Disabled").

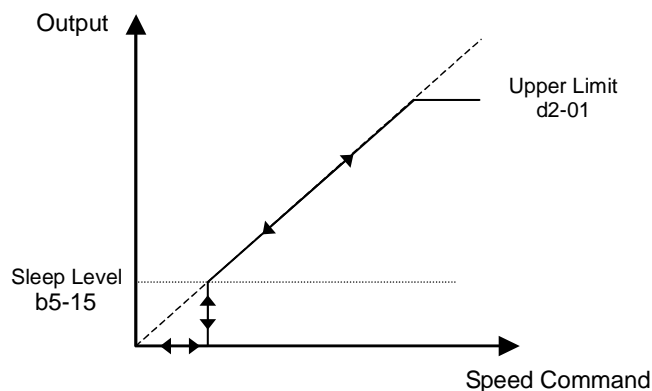

Fig 5.18 Sleep Function Response

■ b5-17 PI Accel/Decel Time

Setting Range: 0.0 to 25.5 Seconds

Factory Default: 0.0 Seconds

This is a soft start function that is applied to the PI setpoint analog input. Instead of having nearly instantaneous changes in signal levels, there is a programmed ramp applied to level changes. When changing setpoints the error can be limited by gradually ramping the setpoint through the use of parameter b5-17.

■ b5-18 PI Setpoint Selection

Setting	Description
0	Disabled (<i>factory default</i>)
1	Enabled

In order to use parameter b5-19 as the PI Setpoint, set parameter b5-18= “1: Enabled”. If b5-18= “0: Disabled” the PI Setpoint will either be:

- Modbus Register 06H (If Register 0FH bit 1 is high)
- The active speed command (i.e. Determined by the setting of b1-01). See Table 1 “Setpoint Options”

■ b5-19 PI Setpoint Value

Setting Range: 0.00 to 100.00%

Factory Default: 0.00%

Parameter b5-19 is for a PI Setpoint value. When b5-18= “1: Enabled”, the value of b5-19 will take precedent over any other PI setpoint unless the Drive is set up for Differential Feedback, in which case, b5-18 and b5-19 have no affect on the PI function.

■ b5-20 PI Setpoint Display Scaling

Setting	Description
0	Hz (<i>factory default</i>)
1	%
3	RPM (Synchronous)
3	Engineering Units

The PI Setpoint Display Scaling value (b5-20) is a scaling factor that is applied to the monitor display for both the PI Setpoint (U1-38) and the PI Feedback (U1-24).

If b5-20 is:	U1-24 and U1-38 Display Increments.
0	0.01 Hz
1	0.00%
2 through 39 (enter the # of motor poles)	0RPM
40 through 39999	Engineering Units

If the monitors seem more natural in terms of percentage, set b5-20= 1. If the monitors are easier to work with when displaying the equivalent synchronous RPM, set b5-20= [the number of motor poles].
 If another engineered unit, such a fpm or cfm, is desired, set b5-20= xxxxx where

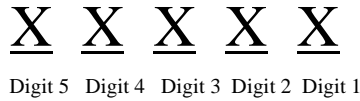

Digits 1 through 4 set the desired number to be displayed at 100% speed.
 Digit 5 determines the number of decimal places

- If Digit 5 = 0 number format is XXXX
- If Digit 5 = 1 number format is XXX.X
- If Digit 5 = 2 number format is XX.XX
- If Digit 5 = 3 number format is X.XXX

For example:

If b5-20= 10425 then at 100% output the digital operator would display 42.5 for monitor U1-38 or U1-24.

■ b5-21 Sleep Source

Setting	Description
0	SFS Input (Output of PI block)
1	PI Setpoint (<i>factory default</i>)
2	Snooze

Parameter b5-21 selects the sleep function characteristic action:

When b5-21= “0: SFS Input” the sleep function start level (b5-15) is compared to the Drive’s output (Speed Command after PI block). This is the setting that should be used for open loop or closed loop control.

It is also possible to have the sleep function start level (b5-15) compared to the Drive input or setpoint. For this special application set b5-21= “1: PI Setpoint”.

When b5-21= “2: Snooze” a variation of the sleep function called “Snooze” is enabled, see parameter b5-22 to b5-27.

IMPORTANT | The sleep function can be used even if the PI function is disabled (b5-01= “0: Disabled”).

■ b5-22 PI Snooze Level

Setting Range: 0 to 100%

Factory Default: 0%

■ b5-23 PI Snooze Delay Time

Setting Range: 0 to 3600 Seconds

Factory Default: 0 Seconds

■ b5-24 PI Snooze Deactivation Level

Setting Range: 0 to 100%

Factory Default: 0%

The Snooze Function is a variation on the Sleep Function. The Snooze function must be selected by setting parameter b5-21= “2: Snooze”. Once the Snooze Function is selected, the Drive monitors the output frequency. If the output frequency drops below the PI Snooze Level (b5-22), and stays below that level for at least the PI Snooze Delay Time (b5-23), the Drive output shuts off. This is different from the Sleep Function because it is the feedback that must drop below the PI Snooze Deactivation Level (b5-24) before normal Drive output will begin again. See Figure 5.19 on the following page.

■ b5-25 PI Setpoint Boost Setting

Setting Range: 0 to 100%

Factory Default: 0%

Just before the Snooze Function is activated, the PI Setpoint can be temporarily increased to create an overshoot of the intended PI Setpoint. The temporary boost is determined by the PI Setpoint Boost Setting (b5-25). Once the temporary boost level is reached (or the PI Maximum Boost Time (b5-26) is exceeded), the Drive output shuts off (snoozes) and the intended PI Setpoint returns. From this point on, the Snooze Function operates normally and the Drive output returns when the feedback level drops below b5-24. See Figure 5.19 on the following page.

■ b5-26 PI Maximum Boost Time

Setting Range: 0 to 3600 Seconds

Factory Default: 0 Seconds

Associated with the Snooze Function. In cases where the temporary PI Setpoint (intended PI setpoint + PI Setpoint Boost) cannot be reached within the PI Maximum Boost Time (b5-26), the Setpoint Boost is interrupted and the Drive output is turned off.

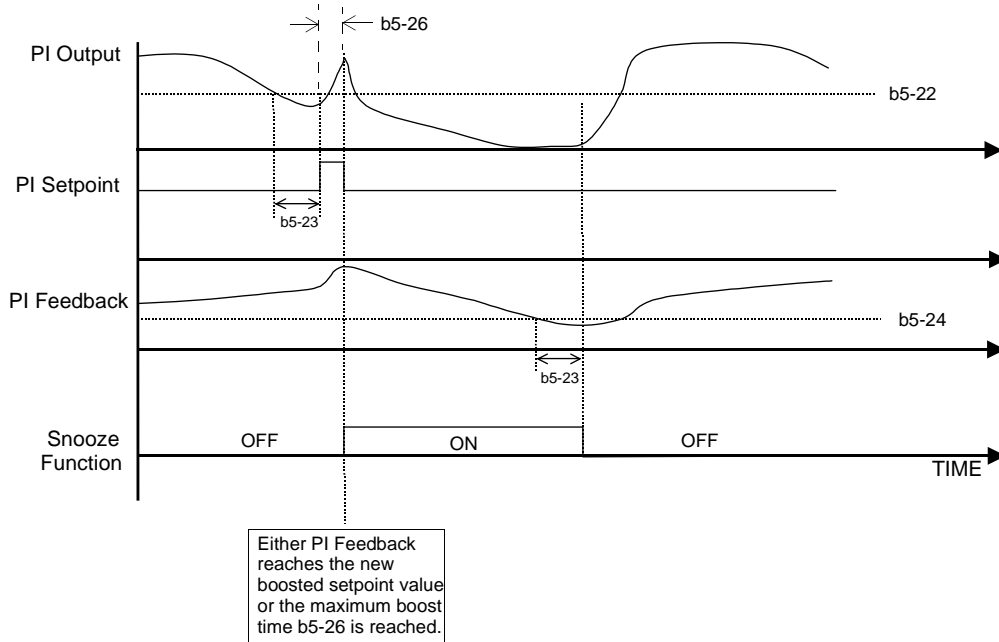

Fig 5.19 Snooze Function Operation

■ b5-27 PI Snooze Feedback Level

Setting Range: 0 to 100%

Factory Default: 60%

This is a second method of initiating the Snooze Function. If the PI feedback level exceeds the PI Snooze Feedback Level (b5-27), then the Drive output shuts off. Once the PI feedback drops below the PI Snooze Deactivation Level (b5-24) then normal Drive and PI operation return.

■ b5-28 PI Feedback Square Root Function Activation

Setting	Description
0	Disabled (<i>factory default</i>)
1	Enabled

If b5-28= "1: Enabled", the square root of the PI feedback is compared to the PI Setpoint in order to determine appropriate Drive output to properly regulate the system. This is helpful in cases where the measured feedback is pressure but the PI loop needs to regulate flow.

■ b5-29 PI Square Root Gain

Setting Range: 0.00 to 2.00

Factory Default: 1.00

A multiplier applied to the square root of the feedback.

■ b5-30 PI Output Square Root Monitor Selection

Setting	Description
0	Disabled (<i>factory default</i>)
1	Enabled

If the PI Function is regulating the flow of a closed loop system by using a pressure feedback, it may be convenient to view the square root of the PI output using monitor U1-37.

◆ b8 Energy Savings

The energy savings function improves overall system operating efficiency by operating the motor at its highest efficiency. This is accomplished by continuously monitoring the motor load and adjusting the motor terminal voltage so that the motor always operates near its rated slip frequency. A motor is most efficient when operating near rated slip conditions.

■ b8-01 Energy Savings Selection

Setting	Description
0	Disabled (<i>factory default</i>)
1	Enabled

When the Energy Savings function is enabled (b8-01= "1: Enabled"), the Drive reduces the output voltage to the motor below the voltage value specified by the programmed V/f pattern whenever the motor load is light. Since torque is reduced during this voltage reduction, the voltage has to return to normal levels when the load returns. The energy savings is realized through improved motor efficiency. The reduced output voltage causes increased rotor slipping even with a light load. A motor is most efficient when operating fully loaded (i.e. operating at rated slip).

■ b8-04 Energy Saving Coefficient Value

Setting Range: 0.0 to 655.0

Factory Default: Model Dependent

Parameter b8-04 is used in maximizing motor efficiency. The factory setting will be Drive capacity dependent but can be adjusted in small amounts while viewing the kW monitor (U1-08) and running the Drive to minimize the output kW. A larger value typically results in less voltage to the motor and less energy consumption. Too large a value will cause the motor to stall.

◆ C1 Accel/Decel

■ C1-01 Acceleration Time 1

C1-02 Deceleration Time 1

C1-03 Acceleration Time 2

C1-04 Deceleration Time 2

Setting Range: 0.0 to 6000.0 Seconds

Factory Default: 30.0 Seconds

C1-01 (Acceleration Time 1) sets the time to accelerate from zero to maximum speed (E1-04). C1-02 (Deceleration Time 1) sets the time to decelerate from maximum speed to zero. C1-01 and C1-02 are the factory default active accel/decel “pair”. Another accel/decel pair (C1-03 and C1-04) exists that can be activated by a multi-function digital input (H1-0x= 7), or specified by a switch over frequency as programmed in parameter C1-11.

Note: In fan applications employing duct high pressure safety limit switches, it may be necessary to further adjust the deceleration time to avoid high pressure limit trips due to damper closure as the system is shut down (an alternate solution in this situation is to set parameter **b1-03** to “Coast to Stop”).

■ C1-09 Fast Stop Time

Setting Range: 0.0 to 6000.0 Seconds

Factory Default: 10.0 Seconds

A special deceleration parameter is available for use with emergency or fault operations. Parameter C1-09 will set a special deceleration that can be operated by closing a digital input configured as H1-0x= 15 or H1-0x= 17. A digital input configured as H1-0x= 15 will look for a switch closure before initiating the Fast Stop operation. A digital input configured as H1-0x= 17 will look for the switch opening before initiating the Fast Stop operation.

Unlike a standard deceleration time, once the Fast Stop operation is initiated even momentarily, the Drive cannot be re-operated until the deceleration is complete, the Fast Stop input is cleared, and the Run command is cycled.

◆ d1 Preset References

- d1-01 Frequency Reference 1
- d1-02 Frequency Reference 2
- d1-03 Frequency Reference 3
- d1-04 Frequency Reference 4

Setting Range: 0.00 to E1-04 Value
 Factory Default: d1-01 = 10.00 Hz
 d1-02 = 6.00 Hz
 d1-03 = 0.00 Hz
 d1-04 = 40.00 Hz

d1-01, d1-02 and d1-04 are special parameter settings required by the Bypass logic circuit. See Table 5.1.

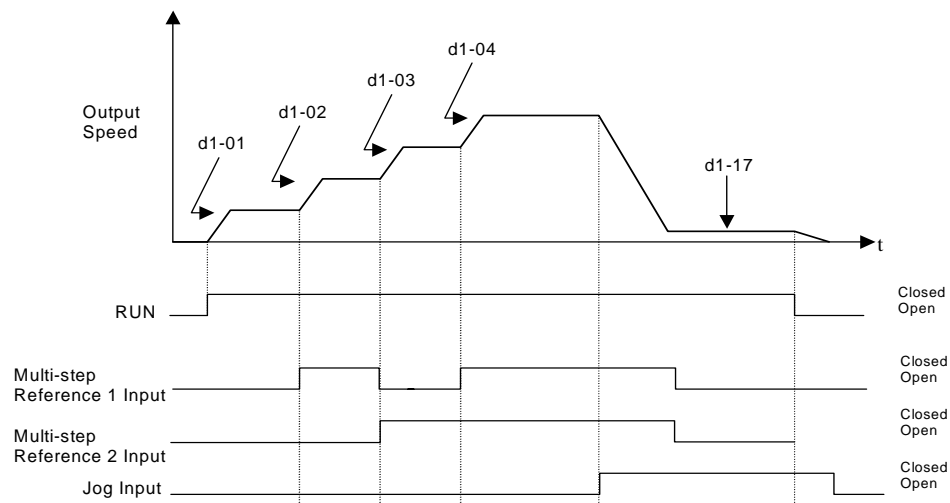

Fig 5.20 Preset Reference Timing Diagram example

■ d1-17 Jog Frequency Reference

Setting Range: 0.00 to E1-04 Value
 Factory Default: 6.00 Hz

The Drive can be programmed to utilize digital inputs to change between four presets speeds and a jog speed. It is a two-step process to set the Drive up for preset speeds. First, d1-01 through d1-04 and d1-17 must be programmed with the desired preset speeds and the desired jog speed, respectively. Next, up to three of the Drive's digital inputs (Terminals S3 through S7) need to be programmed (via parameters H1-01 to H1-05) and wired (to normally open contacts) as Multi-step Speed Reference 1, Multi-step Speed Reference 2, and Jog Frequency.

Table 5.7 Preset Speed Truth Table

Preset Speed	Terminal programmed as Multi-step Reference 1	Terminal programmed as Multi-step Reference 2	Terminal programmed as Jog Reference	Details
1	OFF	OFF	OFF	Frequency Reference 1 (d1-01) or analog input A1
2	ON	OFF	OFF	Frequency Reference 2 (d1-02) or analog input A2
3	OFF	ON	OFF	Frequency Reference 3 (d1-03)
4	ON	ON	OFF	Frequency Reference 4 (d1-04)
5	-	-	ON*	Jog Frequency (d1-17)

* The Jog Frequency input is given priority over the multi-step speeds.

As shown in Table 5.6, it is possible to use analog inputs in place of Frequency Reference 1 and Frequency Reference 2.

- If b1-01= “1: Terminals” then the analog input A1 will be used instead of Frequency Reference 1 for the first preset speed. If b1-01= “0: Operator”, then Frequency Reference 1 will be used.
- If H3-09= “2: Aux Reference” then the analog input A2 will be used instead of Frequency Reference 2 for the second preset speed. If H3-09≠2 then Frequency Reference 2 will be used.

IMPORTANT

The programming of d1-01 through d1-04 and d1-17 will be affected by the setting of o1-03. The programming of these parameters will be in the units specified by Display Scaling parameter (o1-03).

◆ d2 Reference (Speed Command) Limits

■ d2-01 Frequency Reference Upper Limit

Setting Range: 0.0 to 110.0%

Factory Default: 100.0%

■ d2-02 Frequency Reference Lower Limit

Setting Range: 0.0 to 110.0%

Factory Default: 0.0%

The use of parameters d2-01 and d2-02 places limitations on the speed command that the Drive will accept. The parameters are set in units of percentage of the maximum frequency (E1-04) and provide limits on any remote speed command input. By entering upper or lower frequency limits, the Drive programmer can prevent operation of the Drive above or below levels that may cause resonance, equipment damage or discomfort (see also parameter d3-0X). For example, limits may be needed to prevent low speed operation of: cooling tower fans with gear boxes, pumps with pressure dependent seals or AHUs with minimum delivery requirements.

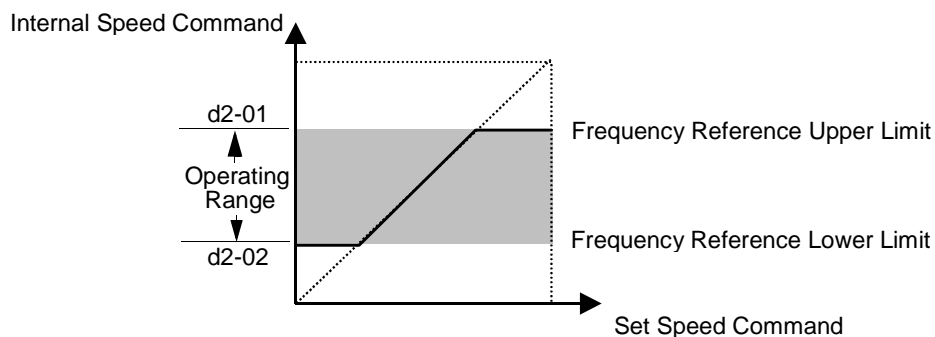

Note: See also the “Sleep” function in Figure 5.19 for alternate “lower limit” implementation.

Fig 5.21 Frequency Reference Upper and Lower Limit Effects on the Speed Command

◆ d3 Jump Frequencies

■ d3-01 Jump Frequency 1

d3-02 Jump Frequency 2

d3-03 Jump Frequency 3

Setting Range: 0.0 to 200.0 Hz

Factory Default: 0.0 Hz

■ d3-04 Jump Frequency Width

Setting Range: 0.0 to 20.0 Hz

Factory Default: 1.0 Hz

In order to avoid continuous operation at a speed that causes resonance in driven machinery, the Drive can be programmed with jump frequencies that will not allow continued operation within specific frequency ranges. If a speed is commanded that falls within a dead band, or Jump Frequency, the Drive will clamp the frequency reference just below the dead band and only accelerate past it when the commanded speed rises above the upper end of the dead band, for increasing references. Similarly, the Drive will clamp the frequency reference just above the dead band and only decelerate past it when the command speed falls below the lower end of the dead band, for decreasing references.

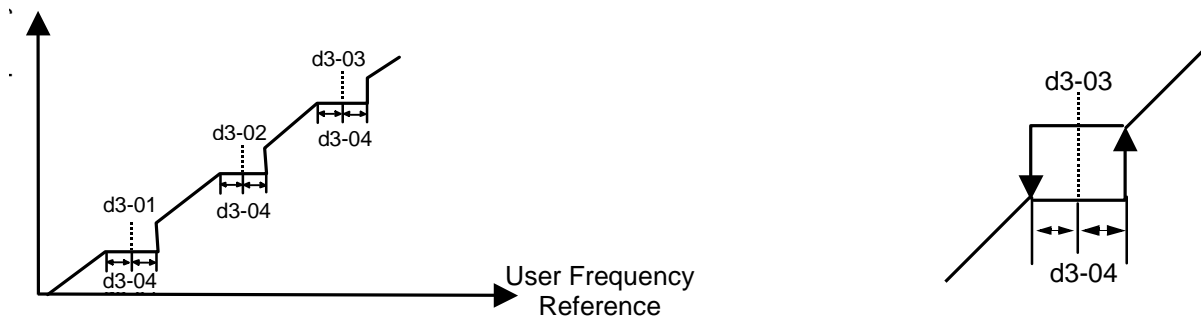

Fig 5.22 Jump Frequency Characteristics

Setting the center point of the dead band with the d3-01 through d3-03 parameters and setting the width of the dead band with parameter d3-04 determines the dead band characteristics. The programmer can set up to three Jump Frequencies. If multiple Jump Frequencies are programmed the following rule applies:

$$d3-01 <= d3-02 <= d3-03$$

◆ d4 Sequence

■ d4-01 MOP Reference Memory

Setting	Description
0	Disabled (<i>factory default</i>)
1	Enabled

The Drive offers the capacity to change the speed command much the way a Motor Operated Potentiometer (MOP) would. Using programmed digital inputs configured as MOP Increase (H1-0x= 10) and MOP Decrease (H1-0x= 11), the Drive will increase the speed command whenever the MOP Increase input is closed and decrease the speed command whenever the MOP Decrease is closed. The speed command will remain constant whenever both inputs are open or closed.

Parameter d4-01 determines whether the last speed command, before the Run command was removed, is remembered even if the power is cycled to the Drive. If d4-01= “0: Disabled”, then when a new Run command is issued the Drive’s speed command will be 0 rpm. If d4-01= “1: Enabled”, then the speed command will be the last commanded speed before the Run command was removed.

◆ E1 V/f Pattern

■ E1-01 Input Voltage Setting

Setting Range: 155.0V to 255.0V (208V/240V Models)
310.0V to 510.0V (480V Models)

Factory Defaults: 208.0V (208V Models)
240.0V (240V Models)
480.0V (480V Models)

Set the Input Voltage parameter (E1-01) to the nominal voltage of the connected AC power supply. This parameter adjusts the levels of some protective features of the Drive (i.e. Overvoltage, Stall Prevention, etc.). E1-01 also serves as the Maximum/Base Voltage used by the Preset V/Hz curves (E1-03= 0 to D).

■ E1-03 V/f Pattern Selection

Setting	Description
0	50 Hz
1	60 Hz Saturation
2	50 Hz Saturation
3	72 Hz
4	50 Hz VT1
5	50 Hz VT2
6	60 Hz VT1
7	60 Hz VT2
8	50 Hz HST1
9	50 Hz HST2
A	60 Hz HST1
B	60 Hz HST2
C	90 Hz
D	120 Hz
F	Custom V/f (<i>factory default, with parameter values per setting 1</i>)
FF	Custom w/o limit

The Drive operates utilizing a set V/f pattern to determine the appropriate output voltage level for each commanded speed. There are 14 different preset V/f patterns to select from with varying voltage profiles, saturation levels (frequency at which maximum voltage is reached), and maximum frequencies.

There are also settings for Custom V/f patterns that will allow the programmer to manually set (“Customize”) the V/f pattern using parameters E1-04 through E1-13.

Using parameter E1-03, the programmer can select one of the preset V/f patterns or chose between a custom V/F pattern with an upper voltage limit (E1-03= “F: Custom V/F”) and a custom V/f pattern without a voltage limit (E1-03= “FF: Custom w/o limit”).

Table 5.8 Preset V/f Patterns								
	Specifications	E1-03	V/f Pattern *1		Specifications	E1-03	V/f Pattern *1	
General-purpose	50Hz	0		High Starting Torque *2	High Starting Torque 1	8		
	60Hz Saturation	1 F			High Starting Torque 2	9		
	50Hz Saturation	2			High Starting Torque 1	A		
					High Starting Torque 2	B		
	72Hz	3			90Hz	C		
Variable Torque	50Hz	Variable Torque 1		High Speed Operation	120Hz	D		
		Variable Torque 2						5
	60Hz	Variable Torque 1	6					
		Variable Torque 2	7					

If one of the custom V/f patterns is selected, then parameters E1-04 through E1-13 will determine the V/F pattern.

IMPORTANT

When a factory Initialization is performed, the setting of E1-03 is unaffected but the settings of E1-04 through E1-13 are returned to their factory default settings.

■ **E1-04 Maximum Output Frequency**

Setting Range: 0.0 to 120.0 Hz

Factory Default: 60.0 Hz

■ E1-05 Maximum Output Voltage

Setting Range: 0.0 to 255.0V (208V/240V Models)
0.0 to 510.0V (480V Models)

Factory Defaults: 208.0V (208V Models)
240.0V (240V Models)
480.0V (480V Models)

■ E1-06 Base Frequency

Setting Range: 0.0 to 200.0 Hz (settings above 120.0 Hz are currently not supported)
Factory Default: 60.0 Hz

■ E1-07 Mid Output Frequency A

Setting Range: 0.0 to 200.0 Hz (settings above 120.0 Hz are currently not supported)
Factory Default: 3.0 Hz

■ E1-08 Mid Output Voltage A

Setting Range: 0.0 to 255.0V (208V/240V Models)
0.0 to 510.0V (480V Models)

Factory Defaults: 18.0V (208V Models)
18.0V (240V Models)
18.0V (480V Models)

■ E1-09 Minimum Output Frequency

Setting Range: 0.0 to 200.0 Hz (settings above 120.0 Hz are currently not supported)
Factory Default: 1.5 Hz

■ E1-10 Mid Output Voltage

Setting Range: 0.0 to 255.0V (208V/240V Models)
0.0 to 510.0V (480V Models)

Factory Defaults: 10.8V (208V Models)
10.8V (240V Models)
10.8V (480V Models)

■ E1-11 Mid Output Frequency B

Setting Range: 0.0 to 200.0 Hz (settings above 120.0 Hz are currently not supported)
Factory Default: 0.0 Hz

■ E1-12 Mid Output Voltage B

E1-13 Base Voltage

Setting Range: 0.0 to 255.0V (208V/240V Models)
0.0 to 510.0V (480V Models)

Factory Defaults: 0.0V (208V Models)
0.0V (240V Models)
0.0V (480V Models)

To set up a custom V/f pattern, program the points shown in the diagram below using parameters E1-04 through E1-13. Be sure that the following condition is true:

$$E1-09 \leq E1-07 \leq E1-06 \leq E1-11 \leq E1-04$$

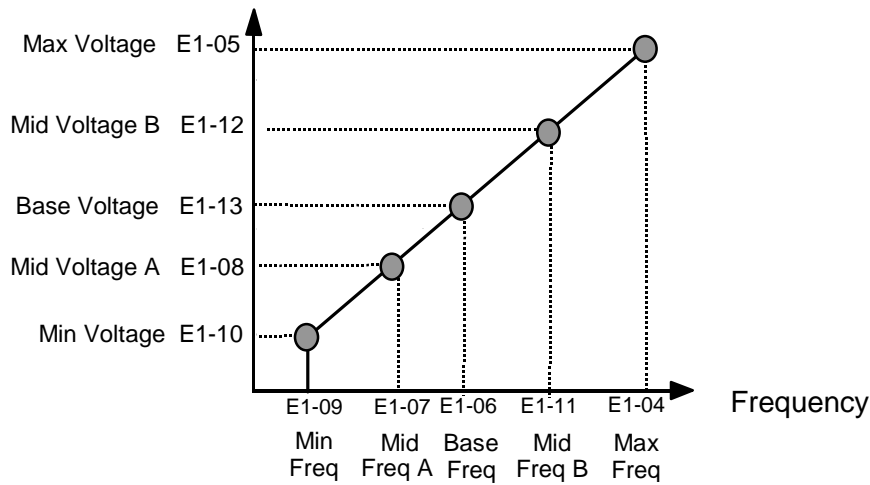

Fig 5.23 Custom V/f Pattern Programming Curve

Increasing the voltage in the V/f pattern increases the available motor torque. However, when setting a custom V/f pattern, increase the voltage gradually while monitoring the motor current, to prevent:

- Drive faults as a result of motor over-excitation
- Motor overheating or excessive vibration

Table 5.8 is for 240V class units only. For 480V class units, multiply the voltage values by 2.

Table 5.9 V/f Pattern Default Settings for Drive Capacity 0.5 to 2 HP for 240V Class										
Parameter No.	Name	Unit	Factory Setting							
E1-03	V/f Pattern Selection	—	0	1	2	3	4	5	6	7
E1-04	Max Output Frequency	Hz	50.0	60.0	60.0	72.0	50.0	50.0	60.0	60.0
E1-05	Max Output Voltage	V	240.0	240.0	240.0	240.0	240.0	240.0	240.0	240.0
E1-06	Base Frequency	Hz	50.0	60.0	50.0	60.0	50.0	50.0	60.0	60.0
E1-07	Mid Output Frequency A	V	2.5	3.0	3.0	3.0	25.0	25.0	30.0	30.0
E1-08	Mid Output Voltage A	V	17.2	17.2	17.2	17.2	40.2	57.5	40.2	57.5
E1-09	Min Output Frequency	Hz	1.3	1.5	1.5	1.5	1.3	1.3	1.5	1.5
E1-10	Mid Output Voltage	V	10.3	10.3	10.3	10.3	9.2	10.3	9.2	10.3
E1-11	Mid Output Frequency B	Hz	0	0	0	0	0	0	0	0
E1-12	Mid Output Voltage B	V	0	0	0	0	0	0	0	0
E1-13	Base Voltage	V	0	0	0	0	0	0	0	0

For 480V class units, the value is twice that of 240V class units.

Table 5.9 V/f Pattern Default Settings for Drive Capacity 0.5 to 2 HP for 240V Class (Continued)										
Parameter No.	Name	Unit	Factory Setting							
E1-03	V/f Pattern Selection	—	8	9	A	B	C	D	E	F
E1-04	Max. Output Frequency	Hz	50.0	50.0	60.0	60.0	90.0	120.0	180.0	60.0
E1-05	Max. Output Voltage	V	240.0	240.0	240.0	240.0	240.0	240.0	240.0	240.0
E1-06	Base Frequency	Hz	50.0	50.0	60.0	60.0	60.0	60.0	60.0	60.0
E1-07	Mid. Output Frequency A	V	2.5	2.5	3.0	3.0	3.0	3.0	3.0	3.0
E1-08	Mid. Output Voltage A	V	21.8	27.6	21.8	27.6	17.2	17.2	17.2	17.2
E1-09	Min. Output Frequency	Hz	1.3	1.3	1.5	1.5	1.5	1.5	1.5	1.5
E1-10	Mid. Output Voltage	V	12.6	14.9	12.6	17.2	10.3	10.3	10.3	10.3
E1-11	Mid Output Frequency B	Hz	0	0	0	0	0	0	0	0
E1-12	Mid Output Voltage B	V	0	0	0	0	0	0	0	0
E1-13	Base Voltage	V	0	0	0	0	0	0	0	0

For 480V class units, the value is twice that of 240V class units.

Table 5.10 V/f Pattern Default Settings for Drive Capacity 3 to 75 HP for 240V Class										
Parameter No.	Name	Unit	Factory Setting							
E1-03	V/f Pattern Selection	—	0	1	2	3	4	5	6	7
E1-04	Max. Output Frequency	Hz	50.0	60.0	60.0	72.0	50.0	50.0	60.0	60.0
E1-05	Max. Output Voltage	V	240.0	240.0	240.0	240.0	240.0	240.0	240.0	240.0
E1-06	Base Frequency	Hz	50.0	60.0	50.0	60.0	50.0	50.0	60.0	60.0
E1-07	Mid. Output Frequency A	V	2.5	3.0	3.0	3.0	25.0	25.0	30.0	30.0
E1-08	Mid. Output Voltage A	V	16.1	16.1	16.1	16.1	40.2	57.5	40.2	57.5
E1-09	Min. Output Frequency	Hz	1.3	1.5	1.5	1.5	1.3	1.3	1.5	1.5
E1-10	Mid. Output Voltage	V	8.0	8.0	8.0	8.0	6.9	8.0	6.9	8.0
E1-11	Mid Output Frequency B	Hz	0	0	0	0	0	0	0	0
E1-12	Mid Output Voltage B	V	0	0	0	0	0	0	0	0
E1-13	Base Voltage	V	0	0	0	0	0	0	0	0

For 480V class units, the value is twice that of 240V class units.

Table 5.10 V/f Pattern Default Settings for Drive Capacity 3 to 40 HP for 240V (Continued)

Parameter No.	Name	Unit	Factory Setting							
			8	9	A	B	C	D	E	F
E1-03	V/f Pattern Selection	—	8	9	A	B	C	D	E	F
E1-04	Max. Output Frequency	Hz	50.0	50.0	60.0	60.0	90.0	120.0	180.0	60.0
E1-05	Max. Output Voltage	V	240.0	240.0	240.0	240.0	240.0	240.0	240.0	240.0
E1-06	Base Frequency	Hz	50.0	50.0	60.0	60.0	60.0	60.0	60.0	60.0
E1-07	Mid. Output Frequency A	V	2.5	2.5	3.0	3.0	3.0	3.0	3.0	3.0
E1-08	Mid. Output Voltage A	V	20.7	26.4	20.7	26.4	16.1	16.1	16.1	16.1
E1-09	Min. Output Frequency	Hz	1.3	1.3	1.5	1.5	1.5	1.5	1.5	1.5
E1-10	Mid. Output Voltage	V	10.3	12.6	10.3	14.9	8.0	8.0	8.0	8.0
E1-11	Mid Output Frequency B	Hz	0	0	0	0	0	0	0	0
E1-12	Mid Output Voltage B	V	0	0	0	0	0	0	0	0
E1-13	Base Voltage	V	0	0	0	0	0	0	0	0

For 480V class units, the value is twice that of 240V class units.

Table 5.11 V/f Pattern Default Settings for Drive Capacity 50 to 150 HP for 230V

Parameter No.	Name	Unit	Factory Setting							
			0	1	2	3	4	5	6	7
E1-03	V/f Pattern Selection	—	0	1	2	3	4	5	6	7
E1-04	Max. Output Frequency	Hz	50.0	60.0	60.0	72.0	50.0	50.0	60.0	60.0
E1-05	Max. Output Voltage	V	240.0	240.0	240.0	240.0	240.0	240.0	240.0	240.0
E1-06	Max. Voltage Frequency	Hz	50.0	60.0	50.0	60.0	50.0	50.0	60.0	60.0
E1-07	Mid. Output Frequency A	V	2.5	3.0	3.0	3.0	25.0	25.0	30.0	30.0
E1-08	Mid. Output Voltage A	V	13.8	13.8	13.8	13.8	40.2	57.5	40.2	57.5
E1-09	Min. Output Frequency	Hz	1.3	1.5	1.5	1.5	1.3	1.3	1.5	1.5
E1-10	Mid. Output Voltage	V	6.9	6.9	6.9	6.9	5.7	6.9	5.7	6.9
E1-11	Mid Output Frequency B	Hz	0	0	0	0	0	0	0	0
E1-12	Mid Output Voltage B	V	0	0	0	0	0	0	0	0
E1-13	Base Voltage	V	0	0	0	0	0	0	0	0

For 480V class units, the value is twice that of 240V class units.

Table 5.11 V/f Pattern Default Settings for Drive Capacity 100 to 150 HP for 230V (Continued)

Parameter No.	Name	Unit	Factory Setting							
			8	9	A	B	C	D	E	F
E1-03	V/f Pattern Selection	–	8	9	A	B	C	D	E	F
E1-04	Max. Output Frequency	Hz	50.0	50.0	60.0	60.0	90.0	120.0	180.0	60.0
E1-05	Max. Output Voltage	V	240.0	240.0	240.0	240.0	240.0	240.0	240.0	240.0
E1-06	Base Frequency	Hz	50.0	50.0	60.0	60.0	60.0	60.0	60.0	60.0
E1-07	Mid. Output Frequency A	V	2.5	2.5	3.0	3.0	3.0	3.0	3.0	3.0
E1-08	Mid. Output Voltage A	V	17.2	23.0	17.2	23.0	13.8	13.8	13.8	13.8
E1-09	Min. Output Frequency	Hz	1.3	1.3	1.5	1.5	1.5	1.5	1.5	1.5
E1-10	Mid. Output Voltage	V	8.0	10.3	8.0	12.6	6.9	6.9	6.9	6.9
E1-11	Mid Output Frequency B	Hz	0	0	0	0	0	0	0	0
E1-12	Mid Output Voltage B	V	0	0	0	0	0	0	0	0
E1-13	Base Voltage	V	0	0	0	0	0	0	0	0

For 480V class units, the value is twice that of 240V class units.

◆ E2 Motor Setup

■ E2-01 Motor Rated Current

Setting Range: Model Dependent (see appendix B)

Factory Default: Model Dependent

The Motor Rated Current parameter (E2-01) is necessary information for the Drive motor protection function. The motor overload protection parameter L1-01 is enabled by default. In addition, motor rated current is used by the torque compensation function to insure optimum torque production. Set E2-01 to the full load amps (FLA) value stamped on the motor's nameplate. During Auto-tuning, it is required for the operator to enter the motor rated current in parameter T1-04 on the Auto-Tuning menu. If the Auto-tuning operation completes successfully, the value entered into T1-04 will be also written into E2-01.

For applications employing a Drive that is oversized for the motor, E2-01 may be set as low as 10% of the Drive output current rating. The ampere value in E2-01 however, must always be greater than the "No Load Current" value in parameter E2-03 or an OPE02 error will be displayed.

■ E2-03 No Load Current

Setting Range: Model Dependent (see appendix B)

Factory Default: Model Dependent

Set E2-03 to the motor no-load current at rated voltage and rated frequency. Consult the motor manufacturer for the proper value if the no load current is not stated on the motor nameplate.

◆ F6 Com OPT Setup

(Applies only to the LonWorks® option)

■ F6-01 Operation Selection After Communication Error

Setting	Description
0	Ramp to Stop
1	Coast to Stop
2	Fast-Stop
3	Alarm Only (<i>factory default</i>)

If a serial communication option board is attached to the Drive at the 2CN connector, the Drive will automatically monitor the card for any type of communication errors. F6-01 is applicable no matter whether a run command or speed command is coming via the option board, digital operator, or terminal input. The setting of F6-01 determines whether the communication error is seen as a fault or an alarm. If F6-01= “3: Alarm Only”, then the fault output is not energized upon a communication error. All other settings of F6-01 cause the fault output to energize. The setting of F6-01 does not apply to any of the embedded communication protocols used at the RS-485/422 terminals on the removable terminal board. (See parameters H5-0X)

■ F6-02 Option PCB External Fault Detection Selection

Setting	Description
0	Always Detected (<i>factory default</i>)
1	Detected only during operation

■ F6-03 Option PCB External Fault Stopping Method

Setting	Description
0	Ramp to Stop
1	Coast to Stop (<i>factory default</i>)
2	Fast-Stop
3	Alarm Only

If an external fault is received from the LonWorks® or other communication option card, the settings of F6-02 and F6-03 will determine the Drive operation in reaction to the fault signal. Parameter F6-02 will determine if the external fault is always recognized (F6-02= “0: Always Detected”) or only recognized when the Run command is active (F6-02= “1: Detected only during operation”).

Once the fault is recognized, parameter F6-03 will determine the operation of the Drive. If parameter F6-03 is set to anything other than “3”, the Drive will fault and a stopping sequence is begun. If F6-03= “3: Alarm Only”, then the external fault is treated like an alarm. Operation will continue and an EF0 fault will flash on the digital operator.

■ F6-05 Current Scaling via Communication Option PCB

Setting	Description
0	A Display (<i>factory default</i>)
1	100%/8192 (Drive Rated Current)

A communication option card can read the Drive's DPRAM to access the current monitor. The format of the current reading in the DPRAM will be determined by parameter F6-05.

F6-05= "0: A Display" → Current is a decimal number corresponding to actual Amperes
F6-05= "1: 100%/8192 (Drive Rated Current)" → Current reading is a number where
8192 = 100% of Drive rated output current

◆ H1 Digital Inputs

■ H1-01 Terminal S3 Function Selection

H1-02 Terminal S4 Function Selection

H1-03 Terminal S5 Function Selection

H1-04 Terminal S6 Function Selection

H1-05 Terminal S7 Function Selection

Setting Range: 0 to 6E

Factory Default: H1-01= "70: Bypass Drv Envl" This is one of the special parameter settings required by the Bypass logic circuit. See Table 5.1.

H1-02= This is one of the special parameter settings required by the Bypass logic circuit. See Table 5.2

H1-03= This is one of the special parameter settings required by the Bypass logic circuit. See Table 5.2.

H1-04= "4: Multi-Step Ref 2" (2 Wire)

"3: Multi-Step Ref 1" (3 Wire)

H1-05= "6: Jog Freq Ref " (2 Wire)

"4: Multi-Step Ref 2" (3 Wire)

The Drive has five multi-function contact digital inputs. By programming parameters H1-01 through H1-05, the user can assign specific functions to each input. Below is a table with a complete list of all of the digital input functions. The programming manual has a more detailed description of each of the functions.

Parameter setting	Function	Parameter setting	Function
0	3-Wire Control	1C	Trim Control Increase
1	Local/Remote Selection	1D	Trim Control Decrease
2	Option/Inv Selection 1	1E	Reference Sample Hold
3	Multi-step Reference 1	20-2F	External Fault
4	Multi-step Reference 2	30	Integral Reset
6	Jog Frequency Reference 1	31	Integral Hold
7	Multi-Accel/Decel 1	34	PI Soft Start Cancel
8	External Baseblock N.O.	35	PI Input Characteristic
9	External Baseblock N.C.	36	Option/Inv Selection 2
A	Accel/Decel Ramp Hold	60	Motor Pre-heat
C	Terminal A2 Enable	61	Speed Search 1
F	Terminal Not Used	62	Speed Search 2
10	MOP Increase	64	Speed Search 3
11	MOP Decrease	67	Communications Test Mode
12	Forward Jog	68	High Slip Braking
13	Reverse Jog	69	Jog Frequency Reference 2
14	Fault Reset	6A	Drive Enable (Cycle Run)
15	Fast Stop N.O.	6B	Com/Inv Selection
17	Fast Stop N.C.	6C	Com/Inv SEL 2
18	Timer Function	6D	Auto Mode @ Close
19	PI Disable	6E	Hand Mode @ Close
1B	Program Lockout	70	Drive Enable (Accept Run)

Following are descriptions of only those parameters that are required for Bypass operations and PI control.

■ **Function: Multi-step Ref 1**

Setting: 3

■ **Function: Multi-step Ref 2**

Setting: 4

The Drive can be programmed to step through four preset speeds and a jog. It is also possible to mix in the analog inputs as speed references that can be chosen in place of the first and second preset frequency references. The selection of which preset speed will be the active speed command is determined by the status of the digital inputs set for Multi-step Ref 1 (H1-0x= 3) and Multi-step Ref 2 (H1-0x= 4). Changing the active speed command via the Multi-step References can be done while the Drive is running.

The following table details which reference is active based on the status of the Multi-step Ref 1 and Multi-step Ref 2 inputs:

Table 5.13 Digital Input Functions				
Preset Speed	Terminal Programmed as Multi-step Reference 1	Terminal Programmed as Multi-step Reference 2	Terminal Programmed as Jog Reference	Details
1	OFF	OFF	OFF	Frequency Reference 1 (d1-01) or analog input A1
2	ON	OFF	OFF	Frequency Reference 2 (d1-02) or analog input A2
3	OFF	ON	OFF	Frequency Reference 3 (d1-03)
4	ON	ON	OFF	Frequency Reference 4 (d1-04)
5	-	-	ON*	Jog Frequency (d1-17)

* The Jog Frequency input is given priority over the multi-step speeds.

The determination of whether the Preset Speed 1 will be the Frequency Reference 1 (d1-01 or the analog input A1) is determined by the status of b1-01. If b1-01= “1: Terminals”, the value of the input to A1 will determine the commanded speed when Preset Speed 1 is selected. If b1-01≠1, the setting of d1-01 will determine the commanded speed when Preset Speed 1 is selected.

The determination of Preset Speed 2 is made much the same way as Preset Speed 1 except that the setting of parameter H3-09 decides whether the analog input A2 or d1-02 is Preset Speed 2. If H3-09= “2: Aux Reference”, the value of the input to A2 will determine the commanded speed when Preset Speed 2 is selected. If H3-09≠2, the setting of d1-02 will determine the commanded speed when Preset Speed 2 is selected.

■ Function: Fault Reset

Setting: 14

Whenever the Drive detects a fault condition, the fault output contact will close and the Drive’s output will shut OFF causing the motor to coast (specific stopping methods can be selected for some faults such as L1-04 for motor overheat). Once the Run command is removed, the fault can be reset by either the RESET key on the digital operator or by closing a digital input configured as a Fault Reset (H1-0x= 14).

■ Function: PI Disable

Setting: 19

When the PI Function has been enabled by b5-01 (PI Mode Selection), it can be indefinitely disabled by closing a digital input configured as a PI Disable input (H1-0x= 19). When disabled, the Drive operates as a standard Drive that does not have PI enabled.

■ Function: Com/Inv Sel 2

Setting: 6C

The Com/Inv Selection function allows the user to switch the origin of the Run and speed command between the Drive’s terminals and the RS-485/422 port (and the embedded communication protocols) on the removable terminal board. When a digital input is programmed for the Com/Inv Selection function (H1-0x= 6B) that input will function as follows:

Table 5.14	
Option/Inv Function Input Status	Run and Speed Command Source
OPEN	From the control circuit and analog input terminals
CLOSED	From Serial Com port (R+,R-,S+, and S-) (embedded protocols)

To switch the command source between the serial communication port and the control circuit terminals be sure to program the following parameters:

- Set b1-01 (Frequency Reference Selection) to 1 (Terminals).
- Set b1-02 (Run Command Selection) to 1 (Terminals).
- Set H1-0x (Input Terminal Function Selection) to 6B or 6C.

The Com/Inv Sel 2 function will operate the same way except the logic is reversed. When a digital input is programmed for the Com/Inv Selection function (H1-0x= 6C) that input will function as follows:

Table 5.15	
Option/Inv Function Input Status	Run and Speed Command Source
OPEN	From Serial Com port (R+, R-, S+, and S-) (embedded protocols)
CLOSED	From the control circuit and analog input terminals

IMPORTANT

Switching the Reference and Run sources can only be done while the Drive is stopped.

■ **Function: Auto Mode Sel**

Setting: 6D

■ **Function: Hand Mode Sel**

Setting: 6E

This effects the speed command (reference) input only. The Auto Mode Selection (H1-0x= 6D) and the Hand Mode Selection (H1-0x= 6E) allows use of a digital input to toggle between the Auto and Hand operational modes for speed control. The Auto Mode Selection and Hand Mode Selection cannot both be programmed simultaneously. If both 6D and 6E are programmed together, an OPE03 fault will occur.

The 6D setting for digital input defines the speed command (or setpoint) source as the keypad/operator for an open contact and allows b1-01 to determine the speed command source for a closed contact. Setting 6D has no effect on the run command.

Input Contact Status	Speed Command or PI Setpoint Source
OPEN	Keypad/operator (override b1-01)
CLOSED	Determined by b1-01

The 6E setting for digital input defines the speed command (or setpoint) source as the keypad/operator for an closed contact and allows b1-01 to determine the speed command source for a open contact.

Input Contact Status	Speed Command or PI Setpoint Source
OPEN	Determined by b1-01
CLOSED	Keypad/operator (overrides b1-01)

◆ H2 Digital Outputs

■ H2-01 Terminal M1-M2 Function Selection

H2-02 Terminal M3-M4 Function Selection

Setting Range: 0 to 3B

Factory Default: H2-01= “0: During Run 1”

H2-02= “3B: Run Src Com/Opt”

H2-02 is one of the special parameter settings required by the Bypass logic circuit. See Table 5.1.

The Drive has two multi-function outputs. By programming parameters H2-01 and H2-02, the user can assign specific functions to each output. Below is a table with a complete list of all of the digital output functions. Refer to the Programming Manual for a more detailed description of each of the functions.

Parameter setting	Function	Parameter Setting	Function
0	During Run 1	F	Terminal Not Used
1	Zero Speed	10	Minor Fault
2	F _{REF} /F _{OUT} Agree 1	11	Reset Cmd Active
3	F _{REF} /Set Agree 1	12	Timer Output
4	Frequency Detect 1	17	Torque Detect 1 N.C.
5	Frequency Detect 2	1A	Reverse Direction
6	Drive Ready	1E	Restart Enabled
7	DC Bus Undervoltage	1F	Overload (OL1)
8	Baseblock 1	20	OH Pre-alarm
9	Option Reference	38	Drive Enable
A	Remote Operation	39	Drive Waiting
B	Torque Detect 1 N.O.	3A	Frequency Reduced, OH
C	Loss of Reference	3B	Run from Serial Com
E	Fault		

◆ H3 Analog Inputs

■ H3-02 Terminal A1 Gain Setting

Setting Range: 0.0 to 1000.0%

Factory Default: 100.0%

H3-02 is one of the special parameter settings required by the Bypass logic circuit, depending on the options provided. See Table 5.2.

The addition of another input signal on terminal A1 to the Drive and Bypass unit, after shipment to the job site, would be the only reason for changing this parameter.

For example, in variable air volume AHUs with a “volume matching” control strategy, P1 differential control is employed with feedback signals connected to both terminals A1 and A2.

■ H3-03 Terminal A1 Bias Setting

Setting Range: -100.0% to +100.0%

Factory Default: 0.0%

In order to have the Drive properly interpret an analog input, it may be necessary to apply a gain and/or a bias to the signal. The analog inputs have a resolution of 10 bits (1024 steps). Using the factory default settings for the analog input's gain and bias, the 0-10Vdc or 4-20mA signal at the analog input will yield a 0-100% speed command span.

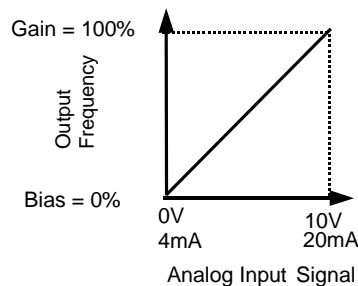

Fig 5.24 Output Frequency as Commanded Via Analog Input

If a different span of analog input signal is desirable, it will be necessary to adjust the gain, the bias, or both to allow the analog input level to generate the desired frequency command. Adjustment of the gain setting will change the speed command that is equivalent to the maximum analog input (10Vdc or 20mA). If, for instance, the gain is increased to 200%, then 10Vdc or 20mA will be equivalent to a 200% speed command and 5 VAC or 12mA will be equivalent to a 100% Speed Command. Since the Drive output is limited by the maximum frequency parameter (E1-04), 0-5Vdc or 4-12mA will now be equivalent to 0-100% speed command span.

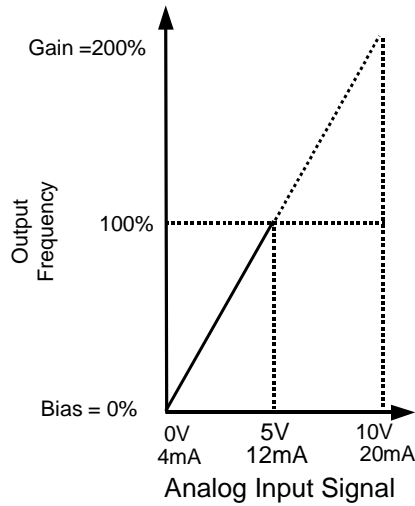

Fig 5.25 Output Frequency as Commanded via Analog Input with Increased Gain Setting

Adjustment of the bias setting will likewise adjust the speed command that is equivalent to the minimum analog input level (0Vdc or 4mA). If, for instance, the bias is set to -25% , then 0Vdc or 4mA will be equivalent to a -25% speed command. Since the minimum speed command is 0% an analog input of 2.5 to 10Vdc or 8 to 20mA will now be equivalent to 0-100% speed command span.

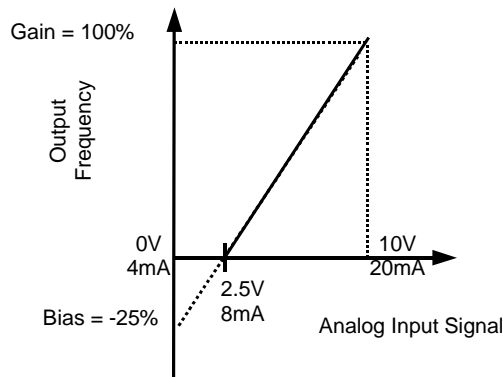

Fig 5.26 Output Frequency with Reduced Bias Setting

As a further example, for an inverse-acting speed command, set the bias= 100% and the gain= 0%. The minimum analog input level (0Vdc or 4mA) will produce a 100% speed command and the maximum analog input level (10Vdc or 20mA) will produce a 0% speed command.

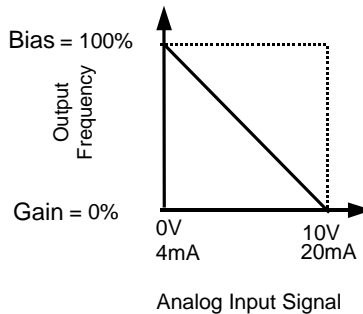

Fig 5.27 Output Frequency with Inverted Gain and Bias Settings

■ H3-08 Terminal A2 Signal Level

Setting	Description
0	0 - 10VDC
2	4 - 20mA (Default)

H3-08 is one of the special parameter settings required by the Bypass logic circuit. See Table 5.2.

The H3-08 parameter (Terminal A2 Signal Level) allows the programmer to specify the signal that will be applied to the A2 analog input. The A2 analog input can accept either a 0–10 Vdc or 4–20 mA signal as a reference. The Drive also has a DIP switch (S1) on the removable terminal board that must be set for the proper reference signal into the A2 analog input. The S1-2 dipswitch setting determines the internal resistance of the A2 input while parameter H3-08 determines how the Drive interprets the measured signal.

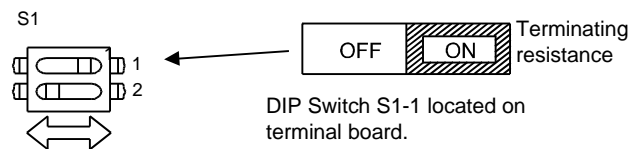
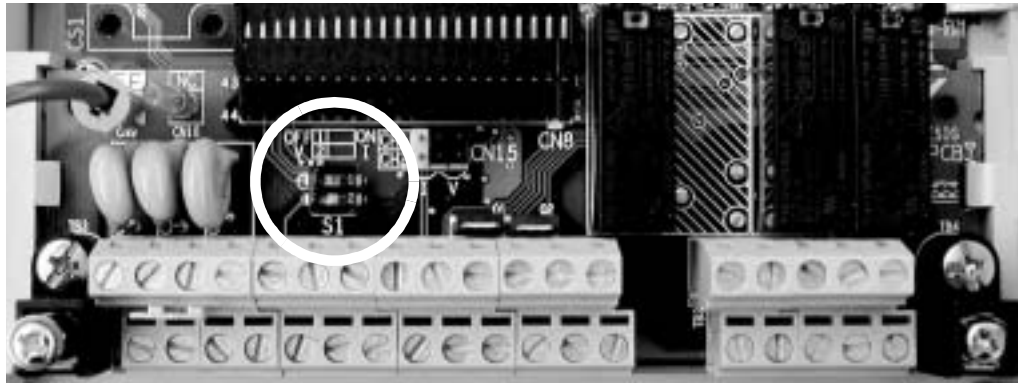

Fig 5.28 DIP Switch S1

Name	Function	Setting
S1-1	RS-485 and RS-422 terminating resistance	OFF: No terminating resistance (Factory default) ON: Terminating resistance of 110 Ω
S1-2	Input method for analog input A2	OFF: 0 to 10 V (internal resistance: 20 kΩ) ON: 4 to 20 mA (internal resistance: 250 Ω) (Factory default)

■ H3-09 Terminal A2 Function Selection

H3-09 is one of the special parameter settings required by the Bypass logic circuit. See Table 5.2.

Setting	Description
0	Frequency Bias
2	Aux Reference
B	PI Feedback
D	Frequency Bias 2
E	Motor Temperature
16	PI Differential
1F	Not Used

The A2 analog input can be programmed to perform many different functions. The setting of parameter H3-09 determines which of the following functions the A2 analog input will perform.

Function: Aux Reference

Setting: 2

In order for the A2 analog input to be used as the master Speed Command, parameter H3-09 must be set for Aux Reference (H3-09= “2: Aux Reference”). Once A2 is configured as an auxiliary reference, it can be selected as the master Speed Command by setting H3-13= “1: Main Fref TA2”. If H3-09= 2, terminal A2 analog input will become the speed command when a digital input programmed for Multi-Step Ref 1 (H1-0x= 3) is selected by a contact closure.

Function: PI Feedback

Setting: B

Configuring the A2 analog input as PI Feedback (H3-09= “B: PI Feedback”) is a requirement of setting the Drive up for PI operation. The A2 analog input is the only source for feedback for PI operation though the setpoint can come from a number of different sources (refer to the section covering the PI parameters for more information regarding specifying the setpoint source. PI parameters are listed in section b5).

Parameters H3-10 (Terminal A2 Gain) and H3-11 (Terminal A2 Bias) can be used to configure the A2 analog input to match the signal from the Feedback Transmitter.

The U1-24 monitor (PI Feedback) can be used to check the PI Feedback level with the digital operator.

Function: PI Differential

Setting: 16

Normal PI operation will adjust the Drive output in order to match the measured feedback value to a desired setpoint. When PI is operated in the differential mode, however, the Drive output is adjusted in order to maintain a desired differential between two feedback signals.

When the A2 analog input is configured as a PI Differential (H3-09= “16: PI Differential”), the A1 analog input becomes the other PI Differential input. The desired differential is set by parameter b5-07 (PI Differential Setpoint) and can be set so that A2 is held less than A1 (b5-07 <0) or A2 is held greater than A1 (b5-07 >0).

When PI Differential operation is chosen, the A1 feedback level can be monitored by U1-24 (PI Feedback) and the A2 feedback level can be monitored by U1-53 (PI Feedback2).

■ H3-10 Terminal A2 Gain Setting

Setting Range: 0.0 to 1000.0%

Factory Default: 100.0%

■ H3-11 Terminal A2 Bias Setting

Setting Range: -100.0% to +100.0%

Factory Default: 0.0%

Parameters H3-10 and H3-11 perform the same function for the A2 analog input that parameters H3-02 and H3-03 perform for the A1 analog input. Please refer to the parameter description for H3-02 and H3-03 for information about H3-10 and H3-11.

These parameters could be used for final calibration of a factory or field installed pressure to electric transducer input connected to terminal A2 and AC. This field calibration may be needed if there is a job site variation from the typical 3 to 15 PSIG pneumatic signal input range.

■ H3-12 Analog Input Filter Time Constant

Setting Range: 0.0 to 2.00 Seconds

Factory Default: 0.30 Seconds

An analog input filter can be used to prevent erratic Drive control when a “noisy” analog reference is used. Parameter H3-12 sets the time constant for a first order filter that will be applied to both the A1 and A2 analog inputs. The Drive operation becomes more stable the longer the time programmed, but it becomes less responsive to rapidly changing analog signals.

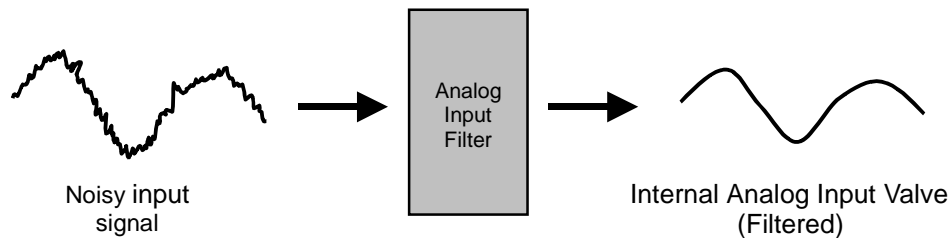

Fig 5.29 Analog Input Filter Time Constant Effect on “Noisy” Signal

■ H3-13 Master Frequency Reference Terminal Selection

Setting	Description
0	Main Fref= A1 (<i>factory default</i>)
1	Main Fref= A2

H3-13 is one of the special parameter settings required by the Bypass logic circuit. See Table 5.2.

Parameter H3-13 allows the programmer to select which analog input will serve as the Speed Command input when “Terminals” are selected as the Auto Mode Speed source (b1-01= “1: Terminals”), or Terminal is selected as the reference source for the Hand mode (b1-12= “1: Terminals”). For the A2 analog input to be an effective selection for the H3-13 parameter, parameter H3-09 must be configured as Aux Reference (H3-09= “2: Aux Reference”).

If H3-09≠2, then the A1 analog input will be used regardless of the setting of parameter b1-12.

◆ L2 Momentary Power Loss Ride-thru Function

When momentary power loss recovery is enabled (L2-01≠0), a speed search is executed to catch the potentially spinning motor shaft. This speed search will occur regardless of the setting of b3-01 “Speed Search Selection”.

■ L2-01 Momentary Power Loss Detection Selection

Setting	Description
0	Disabled
1	PwrL Ride Thru t
2	CPU Power Active (<i>factory default</i>)

■ L2-02 Momentary Power Loss Ride-Thru Time

Setting Range: 0.0 to 25.5 Seconds

Factory Default: Model Dependent

The Drive allows different responses to momentary power losses. The setting of L2-01 determines whether the Drive attempts to restart after a short loss of incoming AC power and for what length of time this capability remains active.

If L2-01= “0: Disabled”, the Drive detects a UV1 fault 15ms after power loss and automatic restarting is disabled. The Drive cannot restart until the external run command is removed and the UV1 fault is reset.

If L2-01= “1: PwrL Ride Thru t”, the Drive restarts without the UV1 fault if power is returned within the time specified in L2-02, the Momentary Power Loss Ride-thru Time. During the power loss but before the fault trip, the digital operator will display a UV alarm. If L2-02 is set for a time longer than the control power supply can be sustained, a UV1 fault will not occur and the Drive restarts upon the return of AC power. The time that the control power supply can be maintained varies with Drive size. The larger the Drive, the greater the potential ride-thru time.

If L2-01= “2: CPU Power Active”, the Drive ignores L2-02 and attempts a restart as long as the control power supply is still able to maintain a minimal voltage level. In effect, setting L2-01= “2: CPU Power Active” (factory default) is programming the Drive for maximum Power Loss Ride-thru. An equivalent setting is L2-01= “1: PwrL Ride Thru t”, with L2-02 set to a time longer than the control power supply can be maintained after power is lost.

Note: The run command must be held during power loss for any power loss ride-thru capability to be possible. It is for this reason that 3-wire control is not recommended for use with the Momentary Power Loss function.

◆ L3 Stall Prevention

■ L3-01 Stall Prevention Selection During Accel

Setting	Description
0	Disabled
1	General Purpose (<i>factory default</i>)
2	Intelligent

■ L3-02 Stall Prevention Level During Accel

Setting Range: 0 to 200% of Drive rated output current

Factory Default: 120% of Drive rated output current

The stall prevention during acceleration function adjusts the acceleration time in order to prevent OC fault trips during acceleration. If L3-01= “0: Disabled”, stall prevention is disabled. If the load is large enough and the acceleration time short enough the Drive may fault and stop.

If L3-01= “1: General Purpose”, then the standard stall prevention function is enabled. When the output current exceeds the level set by the L3-02 parameter, the Drive will discontinue accelerating and maintain speed. If, during acceleration, the output current comes within 15% of the level set by parameter L3-02, the acceleration time is lengthened. Once the output current level has dropped below the L3-02 level, acceleration will begin again with the acceleration rate reaching the programmed rate once again 15% below the L3-02 level.

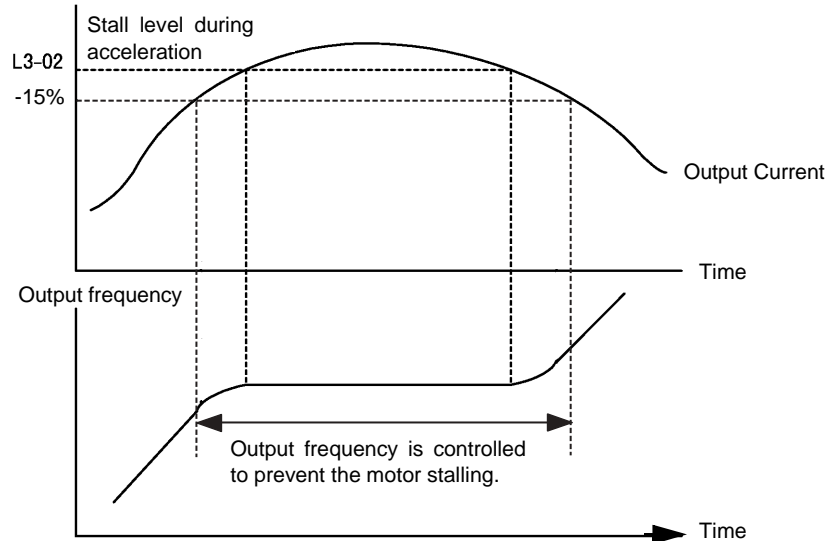

Fig 5.30 Detailed Time Chart for Stall Prevention During Acceleration

If L3-01= “2: Intelligent”, the intelligent stall prevention is enabled. The active acceleration time is ignored and the Drive will attempt to accelerate as quickly as possible without exceeding the L3-02 output current level.

IMPORTANT

Stall Prevention during Acceleration is not effective when the output frequency is less than 6Hz.

The following figure demonstrates acceleration when L3-01= “1: General Purpose”.

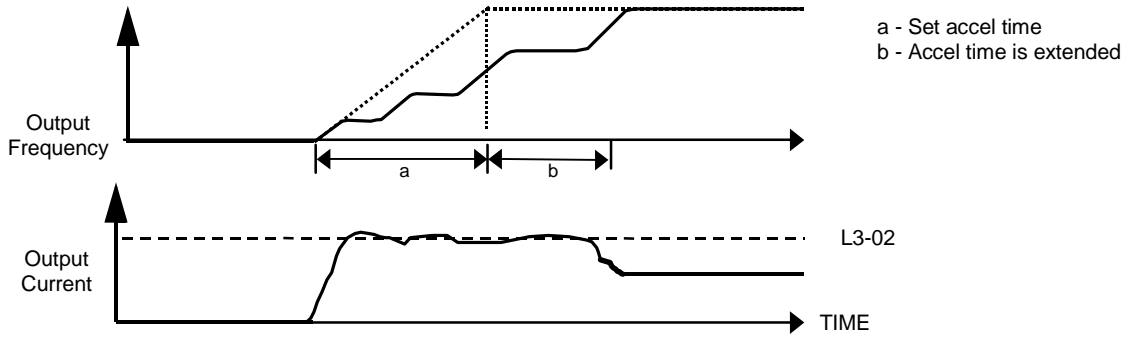

Fig 5.31 Time Chart for Stall Prevention During Acceleration

The L3-02 parameter is set as a percentage of the Drive rated output current. If the motor capacity is small compared to the Drive’s capacity, or if the motor stalls during acceleration, lower the set value of L3-02.

■ L3-04 Stall Prevention Selection During Decel

Setting	Description
0	Disabled
1	General Purpose (<i>factory default</i>)
2	Intelligent
3	Stall prev w/R

The stall prevention during deceleration function adjusts the deceleration time in order to prevent OV fault trips during deceleration. If L3-04= “0: Disabled”, stall prevention is disabled and if the load is large and the deceleration time short enough the Drive may fault and stop.

If L3-04= “1: General Purpose”, then the standard stall prevention function is enabled. If, during deceleration, the DC Bus voltage exceeds the stall prevention level (see table below), the Drive will discontinue decelerating and maintain speed. Once the DC Bus voltage has dropped below the stall prevention level, the deceleration will continue down to the Speed Command level. See figure below.

Drive Voltage		Stall Prevention Level during Deceleration (V)
240 VAC		380
480 VAC	E1-01 ≥ 400 VAC	760
	E1-01 < 400 VAC	660

If L3-01= “2: Intelligent”, the intelligent stall prevention is enabled. The active deceleration time is ignored and the Drive will attempt to decelerate as quickly as possible without causing the DC Bus voltage to exceed the stall prevention level.

The following figure demonstrates acceleration when L3-04= “1 General Purpose”.

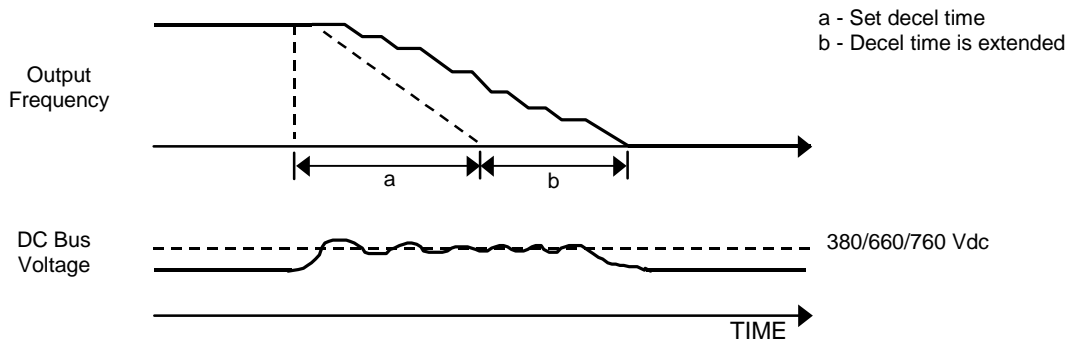

Fig 5.32 Time Chart for Stall Prevention During Deceleration

■ L3-05 Stall Prevention Selection During Running

Setting	Description
0	Disabled
1	Decel Time 1 (<i>factory default</i>)
2	Decel Time 2

■ L3-06 Stall Prevention Level During Running

Setting Range: 30 to 200% of Drive rated output current

Factory Default: 120% of Drive rated output current

The Stall Prevention During Running function will attempt to avoid a Drive OC fault occurrence while the Drive is operating at a constant speed. If L3-05= “0: Disabled”, the Drive may fault if the load increases sufficiently to cause the output current to reach the OC fault level (180% of Drive rated output current).

If L3-05= “1: General Purpose”, the Drive is outputting a constant speed, and the Drive’s output current level exceeds the level set by parameter L3-06 for more than 100 ms the Drive will begin to decelerate at the rate specified by parameter C1-02. The Drive will continue to decelerate until the output current level drops below the L3-06 level (less a 2% hysteresis). Once the output current drops below the L3-06 – 2% level the Drive will begin to accelerate at the currently active acceleration rate (either C1-01 or C1-03).

If L3-05= “2: Decel Time 2”, the Drive will function as described above except C1-04 will be used instead of C1-02 as the deceleration rate used when the output current exceeds L3-06 for more than 100 ms.

The following figure demonstrates acceleration when L3-05≠0.

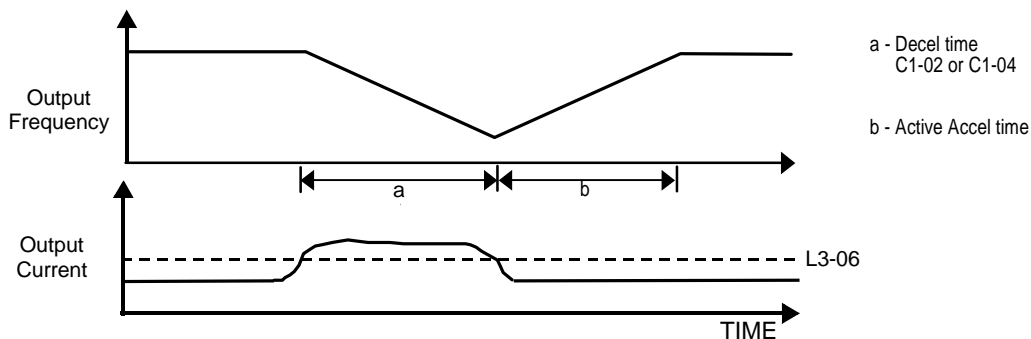

Fig 5.33 Time Chart for Stall Prevention Level During Running

The L3-06 parameter is set as a percentage of the Drive rated output current. If the Drive still faults when L3-05≠0, then either lower the L3-06 or adjust the C1-02 or C1-04 settings for a quicker deceleration.

◆ L4 Speed Command Loss Detection

■ L4-05 Frequency Reference Loss Detection Selection

Setting	Description
0	Disabled (<i>factory default</i>)
1	Enabled @ % of PrevRef

■ L4-06 Frequency Reference at Loss of Frequency Reference

Setting Range: 0.0 to 100.0% of previous speed command

Factory Default: 80.0% of previous speed command

The Drive can be configured to compensate for the loss of its external speed command. An external speed command is considered lost if it drops 90% of its value in 400mS or less.

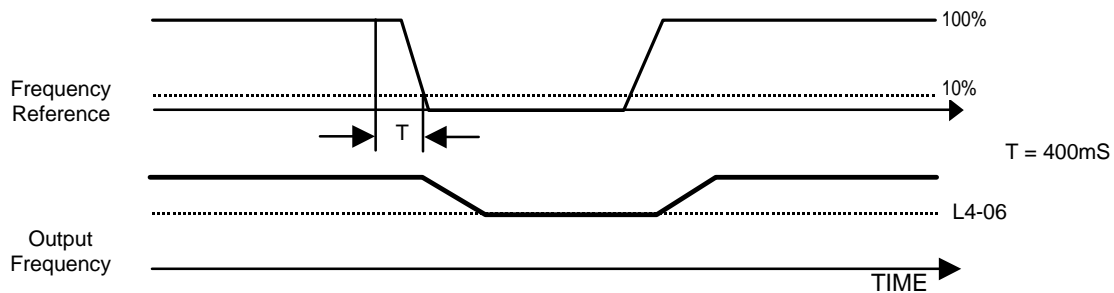

Fig 5.34 Loss of Frequency Reference Timing Diagram

To enable Frequency loss detection, set L4-05= “1: Enabled @ % of PrevRef”. If Frequency Reference Loss Detection is enabled and the reference is lost, the Drive continues to operate at the speed commanded by parameter L4-06. When the speed command returns, the Drive again follows the speed command.

Setting H2-01/H2-02= “C: Loss of Ref”, configures a digital output as a Frequency Reference Loss indication only when L4-05= “1: Enabled @ % of PrevRef”.

◆ L5 Fault Restart

■ L5-01 Number of Auto Restart Attempts

Setting Range: 0 to 10

Factory Default: 10

■ L5-02 Auto Restart Operation Selection

Setting	Description
0	No Flt Relay (<i>factory default</i>)
1	Flt Relay Active

■ L5-03 Maximum Restart Time After Fault

Setting Range: 0.5 to 600.0 Seconds

Factory Default: 600.0 Seconds

All major faults will cause the Drive to stop. For some faults it is possible to configure the Drive to attempt a restart automatically. After the fault occurs, the Drive baseblocks for L2-03 seconds. After the baseblock is removed the Drive checks if a fault condition still exists. If no fault condition exists the Drive will attempt to restart the motor. If the restart is successful, the Drive performs a Speed Search (Regardless of the status of b3-01 “Speed Search Selection”) from the set speed command and the Auto Restart Attempts count is increased by one. Even if the restart fails the restart count is increased by one as long as the Drive attempted to rotate the motor. The restart count will not be incremented if the restart is not attempted due to a continuing fault condition (i.e. an OV fault). The Drive waits L5-03 seconds before attempting another restart.

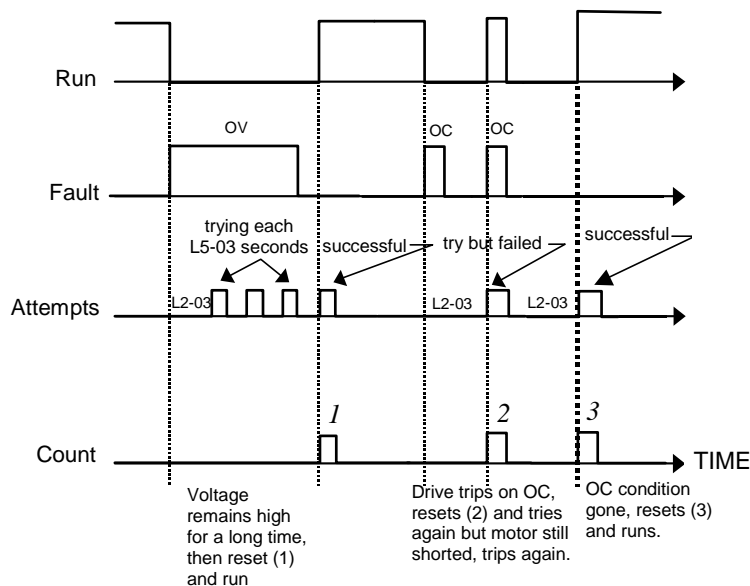

Fig 5.35 Automatic Restart Timing Diagram

The auto restart count is reset back to 0 if any of the following occur:

- No further faults for ten minutes after the last retry.
- The Drives power is turned off (the Drive must be without power long enough to let control power dissipate).
- The SHIFT/RESET key is pushed after the last reset attempt.

The setting of parameter L5-02 determines whether the fault output (MA-MB) will be closed during an auto restart attempt. The setting of L5-02 can be important when interfacing the Drive with other equipment.

The following faults will allow the Auto Restart function to initiate:

- OC (Overcurrent)
- LF (Output Open Phase)
- PF (Input Phase Loss)
- PUF (DC Bus Fuse)
- OL1 (Motor Overload)
- OL3 (Overtorque)
- OL2 (Drive Overload)
- OV (DC Bus Overvoltage)
- GF (Ground Fault)
- UV1 (DC Bus Undervoltage)
- OH1 (Overheat)

In order for auto restart after a UV1 fault, Momentary Power Loss Ride-thru must be enabled (L2-01= “1: PwrL Ride Thru t”, or “2: CPU Power Active”). Setting H2-01 or H2-02 equal to “1E” configures a digital output as “Restart Enabled” to signal if an impending auto restart is possible.

◆ L6 Torque Detection

■ L6-01 Torque Detection Selection 1

Setting	Description
0	Disabled (<i>factory default</i>)
1	OL@SpdAgree - Alm
2	OL At Run -Alm
3	OL@SpdAgree - Flt
4	OL At Run - Flt
5	UL@SpdAgree - Alm
6	UL at Run - Alm
7	UL@SpdAgree - Flt
8	UL At Run - Flt

■ L6-02 Torque Detection Level 1

Setting Range: 0 to 300% of Drive rated output current

Factory Default: 15% of Drive rated output current

■ L6-03 Torque Detection Time 1

Setting Range: 0.0 to 10.0 Seconds

Factory Default: 10.0 Seconds

The Drive can be programmed to indicate when either an overtorque or an undertorque conditions exist. A digital output must be programmed for “Torque Detection”, (H2-01/H2-02= “B: Trq Det 1 N.O.” or “17: Trq Det 1 N.C.”). A warning of an overtorque condition can indicate a jam and an undertorque condition can indicate a broken belt, no water in a pump, or other loss of load.

To configure Torque Detection requires the following decisions:

1. Do you wish to check for an overtorque condition or an undertorque condition?
2. Do you wish to check for the torque condition whenever the Drive is running or only at speed agree? Nuisance detection during acceleration, when variable torques are normally required, can be avoided.
3. Do you want the Drive to fault if the torque condition is detected or only alarm and continue operation?

The following table can help choose the proper setting for Torque Detection Selection 1 to get the wanted results.

L6-01 Setting	Overtorque	Undertorque	Fault	Alarm	Always Detected	Only Detected @ Spd Agree
0	Torque Detection Disabled					
1	X			X		X
2	X			X	X	
3	X		X			X
4	X		X		X	
5*		X		X		X
6		X		X	X	
7		X				X
8		X			X	

*Suggested settings for Loss of Load indication

After selecting the proper detection scheme the Torque Detection Level (L6-02) must be specified. If the current level read by the output current transformers rises above (overtorque) or drops below (undertorque) this level, and remains there for at least the Torque Detection Time (L6-03), then the Torque Detection Function will change the state of any digital output configured for Torque Detection (H2-01/H2-02= "B: Trq Det 1 N.O.", or "17: Trq Det 1 N.C.").

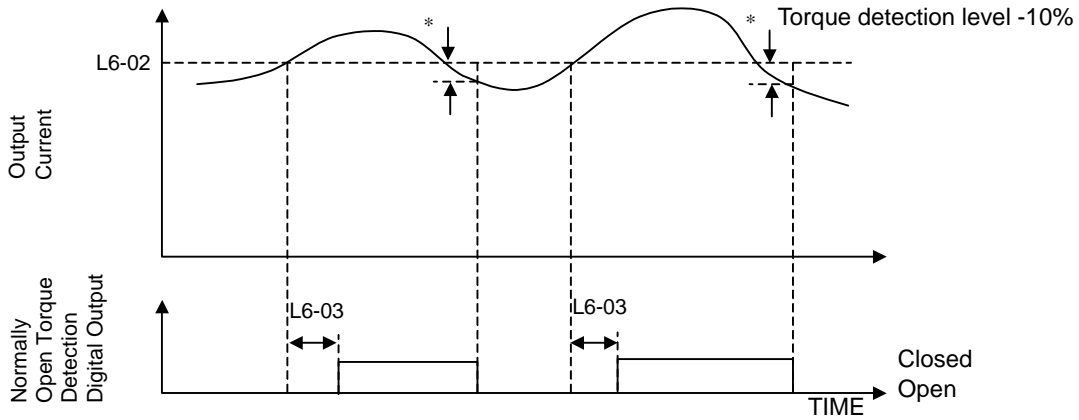

* When the output current drops below the Torque Detection Level by approximately 10% of the Drive's rated output current the digital output is reset.

Fig 5.36 Over Torque Detection

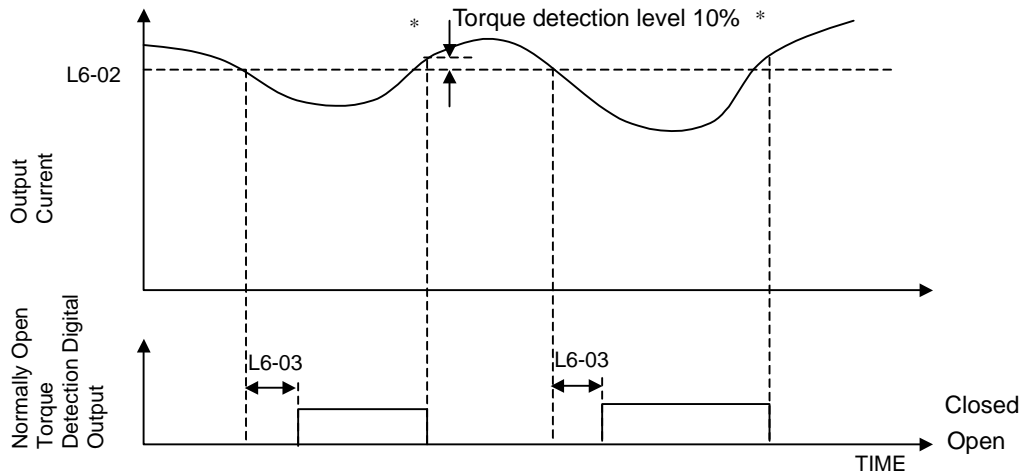

* When the output current rises above the Torque Detection Level by approximately 10% of the Drive's rated output current the digital output is reset.

Fig 5.37 Under Torque Detection

◆ L8 Hardware Protection

■ L8-01 Internal Dynamic Braking Resistor Protection Selection

Setting	Description
0	Not Provided (<i>factory default</i>)
1	Provided

This parameter is not applicable for Drive operation.

■ L8-02 Overheat Pre-Alarm Level

Setting Range: 50 to 130°C

Factory Default: 95°C

■ L8-03 Overheat Pre-Alarm Operation Selection

Setting	Description
0	Ramp to Stop (Decel Time C1-02)
1	Coast to Stop
2	Fast-Stop (Decel Time C1-09)
3	Alarm Only
4	OH Alarm and Reduce (<i>factory default</i>)

The Drive is capable of warning the operator of an impending heatsink over-temperature fault via an OH pre-alarm. The level at which the pre-alarm will activate is determined by the setting of parameter L8-02. Measurement of the heatsink temperature is done with several strategically mounted thermistors. If any of the heatsink thermistors measure a temperature in excess of the setting of L8-02, the Drive will fault (OH2) and either: ramp to stop using the C1-02 deceleration rate (L8-03= “0: Ramp to Stop”), coast to stop (L8-03= “1: Coast to Stop”), ramp to stop using the C1-09 fast stop deceleration rate (L8-03= “2: Fast-Stop”), alarm (OH) and continue running (L8-03 = “3: Alarm Only”), alarm (OH) and continue running but at a reduced speed (L8-03= “4: Alarm & Reduce”). If L8-03= 4: Alarm and Reduce, the Drive will continue to run but will reduce the speed to the level determined by parameter L8-19. Refer to the description for parameter L8-19.

If a digital output is configured for OH Prealarm (H2-01= “20: OH PreAlarm”), it will close whenever the heatsink temperature is greater than the L8-02 level no matter what the setting is of L8-03.

■ L8-10 Heatsink Cooling Fan Operation Selection

Setting	Description
0	Fan On-Run Mode (<i>factory default</i>)
1	Fan Always On

■ L8-11 Heatsink Cooling Fan Operation Delay Time

Setting Range: 0 to 300 Seconds

Factory Default: 300 Seconds

Parameters L8-10 and L8-11 allow the Drive programmer to customize the heatsink cooling fan operation. Parameter L8-10 determines whether the cooling fans are always ON whenever the Drive is powered (L8-10= “1: Fan Always On”) or if the cooling fans are only ON when the Drive is in a Run condition (L8-10= “0: Fan On-Run Mode”).

Parameter L8-11 is a delayed OFF for the cooling fan if L8-10= “0: Fan On-Run Mode”. When the cooling fans are set to turn OFF when the Run command is removed, parameter L8-11 will cause the fans to continue cooling the Drive for the amount of time programmed into L8-11 after the Run command is actually removed. The Drive can be programmed to allow the cooling fan to run for up to 5 minutes (factory default) after the run command is removed.

Both parameters are intended to extend fan life while still providing sufficient cooling for proper Drive operation.



Fig 5.38 Heatsink Cooling Fan Operation Timing Diagram

■ L8-19 Overheat Frequency Reference Reduction Level

Setting Range: 0.0 to 100.0% of maximum frequency

Factory Default: 20.0% of maximum frequency

When the heatsink temperature reaches the OH Pre-alarm level (L8-02) and the Overheat Pre-Alarm Operation Selection parameter is set for Alarm and Reduce (L8-03= “4: OH Alarm & Reduce”), the L8-19 parameter sets the amount of speed decrease that will be applied to the Speed Command in order to lower the heatsink temperature. The decrease in speed will lower the current being switched and conducted by the heat producing output transistors of the Drive.

Parameter L8-19 is set in percentage of maximum frequency (E1-04).

◆ o1 Monitor Configuration

■ o1-01 User Monitor Selection

Setting Range: 6 to 53

Factory Default: 6

Setting	Description
6	Output Voltage (<i>factory default</i>)
7	DC Bus Voltage
8	Output Power
10	Input Terminal Status
11	Output Terminal Status
12	Drive Operation Status
13	Cumulative Operation Time
14	Software Number
15	Terminal A1 Input Voltage
16	Terminal A2 Input Voltage
18	Motor Secondary Current (I_q)
20	Output Frequency After Soft Start
24	PI Feedback Value
28	CPU Number
34	First Parameter Causing an OPE
36	PI Input
37	PI Output
38	PI Setpoint
39	Memobus Communication Error Code
40	Heatsink Cooling Fan Operation Time
51	Auto Mode Frequency Reference Value
52	Hand Mode Frequency Reference Value
53	PI Feedback 2 Value

■ o1-02 Power-On Monitor

Setting	Description
1	Frequency Reference (<i>factory default</i>)
2	Output Frequency
3	Output Current
4	User Monitor (set by o1-01)

When the Drive is powered up, three monitors are displayed on the digital operator. The first and largest monitor is the “Power-On” monitor. The factory default “Power-On monitor” is Speed Command (U1-01). Below the Speed Command monitor are the next two sequential monitors, Output Frequency (U1-02) and Output Current (U1-03). Pressing the INCREASE key once scrolls the monitors to show the User Monitor as selected by o1-01. The factory default for o1-01 is the Output Voltage monitor (U1-06).

The active monitor displayed when the Drive is powered on can be changed to either be U1-01 (Speed Command), U1-02 (Output Frequency), U1-03 (Output Current), or the User Monitor. Whichever monitor is selected as the Power-On top monitor, the two monitors displayed below it are the next two sequential monitors. See example below.

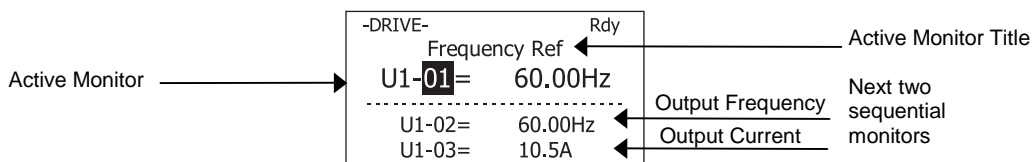

For example, if the Drive needs to display the Elapsed Timer as the Power-On monitor, then o1-01 must be set to “13” and o1-02 must be set to “4”. The next time Drive power is cycled, the digital operator displays U1-13 (Elapsed Time), U1-14 (Flash ID), and U1-15 (Term AI Level).

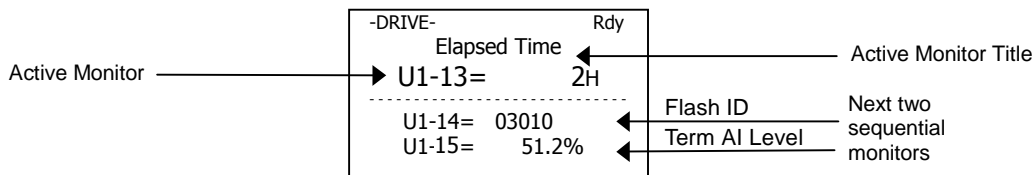

■ o1-03 Digital Operator Display Scaling

Setting	Description
0	Hz (<i>factory default</i>)
1	%
2 - 39	RPM (Enter the # of Motor Poles)
40 - 39999	User Display

Parameter o1-03 allows the programmer to change the units in which the speed monitors and some speed parameters are displayed. The o1-03 parameter will change the units of the following:

- U1-01 (Frequency Reference Monitor)
- U1-02 (Output Frequency Monitor)
- U1-20 (Output Frequency after Soft Start)
- d1-01 through d1-17 (Preset Frequency References and Jog Reference)

The table below details how the setting of o1-03 will affect the way the listed monitors and parameters will be displayed.

If o1-03 is:	The frequency format is
0	0.01 Hz
1	0.00%
2 through 39 (enter the # of motor poles)	0RPM
40 through 39999	Engineering Units

The factory default setting (o1-03= “0”) sets the Drive up to display the affected monitors and parameters in terms of hertz (Hz).

If the speeds seem more natural in terms of percentage of maximum, set o1-03= “1”. If the speeds are easier to work with when displaying the equivalent synchronous motor RPM, set o1-03= [the number of motor poles]. If another engineered unit, such as fpm or gpm, is desired, set o1-03= xxxx where:

 X X X X X
Digit 5 Digit 4 Digit 3 Digit 2 Digit 1

Digits 1 through 4 set the desired number to be displayed at 100% speed.

Digit 5 determines the number of decimal places in the displayed number.

If Digit 5 = 0 number format is XXXX
 If Digit 5 = 1 number format is XXX.X
 If Digit 5 = 2 number format is XX.XX
 If Digit 5 = 3 number format is X.XXX

For example:

If o1-03= 10425, then at full speed the digital operator will display “42.5”. Configuring parameter o1-03 for displaying in terms of an engineering unit is only appropriate if the actual display units have a linear relationship with the actual output speed.

■ o1-05 LCD Contrast Adjustment

Setting Range: 0 to 5
 Factory Default: 3

The contrast setting of the LCD display of the digital operator can be adjusted by the setting of parameter o1-05. The higher the number programmed into o1-05, the darker the background will become. Set o1-05 to the value that makes the LCD the easiest to view at the normal viewing distance and angle.

■ o1-06 User Monitor Selection Mode

Setting	Description
0	3 Mon Sequential (<i>factory default</i>)
1	3 Mon Selectable

■ o1-07 Second Line User Monitor

Setting Range: 1 to 53
 Factory Default: 2

■ o1-08 Third Line User Monitor

Setting Range: 1 to 53
 Factory Default: 3

Normally the monitors shown directly below the active monitor are the next two sequential monitors. If o1-06 (User Monitor Selection Mode) is set to “1: 3 Mon Selectable”, those two monitors are locked as specified by parameters o1-07 and o1-08 and will not change as the top parameter is scrolled with the INCREASE and DECREASE keys.

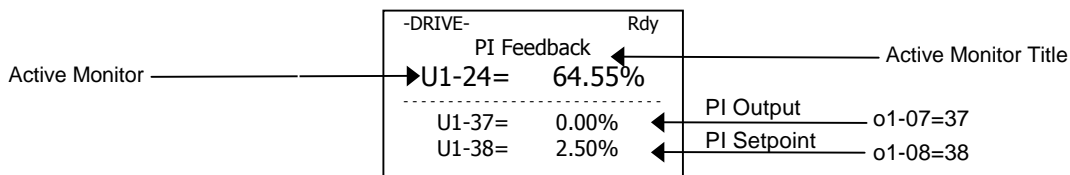

For Example:

The Display above showing PI Feedback, PI Output and PI Setpoint would be useful when setting up a PI Control Loop.

◆ o2 Key Selections

■ o2-03 User Parameter Default Value

Setting	Description
0	No Change
1	Set Defaults
2	Clear All

The Drive gives the option of configuring any and all of the programming parameters and then saving the parameters as “User Initialization Values”. After configuring the Drive, set parameter o2-03= “1: Set Defaults”, to save the parameters to a User Initialization memory location. Once this has been done, the “Initialize Parameters” parameter (A1-03) will offer the choice of “1110:User Initialize”. Choosing A1-03= “1110: User Initialized”, will reset all modified parameters back to what they were the last time they were saved using o2-03.

The choice of setting A1-03= “1110: User Initialized”, is unavailable until first setting the User Initialization parameters using o2-03. Once a User Initialization is set (saved), it can be cleared by setting o2-03= “2: Clear All”. After clearing the User Initialization parameters, the choice of “1110: User Initialize” is no longer available in A1-03.

■ o2-05 Frequency Reference Setting Method Selection

Setting	Description
0	Disabled
1	Enabled (<i>factory default</i>)

The factory default setting of the Frequency Reference Setting Method parameter (o2-05= “1: Enabled”) dictates that when setting a Speed Command via the digital operator (“Hand” mode), it is not necessary to press the DATA/ENTER key before the Drive will begin to accelerate or decelerate to the new set speed. This is referred to as MOP (Motor Operated Potentiometer) type functionality. When o2-05= “1: Enabled”, the speed command is stored to memory 5 seconds after the INCREASE or DECREASE keys are released.

When o2-05= “0: Disabled”, the digital operator INCREASE and DECREASE keys will change the speed command but the Drive will not accelerate or decelerate to the new speed command until the DATA/ENTER key is pressed. In order to change the Speed Command in the HAND mode, U1-01 must be the top monitor and then the ENTER key must be pressed in order to access the Speed Command function. This is not to be confused with pressing the ENTER key in order to achieve a change in speed using the INCREASE and DECREASE keys, which is the subject of parameter o2-05.

■ o2-06 Operation Selection when Digital Operator is Disconnected

Setting	Description
0	Disabled
1	Enabled (<i>factory default</i>)

Leaving o2-06 enabled will cause the Drive to fault, when the digital operator is removed, even if it's not outputting to the motor. The reset key on the digital operator will need to be pressed after reconnecting the digital operator to reset the fault and continue normal operation.

If o2-06 = "0: Disabled" then the Drive will not fault if the digital operator is disconnected, but the Drive will discontinue motor operation. If full Drive operation is required while the digital operator is removed set o2-06 = "0: Disabled" and o2-15 = "0: Disabled" (Hand Key Function). If both o2-06 and o2-15 are disabled then the digital operator can be disconnected without disturbing Drive operation.

■ o2-07 Cumulative Operating Time Setting

Setting Range: 0 to 65535 Hours

Factory Default: 0 Hours

■ o2-08 Cumulative Operation Time Selection

Setting	Description
0	Power-On Time
1	Running Time (<i>factory default</i>)

The Drive features an Elapsed Timer monitor that records in units of hours. The Elapsed Timer monitor is U1-13. Parameter o2-08 programs this function to either accumulate elapsed hours based on time the Drive is powered (o2-08= "0: Power-On Time") or time the Drive is running (o2-08= "1: Running Time"). The Drive is considered "running" anytime there is an active run command or when the Drive is outputting voltage (i.e. including during deceleration).

-DRIVE-	Rdy
Elapsed Time	
U1-13= 0H	

U1-14= 03010	
U1-15= 34.1%	

Parameter o2-07 allows manual adjustment of the Elapsed Timer, primarily to accommodate maintenance or control board replacement in the event of damage. To reset the Elapsed Timer back to zero, set o2-07= 0.

■ o2-10 Cumulative Cooling Fan Operation Time Setting

Setting Range: 0 to 65535 Hours

Factory Default: 0 Hours

The elapsed time of heatsink cooling fan operation is tracked by the U1-40 monitor. Much like the o2-07 parameter can be used to adjust or reset the Drive operation elapsed timer, parameter o2-10 can be used to adjust the time displayed by the U1-40 monitor in the event of fan replacement.

-DRIVE-	Rdy
FAN Elapsed Time	
U1-40= 152H	

U1-51= 52.33%	
U1-52= 57.60%	

■ o2-12 Fault Trace / Fault History Clear Function

Setting	Description
0	Disabled (No Effect) (<i>factory default</i>)
1	Enabled

The operator can clear the Fault Trace (U2) and Fault History logs by setting o2-12= “1: Enabled”. Clearing the Fault Trace and Fault History logs erases all the information.

■ o2-14 kWh User Monitor Initialization

Setting	Description
0	Disabled (No Change) (<i>factory default</i>)
1	Clear All

The kWh monitors (U1-29 and U1-30) track the power usage of the Drive and are not reset by powering down the Drive. To reset the monitors back to zero, set o2-14= “1: Clear all”.

◆ o3 Digital Operator Copy Function

■ o3-01 Copy Function Selection

The membrane over the Drive keypad also makes the keypad non-removable on Bypass units. In order to use the keypad copy function on a Bypass unit - order a separate keypad, part number CDR001115 and obtain locally a standard CAT 5 Ethernet cable.

Note: The copy function is disabled when serial communication is active.

Setting	Description
0	COPY SELECT (<i>factory default</i>)
1	INV→OP READ
2	OP→INV WRITE
3	OP↔INV VERIFY

■ o3-02 Read Allowed Selection

Setting	Description
0	Disabled
1	Enabled (<i>factory default</i>)

The digital operator has parameter COPY capabilities via built in non-volatile memory. The digital operator can READ all of the parameters in the Drive and store them for later WRITE back to the Drive or into a Drive with the same product code and software number. In order to read the parameter values and store them in the digital operator, select o3-02= “1: Enabled”. If you attempt to READ the data, which overwrites any previously stored data, without first setting o3-02= “1: Enabled”, you will get the following error:

-ADV- PRE READ IMPOSSIBLE

After setting o3-02= “1: Enabled”, it is possible to store parameter values in the digital operator by setting o3-01=1 (INV→OP READ).

A successful READ of the parameter values will display:

-ADV- READ READ COMPLETE

An error may occur while saving the parameter values to the digital operator's memory. If an error is displayed, press any key to cancel the error display and return to parameter o3-01. To COPY parameter values into a Drive, set o3-01= "2: OP->INV WRITE". During the writing of the parameter values into the Drive the digital operator will display:

-ADV-
COPY
OP->INV COPYING

A successful COPY of the parameter values will display:

-ADV-
COPY
COPY COMPLETE

An error may occur while writing the parameter values to the Drive. If an error is displayed, press any key to cancel the error display and return to parameter o3-01.

It is possible to compare the parameter values stored in the digital operator with the parameter values currently in the Drive by using the VERIFY function. This VERIFY function should not be confused with the "-VERIFY-" that is displayed on the digital operator when viewing the "Modified Constants" menu. To VERIFY the parameter values in the Drive as compared with those stored in the digital operator, set o3-01= "3: OP<-->INV VERIFY". During the comparing of the parameter values into the Drive the digital operator will display:

-ADV-
VERIFY
DATA VERIFYING

A successful VERIFY of the parameter values will display:

-ADV-
VERIFY
VERIFY COMPLETE

If all the parameter values stored in the digital operator do not match those programmed in the Drive, the digital operator displays the following:

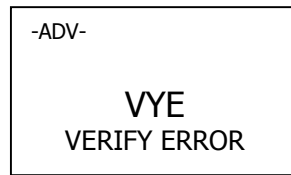

The digital operator will not display which parameters did not match, only that the verification found discrepancies in some parameter values.

NOTE: In order to properly use the COPY or VERIFY functions, the following Drive specifications must be identical between the Drive that the parameters were read from and the Drive that the parameters are to be written to:

- Model Number (e.g. CIMR-P7U2015)
- Software Number (e.g. 1010 also known as FLASH ID)

Yaskawa offers DriveWizard™ software that can also READ, COPY, and VERIFY Drive parameter values. DriveWizard™ lists all discrepancies between the Drive and a pre-saved parameter file when verifying is performed.

To use DriveWizard first select o2-15= "0: Disabled" and select o2-06= "0: Disabled" then remove the digital operator/keypad and attach the DriveWizard cable in its place.

◆ T1 Auto-Tuning

Auto-Tuning can only be accomplished through the DriveWizard software. Available by download from www.drives.com.

■ T1-02 Motor Rated Power

Setting Range: 0.00 to 650.00 kW

Factory Default: Model Dependent

■ T1-04 Motor Rated Current

Setting Range: Model Dependent

Factory Default: Model Dependent

Auto tuning is recommended to achieve optimum performance. In addition, the Drive requires Line-To-Line Resistance auto-tuning before it can properly perform the Estimated Speed Search method. This method of speed search allows for bi-directional speed search. The T1 parameters are found under the Auto-Tuning menu.

■ Auto-Tuning Using DriveWizard

DriveWizard is a PC software program designed to provide the tools necessary to handle Drive installation as well as parameter record keeping and maintenance. As such it provides an Auto-Tuning method for Drives in Bypass units. The Auto-Tuning function “tunes” the Drive setup to the characteristics of the specific motor to which it is applied. Auto-Tuning is essential if bi-directional Speed Search is required and enabled for the application.

DriveWizard can be obtained either through CD or www.Drives.com. Follow the installation procedures provided with the software.

With the DriveWizard software loaded onto a PC, connect a standard CAT 5 Ethernet cable from the PC's RS-232 port (with a DB-9 to CAT 5 adaptor) to the digital operator/keypad port on the Drive. Before disconnecting the digital operator/keypad from the Drive, set parameter **o2-06** (“Oper Detection”) to “0:disabled”. This will allow the Drive to continue running with the digital operator/keypad removed.

Start DriveWizard and setup the PC communications by setting the appropriate communications port and Baud rate. Typical settings are Com Port 1 and 9600 Baud.

Once the communications port is set, connect to the Drive by clicking on the pull-down menu “Inverter” and selecting “Connect.” [This can also be done by typing Ctrl+C on your keyboard, or by clicking on the yellow icon resembling two puzzle pieces.] This will upload all of the current parameters in the Drive to the computer as a working parameter file.

At this point the parameters can be saved as a backup file if desired. [DriveWizard is a third method of saving the complete parameter list and user settings. In addition to the “User Parameters” (**o2-03**) and “Keypad Copy” (**o3-01**) functions discussed in this chapter, DriveWizard can be employed to maintain a downloadable list of the Drive parameter set up on a PC, for backup or transfer to other drives.]

Auto-Tuning is performed by selecting the Auto-Tuning function from the “Inverter” pull-down menu. DriveWizard will ask you to verify that the motor is in a safe operating condition, and then ask you to enter two parameters. DriveWizard will ask you to fill in parameters **T1-02** “Mtr Rated Power” and **T1-04** “Rated Current”. After this data has been entered, click on the “Load” button to enter these values into the Drive memory. The “Start” button will become available, click on “Start” to begin the auto-tuning process. While Auto-Tuning is running the Drive output current and frequency will be displayed, the flashing green light indicates DriveWizard is communicating with the Drive. When complete, DriveWizard will have auto-tuned the Drive, adjusted several motor related parameters and the Drive will be ready for optimum performance for bi-directional Speed Search and other functions.

Notes:

Chapter 6

Diagnostics & Troubleshooting

This chapter describes diagnostics and troubleshooting for the Drive.

Bypass Diagnostics	2
Troubleshooting the Bypass Printed Circuit Boards	2
Drive Diagnostics	3
Fault Detection	4
Alarm Detection	10
Operator Programming Errors (OPE)	13
Auto-Tuning Faults	14
Digital Operator COPY Function Faults	15
Drive Troubleshooting	16
If Parameter Cannot Be Set	16
If the Motor Does Not Operate	17
The Direction of the Motor Rotation is Reversed	18
If the Motor Does Not Put Out Torque or If Acceleration is Slow	18
If the Motor Operates at a Higher Speed Than the Speed Command	18
If the Motor Overheats	19
If Peripheral Devices Like PLCs or Others are Influenced by Starting or Running Drive	19
If the Ground Fault Interrupter Operates When the Drive is Run	20
If There is Mechanical Vibration	20
If the Motor Rotates Even When Drive Output is Stopped	21
If Zero Volts is Detected When a Motor is Started, or Stalls	21
If Output Frequency Does Not Rise to Frequency Reference .	21
Drive Main Circuit Test Procedure	22
Drive Date Stamp Information	26

Bypass Diagnostics

◆ Troubleshooting the Bypass Printed Circuit Boards

In order to check the two circuit boards (PCB A2 and A3 on the schematic diagram in Chapter 2) based on the following table, it is assumed that they are assembled and wired in the unit and all the Bypass functions were working properly prior to the fault.

No.	Fault Description	Possible Cause	Corrective Procedure
1	No lights, some/no contactors pick up	Control circuit fuses are blown	Check for any short circuits before replacing the fuses
2	No. 1 but fuses are not blown	Power/wiring is disrupted to cabinet and/or transformer	Check the power to the control transformer/cabinet
3	No. 2 but power has no problem	The Ribbon cable and/or Operator (A3) board are faulty	Check for the cause/shorting before ordering replacement
4	No. 3 but Operator (A3) board and ribbon cable OK	The wiring to Relay (A2) board is loose/Relay board faulty	Inspect the wiring/connectors to relay board before ordering replacement
5	Power light on, contactors do not pick up	Control circuit fuses are blown	Check for any short circuits/wiring before replacing the fuses
6	No. 5 but fuses are not blown	User connections to TB1 are disrupted	Inspect connections to TB1
7	No. 6 but TB1 connections are secure	The contactors/wiring are faulty/disrupted	Inspect contactors and check the power at the contactor
8	No. 7 but wiring and contactors OK	The wiring to Relay (A2) board is loose/Relay board faulty	Inspect the wiring/connectors to relay (A2) board before ordering replacement
9	Contactor/blowers pick up with delay	Bad connection/relays, loose circuit boards	Check TB1 wiring/PCB ribbon cable sockets before ordering replacement
10	Some options do not work anymore	Loose wiring/connectors on Relay (A2) and/or Operator (A3) boards	Inspect the Relay (A2) board wiring/connectors/jumpers
11	Any light off but functions are right	Bad light module, loose Operator (A3) board/cable	Read 8-12 VAC voltage on Operator board light pins before ordering replacement
12	User functions on TB1 terminals 7 to 16 faulty	Bad user wiring, shorting to TB1 terminals, bad relays	Check the wiring and terminals on TB1 before ordering replacement
13	Auto/Remote/Purge Functions faulty	Loose wiring on TB1, bad switches of Relay (A2) board	Inspect wiring/Relay board switches, TB1 inputs before ordering replacement
14	Drive/Damper Solenoid does not operate	Loose wiring on Drive terminals, incomplete TB1 connections	Inspect Drive wiring, TB1 connections

Drive Diagnostics

Drives Technical Support in USA and Canada

Technical Support for Inverters and Drives is available by phone as follows:

Normal: Monday through Friday during the hours of 8 a.m. to 5:00 p.m. C.S.T.
Emergency: After normal hours, 7 days a week including weekends and holidays

To contact Drives Technical Support, please call 1-800-YASKAWA (927-5292).
From the menu, dial 2 for Inverter and Drive Products, then 5 for Technical Support.

Drives Technical Support can also be reached by e-mail at DriveSupport@yaskawa.com.
Support information, such as technical manuals, FAQs, instruction sheets and software downloads are available at our website, www.drives.com.

When calling for technical support, please have the following materials available:

- The appropriate Technical Manual in hand because the support associate may refer to this.
- Complete nameplate information from the Drive and the motor.
(Confirm that Drive Nameplate Output amps is equal to or greater than Motor Nameplate amps)
- A list with your parameter settings.
- A sketch of the electrical power train, from AC line to motor, including filters and disconnects.

Field Service, Start Up Assistance, Factory Repair, Replacement Parts, and Other Support

Contact Drives Technical Support for help with any of these needs.

Technical Training

Training is conducted at Yaskawa training centers, at customer sites, and via the internet.
For information, visit www.drives.com or call 1-800-YASKAWA (927-5292).
From the phone menu, dial 2 for Inverter and Drive Products, then 4 for Product Training.

Support in Other Countries

Yaskawa is a multi-national company with offices and service representation around the world.
To obtain support, always contact the local distributor first for guidance and assistance.

Contact the closest Yaskawa office listed for further assistance.

◆ Fault Detection

When the Drive detects a fault, the fault information is displayed on the digital operator, the fault contact closes, and the motor coasts to stop. (However, a fault with selectable stopping method will operate according to the stopping method selected.)

- If a fault occurs, take appropriate action according to the table by investigating the cause.
- To restart, reset the fault with any of the following procedures:
 - Turn ON the fault reset signal.
 - Set “14: Fault Reset” to a multi-function digital input (H1-01 to H1-05).
 - Press the RESET key of the digital operator.
 - Shut off the Drive input power once, and then turn on again.

WARNING

The Run Command (Start Command) needs to be removed prior to resetting a fault. Resetting a fault by removing and reapplying power to the Drive while the Run Command is applied, may cause the Drive to start unexpectedly. Therefore, make sure all personnel are clear from the Drive, motor, and machine prior to resetting the Drive.

Table 6.1 Fault Displays and Processing

Digital Operator Display	Description	Cause	Corrective Action
BUS Option Com Err	Option Communication Error After initial communication was established, the connection was lost.	Connection is broken, master has stopped communicating.	Check all connections, verify all user-side software configurations.
CE Memobus Com Err	Modbus Communication Error Control data was not received correctly for two seconds.	Connection is broken, master has stopped communicating.	Check all connections, verify all user-side software configurations.
CPF00 COM-ERR(OP&INV)	Operator Communication Fault 1 Transmission between the Drive and the digital operator cannot be established within 5 seconds after supplying power.	Digital operator cable not securely connected, digital operator defective, control board defective.	Remove the digital operator once and then reinstall it.
	External RAM of CPU is defective.	Control circuit damage.	Cycle power off and on to the Drive. Replace the Drive.
CPF01 COM-ERR(OP&INV)	Operator Communication Fault 2 After communication started with the digital operator, a communication fault occurred for 2 seconds or more.	Digital operator cable not securely connected, digital operator defective, control board defective.	Remove the digital operator once and then reinstall it.
			Cycle power off and on to the Drive.
			Replace the Drive.
CPF02 BB Circuit Err	Baseblock Circuit Fault Baseblock circuit fault at power-up	Gate array hardware failure during power-up.	Perform a factory initialization.
			Cycle power off and on to the Drive.
			Replace the control board.
CPF03 EEPROM Error	EEPROM Fault EEPROM fault, check sum not valid	Noise or spike on the control circuit input terminals.	Perform a factory initialization
			Cycle power off and on to the Drive.
			Replace the control board.

Table 6.1 Fault Displays and Processing

Digital Operator Display	Description	Cause	Corrective Action
CPF04 Internal A/D Err	CPU Internal A/D Converter Fault	Noise or spike on the control circuit input terminals.	Perform a factory initialization.
			Cycle power off and on to the Drive.
			Replace the control board.
CPF05 External A/D Err	CPU External A/D Converter Fault	Noise or spike on the control circuit input terminals.	Perform a factory initialization.
			Cycle power off and on to the Drive.
			Replace the control board.
CPF07 RAM-Err	ASIC Internal RAM Fault (RAM)	---	Cycle power off and on to the Drive.
		Control circuit damage	Replace the Drive.
CPF08 WAT-Err	Watchdog Timer Fault (WAT)	---	Cycle power off and on to the Drive.
		Control circuit damage	Replace the Drive.
CPF09 CPU-Err	CPU-ASIC Mutual Diagnosis Fault (COY)	---	Cycle power off and on to the Drive.
		Control circuit damage	Replace the Drive.
CPF10 ASIC-Err	ASIC Version Fault (ASIC)	Control circuit damage	Replace the Drive.
CPF20 Option A/D Error	Option Card Fault	Option card connector connection fault.	Remove all inputs to the option board.
		Option card A/D converter fault.	Perform a factory initialization.
			Cycle power off and on to the Drive.
			Replace the option board.
CPF21 Option CPU Down	Self-diagnosis Fault of Communication Option Card	Noise or spike on the communication line, defective option board.	Replace the Control board.
			Perform a factory initialization.
			Cycle power off and on to the Drive.
			Replace the option board.
CPF22 Option Type Err	Communication Option Card Code Number Fault	Unrecognizable option board is connected to the control board.	Replace the control board.
			Remove any option boards.
			Cycle power off and on to the Drive.
			Perform a factory initialization.
			Replace the option board.
			Replace the control board.

Table 6.1 Fault Displays and Processing

Digital Operator Display	Description	Cause	Corrective Action
CPF23 Option DPRAM Err	Communication Option Card Interconnection Fault	An option board is not correctly connected to the control board or an option board that is not made for the Drive is attached to the control board.	Remove power to the Drive.
			Connect the option board once more.
			Perform a factory initialization.
			Cycle power off and on to the Drive.
			Replace the option board.
			Replace the control board.
EF0 Opt External Flt	Communication Option Card External Fault	An external fault condition exists.	Check for an external condition.
			Verify the parameters.
			Verify communication signal.
EF3 Ext Fault S3	External Fault at Terminal S3	An external fault condition exists connected to a multi-function digital input.	Eliminate the cause of an external fault condition.
EF4 Ext Fault S4	External Fault at Terminal S4		
EF5 Ext Fault S5	External Fault at Terminal S5		
EF6 Ext Fault S6	External Fault at Terminal S6		
EF7 Ext Fault S7	External Fault at Terminal S7		
FBL Feedback Loss	PI Feedback Loss This fault occurs when PI Feedback Loss Detection is programmed to fault. (b5-12 = 2) and the PI Feedback < PI Feedback Loss Detection Level (b5-13) for the PI Feedback Loss Detection Time (b5-14).	PI Feedback source (e.g. transducer, sensor, building automation signal) is not installed correctly or is not working.	Verify Drive is programmed to receive the PI Feedback source signal.
			Check to ensure the PI Feedback source is installed and working properly.
GF Ground Fault	Output Ground Fault Drive output grounding current has exceeded 50% of the Drive rated output current.	Motor lead is shorted to ground, DCCT defective.	Remove the motor and run the Drive without the motor.
			Check the motor for a phase to ground short.
			Check the output current with a clamp on meter to verify the DCCT reading.

Table 6.1 Fault Displays and Processing

Digital Operator Display	Description	Cause	Corrective Action
OC Over Current	Overcurrent Drive output current exceeded the overcurrent detection level (approximately 180% of Drive rated output current).	Shorted Drive output phase to phase, shorted motor, locked rotor, load too heavy, accel/ decel time too short, contactor on the Drive output is opened and closed, a special motor or a motor with a FLA rating larger than Drive rated output current.	Remove the motor and run the Drive without the motor.
			Check the motor for a phase-to-phase short.
			Check the Drive for a phase-to-phase short at the output.
			Verify C1-01 and C1-02 are set correctly.
			Check load conditions.
OH1 Heatsnk MAX Temp	Cooling Fin/Cooling Fin Fan Overheat The temperature of the Drive cooling fin exceeded the temperature programmed in parameter L8-02.	Cooling fan(s) are not working, high ambient temperature, a heat source is too close to the Drive.	Check for dirt build-up on the fans and cooling fins.
	Drive Internal Cooling Fan		Reduce the ambient temperature around the Drive. Remove the heating unit.
OH3 Motor Overheat 1	Motor Overheating Alarm The Drive stops or continues operation according to the setting of L1-03.	Overheating of motor as measured by motor thermistor.	Recheck the cycle time and the size of the load.
			Recheck the accel/decel time (C1-01 and C1-02).
			Recheck the V/F pattern (E1-01 thru E1-13).
			Recheck the motor rated current value (E2-01).
OH4 Motor Overheat 2	Motor Overheating Fault The Drive stops operation according to the setting of L1-04.	Overheating of motor as measured by motor thermistor.	Recheck the cycle time and the size of the load.
			Recheck the accel/decel time (C1-01 and C1-02).
			Recheck the V/F pattern (E1-01 thru E1-13).
			Recheck the motor rated current value (E2-01).
OL1 Motor Overloaded	Motor Overload Designed to protect the motor Fully adjustable from parameter E2-01	The load is too large. The cycle time is too short at the accel/decel time.	Recheck the cycle time and the size of the load as well as the times set in C1-01 and C1-02.
		The voltage of the V/F pattern is high.	Review the V/F pattern parameters, E1-01 thru E1-13.
		Motor rated current setting is improper.	Check the motor rated current value in E2-01.
OL2 Inv Overloaded	Drive Overload Designed to protect the Drive	The load is too large. The cycle time is too short at the accel/decel time.	Recheck the cycle time and the size of the load as well as the times set in C1-01 and C1-02.
		The voltage of the V/F pattern is high.	Review the V/F pattern parameters, E1-01 thru E1-13.
		The size of the Drive is small.	Change to a larger size Drive.

Table 6.1 Fault Displays and Processing

Digital Operator Display	Description	Cause	Corrective Action
OL3 Overtorque Det 1	Overtorque Detection 1 Drive output current > L6-02 for more than the time set in L6-03	Motor is overloaded.	Ensure the values in L6-02 and L6-03 are appropriate.
			Check application/machine status to eliminate fault.
OPR Oper Disconnect	Digital Operator Connection Fault The Drive will stop if the digital operator is removed when the Drive is commanded to run through the digital operator.	The digital operator is not attached or the digital operator connector is broken.	Attach the digital operator.
			Check the digital operator connector.
			Verify the setting of o2-06.
OV DC Bus Overvolt	DC Bus Overvoltage 208-240VAC: Trip point is $\geq 400Vdc$ 480VAC: Trip point is $\geq 800Vdc$	High input voltage at R/L1, S/L2 and T/L3.	Check the input circuit and reduce the input power to within specifications.
		The deceleration time is set too short.	Extend the time in C1-02.
		Power factor correction capacitors are being used on the input to the Drive.	Remove the power factor correction capacitors.
PF Input Pha Loss	Input Phase Loss Drive input power supply has an open phase or has a large imbalance of input voltage.	Open phase on the input of the Drive.	Check the input voltage.
		Loose terminal screws at R/L1, S/L2 or T/L3.	Tighten the terminal screws.
		Momentary power loss occurred.	Check the input voltage.
		Input voltage fluctuation too large.	Check the input voltage.
		Parameter L8-06 value is set incorrectly.	Adjust L8-06 according to your application. The higher the value the less sensitive it becomes.
PUF DC Bus Fuse Open	DC Bus Fuse Detects if the DC bus fuse has opened	Shorted output transistor(s) or terminals.	Remove power from the Drive.
			Disconnect the motor.
			Perform the checks without power in Table 6.6.
			Replace the shorted component(s).
			Replace the defective fuse.
RH DynBrk Resistor	Dynamic Braking Resistor The protection of the dynamic braking resistor based on setting of L8-01	Overhauling load, extended dynamic braking duty cycle, defective dynamic braking resistor.	Verify dynamic braking duty cycle.
			Monitor DC bus voltage.
			Replace dynamic braking resistor.

Table 6.1 Fault Displays and Processing

Digital Operator Display	Description	Cause	Corrective Action
RR DynBrk Transistr	Dynamic Braking Transistor The dynamic braking transistor failed.	Shorted dynamic braking transistor, high DC bus voltage, defective dynamic braking resistor.	Cycle power off and on to the Drive.
			Replace defective dynamic braking transistor or resistor.
			Monitor DC bus voltage.
UL3 Undertorq Det 1	Undertorque Detection 1 Drive output current < L6-02 for more than the time set in L6-03	Motor is underloaded.	Ensure the values in L6-02 and L6-03 are appropriate.
			Check application/machine status to eliminate fault.
UV1 DC Bus Undervolt	DC Bus Undervoltage The DC bus voltage is \leq L2-05 208-240VAC: Trip point is \leq 190Vdc 480VAC: Trip point is \leq 380Vdc	Low input voltage at R/L1, S/L2 and T/L3	Check the input circuit and increase the input power to within specifications.
		The acceleration time is set too short.	Extend the time in C1-01.
		Voltage fluctuation of the input power is too large.	Check the input voltage.
UV2 CTL PS Undervolt	Control Power Supply Undervoltage Undervoltage of the control circuit when running.	External load connected pulling down the Drive power supplies.	Cycle power off and on to the Drive.
			Repair or replace the Power PCB/ Gate Drive PCB.
			Remove all control wiring and test Drive.
UV3 MC Answerback	Soft Charge Circuit Fault The pre-charge contactor opened while the Drive was running.	Contacts on the soft charge contactor are dirty and the soft charge contactor does not function mechanically.	Cycle power off and on to the Drive.
			Check the condition of the soft charge contactor.
			Repair or replace the Power PCB/ Gate Drive PCB.

WARNING

Some features within the PI function group cause the Drive to shut down momentarily (e.g. Sleep Function, Snooze Function, Feedback Loss feature etc.) Upon recovery from the conditions that activate these features, the Drive may start unexpectedly. Therefore, when enabling these features take appropriate measures to notify personnel working with this equipment that unexpected starting may occur.

◆ Alarm Detection

Alarms are Drive protection functions that does not operate the fault contact. The Drive will automatically return to its original status once the cause of the alarm has been removed.

During an alarm condition, the Digital Operator display flashes and an alarm output is generated at the multi-function outputs (H2-01 to H2-02) if programmed.

When an alarm occurs, take appropriate corrective action according to the table below.

Digital Operator Display	Description	Cause	Corrective Action
BUS Option Com Err	Option Communication Error After initial communication was established, the connection was lost.	Connection is broken, master has stopped communicating.	Check all connections, verify all user side software configurations.
CALL SI-F/G ComCall	Serial communication transmission error Communication has not yet been established.	Connection not made properly, user software not configured to the proper baud rate or configuration.	Check all connections, verify all user side software configurations.
EF External Fault	Both the forward and the reverse run commands are input simultaneously for 500mS or more. This alarm stops the motor.	An external forward and reverse command are input simultaneously.	Check external sequence logic.
EF0 Opt External Flt (Flashing)	Communication Option Card External Fault	An external fault condition exists.	Check for an external condition. Verify the parameters. Verify communication signal.
EF3 Ext Fault S3 (Flashing)	External Fault at Terminal S3	An external fault condition exists connected to a multi-function digital input.	Eliminate the cause of an external fault condition.
EF4 Ext Fault S4 (Flashing)	External Fault at Terminal S4		
EF5 Ext Fault S5 (Flashing)	External Fault at Terminal S5		
EF6 Ext Fault S6 (Flashing)	External Fault at Terminal S6		
EF7 Ext Fault S7 (Flashing)	External Fault at Terminal S7		
DNE Drive not Enable (Flashing)	The Drive does not have the enable command when the run command is applied.	The Run command has been applied prior to the enable signal.	Apply the enable command before applying the run command.

Table 6.2 Alarm Displays and Processing (Continued)

Digital Operator Display	Description	Cause	Corrective Action
<p>FBL Feedback Loss</p>	<p>PI Feedback Loss This fault occurs when PI Feedback Loss Detection is programmed to fault. (b5-12 = 2) and the PI Feedback < PI Feedback Loss Detection Level (b5-13) for the PI Feedback Loss Detection Time (b5-14)</p>	<p>PI Feedback source (e.g. transducer, sensor, building automation signal) is not installed correctly or is not working.</p>	<p>Verify Drive is programmed to receive the PI Feedback source signal.</p>
			<p>Check to ensure the PI Feedback source is installed and working properly.</p>
			<p>Check the motor for a phase-to-phase short.</p>
			<p>Check the Drive for a phase-to-phase short at the output.</p>
			<p>Verify C1-01 and C1-02 are set correctly.</p>
			<p>Check load conditions.</p>
<p>OH Heatsnk Overtemp (Flashing)</p>	<p>Cooling Fin/Cooling Fin Fan Overheat The temperature of the Drive cooling fin exceeded the temperature programmed in parameter L8-02.</p>	<p>Cooling fan(s) are not working, high ambient temperature, a heating unit in close proximity to Drive is present.</p>	<p>Check for dirt build-up on the fans and cooling fins.</p>
	<p>Drive Internal Cooling Fan</p>		<p>Reduce the ambient temperature around the Drive.</p>
<p>OH2 Over Heat 2 (Flashing)</p>	<p>Drive overheat pre-alarm signal is input from a multi-function digital input terminal.</p>	<p>An external overheat condition exists connected to one of the multi-function input terminals S3, S4, S5, S6 or S7.</p>	<p>Check for an external condition.</p>
			<p>Verify the program parameters H1-01 thru H1-05.</p>
<p>OH3 Motor Overheat 1 (Flashing)</p>	<p>Motor Overheating Alarm The Drive stops or continues operation according to the setting of L1-03.</p>	<p>Overheating of motor</p>	<p>Recheck the cycle time and the size of the load.</p>
			<p>Recheck the accel/decel time (C1-01 and C1-02).</p>
			<p>Recheck the V/F pattern (E1-01 thru E1-13).</p>
			<p>Recheck the motor rated current value (E2-01).</p>
			<p>Check the digital operator connector.</p>
			<p>Verify the setting of o2-06.</p>

Table 6.2 Alarm Displays and Processing (Continued)

Digital Operator Display	Description	Cause	Corrective Action
OV DC Bus Overvolt (Flashing)	DC Bus Overvoltage 208-240VAC: Trip point is $\geq 400\text{Vdc}$ 480VAC: Trip point is $\geq 800\text{Vdc}$	High input voltage at R/L1, S/L2 and T/L3.	Check the input circuit and reduce the input power to within specifications.
		The deceleration time is set too short.	Extend the time in C1-02.
		Power factor correction capacitors are being used on the input to the Drive.	Remove the power factor correction capacitors.
UL3 Undertorq Det 1 (Flashing)	Undertorque Detection 1 Drive output current < L6-02 for more than the time set in L6-03	Motor is underloaded.	Ensure the values in L6-02 and L6-03 are appropriate. Check application/machine status to eliminate fault.
UV DC Bus Undervolt (Flashing)	DC Bus Undervoltage The DC bus voltage is \leq L2-05 208-240VAC: Trip point is $\leq 190\text{Vdc}$ 480VAC: Trip point is $\leq 380\text{Vdc}$	Low input voltage at R/L1, S/L2 and T/L3.	Check the input circuit and increase the input power to within specifications.
		The acceleration time is set too short.	Extend the time in C1-01.
		Voltage fluctuation of the input power is too large.	Check the input voltage.
UV2 CTL PS Undervolt	Control Power Supply Undervoltage of the control circuit when running	External load connected pulling down the Drive power supplies.	Cycle power off and on to the Drive. Repair or replace the Power PCB/ Gate Drive PCB.
UV3 MC Answerback	Soft Charge Circuit Fault The pre-charge contactor opened while the Drive was running.	Contacts on the soft charge contactor are dirty and the soft charge contactor does not function mechanically.	Cycle power off and on to the Drive. Check the condition of the soft charge contactor.

◆ Operator Programming Errors (OPE)

An Operator Programming Error (OPE) occurs when an inapplicable parameter is set or an individual parameter setting is inappropriate.

The Drive does not operate until the parameter is set correctly. (Alarm output and fault contact do not operate.)

If an OPE occurs, change the appropriate parameter by checking the cause shown in Table 6.3.

Digital Operator Display	Description	Cause	Corrective Action
OPE01 kVA Selection t	Drive kVA setting error	The control board was replaced and the kVA parameter is set incorrectly.	Enter the correct kVA setting (o2-04) by referring to the Drive model number in Appendix B.
OPE02 Limit	Constant data out of range	Parameter set above the allowable range	Verify the program settings.
OPE03 Terminal	Multi-function input selection fault	Duplicate functions are selected, up/down commands or trim control increase/decrease are not set simultaneously. Speed search from maximum frequency and set frequency are set simultaneously.	Verify program settings (H1-01~H1-05).
OPE05 Sequence Select	Run command is selected through serial communication at 2CN but option board is not installed.	Serial communication option board is not installed, option board is installed incorrectly. The run command selection parameter B1-02 is set to 3 and option board is not installed.	Verify that the board is installed. Remove power to the Drive and connect the option board once more.
OPE10 V/f Ptrn Setting	V/f data setting fault	V/f parameter settings are not set correctly.	Check parameters (E1-04 ~ E1-11). A minimum frequency/voltage value may be set higher than the maximum frequency/voltage.
OPE11 CarrFrq/On-Delay	Carrier frequency data setting fault Carrier frequency proportional gain C6-05 > 6 and C6-04 > C6-03. Upper/lower limit error of C6-03 to 5.0kHz	Parameter setting incorrect.	Check the program settings and correct the errors.
ERR EEPROM R/W Err	It does not match at EEPROM write.	<ul style="list-style-type: none"> Power supply is turned OFF. Parameter is reset repeatedly. 	<ul style="list-style-type: none"> Cycle power off and on to Drive. Do a factory initialization (A1-03).

◆ Auto-Tuning Faults

Auto-tuning faults are shown below. When the following faults are detected, the fault is displayed on the digital operator and the motor coasts to a stop during operation. The fault contact is not activated.

Digital Operator Display	Probable Cause	Corrective Action
Er - 01 Fault	<ul style="list-style-type: none"> • There is an error in the data input for autotuning. • There is an error in the relationship between the motor output and the motor rated current. 	<ul style="list-style-type: none"> • Check input data. • Check Drive and motor capacity. • Check motor rated current.
Er - 02 Minor Fault	A minor fault is detected during auto-tuning.	<ul style="list-style-type: none"> • Check input data. • Check wirings and around the machine. • Check the load.
Er - 03 STOP key	The STOP key is pressed during auto-tuning, and the auto-tuning is interrupted.	–
Er - 04 Resistance	Auto-tuning is not completed within the specified time. The auto-tuning result became other than the parameter set range.	<ul style="list-style-type: none"> • Check input data. • Check motor wiring. • If a motor and a machine are connected, disconnect the motor from the machine.
Er - 12 I-det. Circuit	<ul style="list-style-type: none"> • Current flow exceeded the motor rated current. • Current detection value symbol was reversed. • Any of U/T1, V/T2, and W/T3 has open-phase. 	<ul style="list-style-type: none"> • Check current detection circuit, wiring and mounting procedure.
Er - 13 Leakage Inductance Fault	Auto-tuning did not finish within the set time. Tuning result became other than the parameter setting range.	<ul style="list-style-type: none"> • Check motor wiring.
End - 3 Data Invalid	Rated current set value is set too high.	<ul style="list-style-type: none"> • Check input data (especially, motor output current and motor rated current value).

◆ Digital Operator COPY Function Faults

These faults can occur during the operator COPY function. Fault content is displayed on the operator. An error during the COPY function does not activate the fault contact output or alarm output.

Function	Digital Operator Display	Probable Causes	Corrective Action
READ Function	PRE READ IMPOSSIBLE	o3-01 was set to 1 to write a parameter when the Digital Operator was write-protected (o3-02 = 0).	Set o3-02 to 1 to enable writing parameters with the Digital Operator.
	IFE READ DATA ERROR	The read data length does not agree. The write data is incorrect.	<ul style="list-style-type: none"> • Repeat the Read. • Check the Digital Operator cable. • Replace digital operator.
	RDE DATA ERROR	An attempted write of a parameter to EEPROM on the Digital Operator failed.	<ul style="list-style-type: none"> • A low Inverter voltage has been detected. • Repeat the read. • Replace Digital Operator.
COPY Function	CPE ID UNMATCHED	The Drive product code or software number is different.	Use COPY function for the same product code and software number.
	VAE INV. KVA UNMATCH	The capacity of the Drive being copied and the capacity in the Digital Operator are different.	Use COPY function for the same Drive capacity.
	CRE CONTROL UNMATCHED	The control method of the Drive being copied and the control method in the Digital Operator are different.	Use the COPY function for the same control method.
	CYE COPY ERROR	The parameter written to the Drive was compared with the parameter in the Digital Operator and they were different.	COPY retest.
	CSE SUM CHECK ERROR	The checksum in the Drive parameter area was compared with the checksum in the Digital Operator parameter area and they were different.	Retry the copy.
Verify Function	VYE VERIFY ERROR	The set value of the digital operator and the Drive do not match.	Retry Verify function. After COPY is retested, verify it is retested.

Drive Troubleshooting

Due to parameter setting errors, faulty wiring, etc., the Drive and motor may not operate as expected when the system is started up. If this occurs, use this section as a reference and apply the appropriate measures.

If a fault is displayed on the digital operator, refer to Fault Detection, Table 6.1.

◆ If Parameter Cannot Be Set

Use the following information if a Drive parameter cannot be set.

■ The display does not change when the INCREASE and DECREASE keys are pressed.

The following causes are possible.

The Drive is operating (Drive mode).

There are some parameters that cannot be set during operation. Remove the run command and then set the parameters.

Parameter write enable is input.

This occurs when "parameter write enable" (set value: 1B) is set for a multi-function digital input terminal (H1-01 to H1-05). If the parameter write enable input is OFF, the parameters cannot be changed. Turn it ON and then set the parameters.

Passwords do not match. (Only when a password is set.)

If the parameter A1-04 (Password) and A1-05 (Password Setting) numbers are different, the parameters for the initialize mode cannot be changed. Enter the correct password in A1-04.

If you cannot remember the password, display A1-05 (Password Setting) by pressing the Shift/Reset Key and the MENU Key simultaneously while in the A1-04 display. Reset the password and input the reset password in parameter A1-04.

■ OPE01 through OPE11 is displayed.

The set value for the parameter is wrong. Refer to Operator Programming Errors in this chapter and correct the setting.

■ CPF00 or CPF01 is displayed.

This is a Digital Operator communications error. The connection between the Digital Operator and the Drive may be faulty. Remove the Digital Operator and then re-install it.

◆ If the Motor Does Not Operate

Use the following information if the motor does not operate.

■ Ensure the digital operator is securely connected to the Drive.

■ The motor does not operate when the HAND key on the Digital Operator is pressed.

The following causes are possible:

The Speed Command (Frequency Reference) is too low.

If the Speed Command (frequency reference) is set below the frequency set in E1-09 (Minimum Output Frequency), the Drive will not operate.

Raise the Speed Command to at least the minimum output frequency.

■ The motor does not operate when an external run command is input.

The following causes are possible.

The Drive is not in Drive mode.

If the Drive is not in Drive mode, it will remain in ready status and will not start. Press the MENU key once and press the DATA/ENTER key. The Drive is now in Drive mode.

The Speed Command is too low.

If the Speed Command is set below the frequency set in E1-09 (Minimum Output Frequency), the Drive will not operate. Raise the Speed Command to at least the minimum output frequency.

■ **The motor stops during acceleration or when a load is connected.**

The load may be too high. The Drive has a stall prevention function and an automatic torque boost function, but the motor responsiveness limit may be exceeded if acceleration is too rapid or if the load is too great. Lengthen the acceleration time (CI-01) or reduce the load. Also consider increasing the motor size.

■ **The motor only rotates in one direction.**

"Reverse run prohibited" may be selected. If b1-04 (Prohibition of Reverse Operation) is set to 1 (reverse run prohibited), the Drive will not receive reverse run commands. This is the default to use both forward and reverse operation, set b1-04 to 0, and operate in Auto mode.

◆ **The Direction of the Motor Rotation is Reversed**

If the motor rotates in the wrong direction, the motor output wiring is incorrect. When the Drive U/T1, V/T2, and W/T3 terminals are properly connected to the motor, the motor operates in a forward direction when a forward run command is received. The forward direction depends on the manufacturer and the motor type, so be sure to check the specifications.

The direction of rotation can be reversed by switching any two wires among U/T1, V/T2, and W/T3.

◆ **If the Motor Does Not Put Out Torque or If Acceleration is Slow**

Use the following information if the motor does not output torque or if acceleration is too slow.

■ **The stall prevention level during acceleration is too low.**

If the value set for L3-02 (Stall Prevention Acceleration Level) is too low, the acceleration time will be too long. Check to be sure that the set value is suitable.

■ **The stall prevention level during running is too low.**

If the value set for L3-06 (Stall Prevention Level during Running) is too low, the motor speed and torque will be limited. Check to be sure that the set value is suitable.

◆ **If the Motor Operates at a Higher Speed Than the Speed Command**

Use the following information if the motor operates at a higher speed than the Speed Command.

■ **A signal is being input to the Speed Command (current) terminal A2.**

If a preset frequency reference is selected, the preset reference takes priority over the normal reference.

If the PI mode of operation is enabled, the Drive output frequency will change to regulate the process variable to the desired setpoint. Then, the Drive speed may go to maximum.

◆ If the Motor Overheats

Take the following steps if the motor overheats.

■ The load is too high.

If the motor load is too high and the motor is used when the effective torque exceeds the motor's rated torque, the motor will overheat. Reduce the load amount by either reducing the load or increasing the acceleration/deceleration times. Also consider increasing the motor size.

■ The ambient temperature is too high.

The motor rating is determined by a particular ambient operating temperature range. The motor will overheat if it is run continuously at the rated torque in an environment where the maximum ambient operating temperature rating is exceeded. Lower the motor's ambient temperature to within its acceptable range.

■ The withstand voltage between the motor phases is insufficient.

When the motor is connected to the Drive output, Voltage surges are generated by standing waves that can occur with certain combinations of Drive carrier frequency and motor cable length. Normally the maximum surge voltage is three times the Drive's input power supply voltage (i.e., 1200VAC for a 480VAC). Be sure to use a motor with a withstand voltage between the motor phases that is greater than the maximum surge voltage. In particular, when using a 480VAC Drive, use an inverter-duty (NEMA MG1, Parts 30 & 31) motor. Motor protection filter can also be an effective measure.

◆ If Peripheral Devices Like PLCs or Others are Influenced by Starting or Running Drive

■ If noise is generated by Drive switching, implement the following countermeasures:

1. Change the Drive's Carrier Frequency Selection (C6-02) to lower the carrier frequency. This will help to reduce the amount of internal switching.
2. Install an Input Noise Filter at the Drive's input power terminals.
3. Use metal conduit. Electric waves can be shielded by metal, so encase the Drive and power wires in metal.
4. Ground the Drive and motor.
5. Separate main circuit wiring from control wiring.

◆ If the Ground Fault Interrupter Operates When the Drive is Run

The Drive performs internal switching, so there is a certain amount of leakage current. This may cause an external ground fault interrupter to operate and cut off the power supply. Whenever possible, use a ground fault interrupter with a high leakage detection level (i.e., a sensitivity current of 200 mA or greater per unit, with an operating time of 0.1 s or more), or one that incorporates high frequency countermeasures (i.e., one designed for use with Drives). It will also help to change the Drive's Carrier Frequency Selection (C6-02) to lower the carrier frequency. In addition, remember that the leakage current increases as the cable is lengthened.

◆ If There is Mechanical Vibration

Use the following information when there is mechanical vibration.

■ The application is making unusual sounds.

The following causes are possible.

There may be resonance between the mechanical system's natural frequency and the carrier frequency.

This is characterized by the motor running with no noise generation, but the machinery vibrates with a high-pitched whine. To prevent this type of resonance, adjust the carrier frequency with parameters C6-02 to C6-05.

There may be resonance between an applications characteristic frequency and the output frequency of the Drive.

To prevent this from occurring, use the jump frequency functions in parameters d3-01 to d3-04, or have the driven motor and load balanced to reduce vibration.

■ Oscillation and hunting are occurring with V/f control.

The gain adjustment may be insufficient. Reset the gain to a more effective level by raising the value of C4-02 (Torque Compensation Primary Delay Time Parameter) and then lowering the setting of n1-02 (Hunting Prevention Gain).

■ Oscillation and hunting are occurring with PI control.

If there is oscillation or hunting during PI control, check the oscillation cycle and individually adjust P and I parameters.

- Disable integral (I) control
- Reduce the proportional gain (P) until hunting stops
- Reintroduce the integral function, starting with long integral time values, to eliminate the P offset

◆ If the Motor Rotates Even When Drive Output is Stopped

If the motor rotates even when the Drive is stopped, the DC injection braking may be insufficient. If the motor continues operating at low speed, without completely stopping after a stop has been executed, it means that the DC injection braking is not decelerating the motor enough. Adjust the DC injection braking as follows:

- Increase the parameter b2-04 (DC Injection Braking (initial excitation) Time at Stop) setting.
- Increase the parameter b2-02 (DC Injection Braking Current) setting.

◆ If Zero Volts is Detected When a Motor is Started, or Stalls

Generation of 0 V (main circuit voltage) and stalling can occur if a motor is turning when it is started and the DC injection braking is insufficient.

This can be prevented by slowing motor rotation by DC injection braking before starting. Increase parameter b2-03 (DC injection braking time at start) setting.

◆ If Output Frequency Does Not Rise to Frequency Reference

Use the following information if the output frequency does not rise to the Speed Command.

■ The Speed Command is within the jump frequency range.

When the jump frequency function is used, the output frequency does not change within the jump frequency range. Check to be sure that the Jump Frequency (parameters d3-01 to d3-03) and Jump Frequency Width (parameter d3-04) settings are suitable.

■ The frequency reference upper limit has been reached.

The output frequency upper limit is determined by the following formula:

$$\text{Freq Ref Upper Limit} = \text{Maximum Output Frequency (E1-04)} \times \text{Frequency Reference Upper Limit (d2-01)} / 100$$

Check to be sure that the parameter E1-04 and d2-01 settings are suitable.

Drive Main Circuit Test Procedure

WARNING

Prior to removing any protective cover or wiring any part of the Drive, remove all power sources, including main input power and control circuit power. Wait a minimum of 5 minutes after power removal, before removing any cover. The charge lamp located within the Drive should be off prior to working inside. Even if the charge lamp is off, one must measure the AC input, output, and DC Bus potential to insure safe levels prior to resuming work. Failure to adhere to this warning may result in personal injury or death.

Before attempting any troubleshooting checks, make sure that the three-phase power is disconnected and locked out. With power removed from the unit, the DC bus capacitors will stay charged for several minutes. The Charge LED in the Drive will glow red until the DC bus voltage is below 10Vdc. To ensure that the DC bus is completely discharged, measure between the positive and negative bus with a DC voltmeter set to the highest scale.

Table 6.6 Main Circuit Test Procedure

Check	Procedure
Measure DC Bus Voltage	<ol style="list-style-type: none"> 1. Set the digital multi-meter to its highest VDC scale. 2. Measure between ⊕ 1 and (-) for the following check: Place the positive (red) meter lead on ⊕ 1. Place the negative (black) meter lead on (-). 3. If the measured voltage is < 10Vdc, it is safe to work inside the Drive. If not, wait until the DC Bus has completely discharged.
Input Diodes (D1-D12 or Q1)	<p>The input diodes rectify or transform the three-phase input AC voltage into a DC voltage.</p> <ol style="list-style-type: none"> 1. Set a digital multi-meter to the Diode Check setting. 2. Place the positive (red) meter lead on terminal R/L1. Place the negative (black) meter lead on terminal ⊕ 1. Expected reading is about 0.5 Volts. 3. Place the positive (red) meter lead on terminal S/L2. Place the negative (black) meter lead on terminal ⊕ 1. Expected reading is about 0.5 Volts. 4. Place the positive (red) meter lead on terminal T/L3. Place the negative (black) meter lead on terminal ⊕ 1. Expected reading is about 0.5 Volts. 5. Place the positive (red) meter lead on terminal R/L1. Place the negative (black) meter lead on terminal (-). Expected reading is OL displayed. 6. Place the positive (red) meter lead on terminal S/L2. Place the negative (black) meter lead on terminal (-). Expected reading is OL displayed. 7. Place the positive (red) meter lead on terminal T/L3. Place the negative (black) meter lead on terminal (-). Expected reading is OL displayed. 8. Place the positive (red) meter lead on terminal (-). Place the negative (black) meter lead on terminal R/L1. Expected reading is about 0.5 Volts. 9. Place the positive (red) meter lead on terminal (-). Place the negative (black) meter lead on terminal S/L2. Expected reading is about 0.5 Volts. 10. Place the positive (red) meter lead on terminal (-). Place the negative (black) meter lead on terminal T/L3. Expected reading is about 0.5 Volts.

Table 6.6 Main Circuit Test Procedure (Continued)

Check	Procedure
<p>Input Diodes (D1-D12 or Q1)</p>	<ol style="list-style-type: none"> 11. Place the positive (red) meter lead on terminal ⊕ 1. Place the negative (black) meter lead on terminal R/L1. Expected reading is OL displayed. 12. Place the positive (red) meter lead on terminal ⊕ 1. Place the negative (black) meter lead on terminal S/L2. Expected reading is OL displayed. 13. Place the positive (red) meter lead on terminal ⊕ 1. Place the negative (black) meter lead on terminal T/L3. Expected reading is OL displayed.
<p>Soft Charge Resistor Check (R1, R2, 6PCB)</p>	<p>The soft charge resistor works in conjunction with the soft charge contactor to slowly charge the DC bus capacitors to minimize the inrush current when power is applied to the Drive.</p> <ol style="list-style-type: none"> 1. Conduct a visual inspection. Check for physical damage. 2. Set a digital multi-meter to the R x 1 scale. 3. If the resistor is damaged, the measured value will be infinite ohms.
<p>Soft Charge Contactor (K1)</p>	<p>The purpose of the soft charge contactor is to bypass the soft charge resistor after the DC bus voltage has reached its normal operating level.</p> <ol style="list-style-type: none"> 1. Conduct a visual inspection. Check for physical damage. 2. Set a digital multi-meter to the R x 1 scale. 3. On Drives with a board-mounted contactor, verify that each contact resistance measures infinite ohms. 4. On Drives without a board-mounted contactor, press the plunger in, and verify that each contact measures zero ohms. 5. On Drives without a board-mounted contactor, release the plunger, and verify that the resistance is the ohmic value of the soft charge resistor. 6. On Drives with a board-mounted contactor, verify that the contactor coil measures about 300 ohms. The coil can be tested by applying the appropriate voltage to verify the contacts change states. 7. On Drives without a board-mounted contactor, verify that the 230VAC contactor coil measures about 175 ohms. The coil can be tested by applying the appropriate voltage to verify the contacts change states. 8. On Drives without a board-mounted contactor, verify that the 24Vdc auxiliary coil measures about 2.2M ohms. The coil can be tested by applying the appropriate voltage to verify the contacts change states.
<p>DC Bus Fuse (F1)</p>	<p>The DC bus fuse is located in the negative portion of the DC Bus. The DC bus fuse is used to protect the main circuit components if the output transistors short. If the DC bus fuse is open, at least one of the output transistors has failed. When a transistor fails, there is a short between the positive and negative portions of the DC Bus. The DC bus fuse does not protect the transistors, but protects the rest of the main circuit from the high current present during a short. <i>Never replace the DC bus fuse without first checking all of the output transistors.</i></p> <ol style="list-style-type: none"> 1. Set a digital multi-meter to the R x 1 scale. 2. Place one lead of the multi-meter on one side of the fuse and place the other lead of the multi-meter on the other side of the fuse. 3. If the fuse is good, the measured value will be zero ohms. If the fuse is bad, the measured value will be infinite ohms.

Table 6.6 Main Circuit Test Procedure (Continued)

Check	Procedure
<p>Output Transistors (Q1-Q12)</p>	<p>The output transistors are used to switch the DC bus voltage to allow current to flow to the motor.</p> <ol style="list-style-type: none"> 1. Set a digital multi-meter to the Diode Check setting. 2. Place the positive (red) meter lead on terminal U/T1. Place the negative (black) meter lead on terminal ⊕ 1. Expected reading is about 0.5 Volts. 3. Place the positive (red) meter lead on terminal V/T2. Place the negative (black) meter lead on terminal ⊕ 1. Expected reading is about 0.5 Volts. 4. Place the positive (red) meter lead on terminal W/T3. Place the negative (black) meter lead on terminal ⊕ 1. Expected reading is about 0.5 Volts. 5. Place the positive (red) meter lead on terminal U/T1. Place the negative (black) meter lead on terminal (-). Expected reading is OL displayed. 6. Place the positive (red) meter lead on terminal V/T2. Place the negative (black) meter lead on terminal (-). Expected reading is OL displayed. 7. Place the positive (red) meter lead on terminal W/T3. Place the negative (black) meter lead on terminal (-). Expected reading is OL displayed. 8. Place the positive (red) meter lead on terminal (-). Place the negative (black) meter lead on terminal U/T1. Expected reading is about 0.5 Volts. 9. Place the positive (red) meter lead on terminal (-). Place the negative (black) meter lead on terminal V/T2. Expected reading is about 0.5 Volts. 10. Place the positive (red) meter lead on terminal (-). Place the negative (black) meter lead on terminal W/T3. Expected reading is about 0.5 Volts. 11. Place the positive (red) meter lead on terminal ⊕ 1. Place the negative (black) meter lead on terminal U/T1. Expected reading is OL displayed. 12. Place the positive (red) meter lead on terminal ⊕ 1. Place the negative (black) meter lead on terminal V/T2. Expected reading is OL displayed. 13. Place the positive (red) meter lead on terminal ⊕ 1. Place the negative (black) meter lead on terminal W/T3. Expected reading is OL displayed.
<p>Control Power Fuse</p>	<p>All Drives have a Control Power Fuse. The fuse is located on either the Power PCB (3PCB) or the Gate Drive PCB (3PCB). The Control Power Fuse protects the primary switching mode power supply.</p> <ol style="list-style-type: none"> 1. Set a digital multi-meter to the R x 1 scale. 2. Place one lead of the multi-meter on one side of the fuse and place the other lead of the multi-meter on the other side of the fuse. 3. If the fuse is good, the measured value will be zero ohms. If the fuse is bad, the measured value will be infinite ohms.

Table 6.6 Main Circuit Test Procedure (Continued)

Check	Procedure
<p>24Vdc Cooling Fans (Heat Sink & Internal)</p>	<p>The Heat Sink & Internal Cooling Fans cool the heat sink as well as the output transistor modules of the Drive.</p> <ol style="list-style-type: none"> 1. Conduct a visual inspection to ensure the fan turns freely. 2. If there is no physical evidence that the fan is bad, the fan motor can be checked with a digital mutli-meter. 3. Set the digital multi-meter to the R x 1 scale. 4. Measure across the fan motor terminals. If zero ohms are measured, conclude that the fan motor is shorted. If infinite ohms are measured, conclude that the fan motor is burned open. 5. If the fan is not working, then disconnect the fan and apply 24Vdc to the fan to test the motor.
<p>230/240VAC Cooling Fans (Heat Sink)</p>	<p>The Heat Sink Cooling Fans cool the heat sink to remove heat from the Drive.</p> <ol style="list-style-type: none"> 1. Conduct a visual inspection to ensure the fan turns freely. 2. If there is no physical evidence that the fan is bad, the motor can be checked with a digital mutli-meter. 3. Set a digital multi-meter to the R x 1 scale. 4. Measure across the fan motor terminals. If the fan motor is good, the measured value should be about 500 ohms. If zero ohms are measured, conclude that the fan motor is shorted. If infinite ohms are measured, conclude that the fan motor is burned open. If the fan is not working, then disconnect the fan and apply 230/240VAC to the fan to test the motor.
<p>Cooling Fan Fuse</p>	<p>Large Drive units contain a Cooling Fan Fuse. It is located on either the Gate Drive Board (3PCB) or the Tap Change Board (8PCB). If the Cooling Fan Fuse is open, then the 230/240VAC cooling fans may be defective.</p> <ol style="list-style-type: none"> 1. Set a digital multi-meter to the R x 1 scale. 2. Place one lead of the multi-meter on one side of the fuse and place the other lead of the multi-meter on the other side of the fuse. 3. If the fuse is good, the measured value will be zero ohms. If the fuse is bad, the measured value will be infinite ohms.

Drive Date Stamp Information

This information is used to determine when a Drive was built to see if it is within its warranty period. The date stamp is located on the lower right side of the Drive.

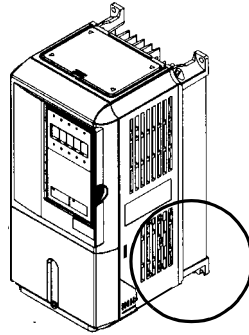
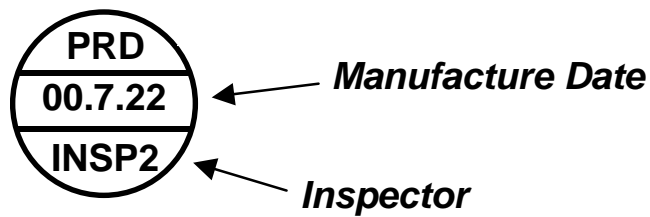

Fig 6.1 Date Stamp Location



Chapter 7

Maintenance

This chapter describes basic maintenance and inspection of the Drive and Bypass unit. Please refer to these instructions to ensure that the Drive receives the proper maintenance to maintain overall performance.

Maintenance	2
Periodic Inspection	2
Preventive Maintenance	3
Replacing Control Panel indicating lights or selector switches ..	4
Replacing The Relay Controller PCB:	5
Drive Heatsink Cooling Fan Replacement	6
Removing and Mounting the Drive Control Terminal Card	8
Removing and Replacing the Drive in a Bypass Unit	9
Drive Replacement	9

P7B Maintenance

◆ Periodic Inspection

Check the following items during periodic maintenance.

- The motor should not be vibrating or making unusual noises.
- There should be no abnormal heat generation from the Drive and Bypass or motor.
- The ambient temperature should be within the Drive and Bypass specification of -10°C to 40°C (14°F to 104°F).
- The output current value shown in parameter U1-03 should not be higher than the motor rated current for an extended period of time.
- The cooling fan in the Drive and Bypass should be operating normally.

Always turn OFF the input power before beginning inspection. Confirm that the digital operator and indicator lights on the front panel have all turned OFF, and then wait an additional five minutes before beginning the inspection. Be sure not to touch terminals immediately after the power has been turned off. Doing so can result in electric shock. Please refer to Warnings on page i.

Item	Inspection	Corrective Action
External terminals, mounting bolts, connectors, etc.	Are all screws and bolts tight?	Tighten loose screws and bolts firmly.
	Are connectors tight?	Reconnect the loose connectors.
Cooling fins	Are the fins dirty or dusty?	Clean off any dirt and dust with an air gun using clean and dry air at a pressure between 55-85 psi.
Bypass Operator Interface PCB Bypass Relay Controller PCB Control PCB Terminal PCB Power PCB Gate Drive PCBs	Is there any conductive dirt or oil mist on the PCBs?	Clean off any dirt and dust with an air gun using clean and dry air at a pressure between 55-85 psi. Replace the boards if they cannot be made clean.
Contactors Input Diodes Output Transistors or IPMs	Is there any conductive dirt or oil mist on the modules or components?	Clean off any dirt and dust with an air gun using clean and dry air at a pressure between 55-85 psi.
DC bus capacitors	Are there any irregularities, such as discoloration or odor?	Replace the capacitors or Drive.

Apply power to the Drive and Bypass, then conduct the following inspection.

Item	Inspection	Corrective Action
Cooling fan(s)	Is there any abnormal noise or vibration, or has the total operating time exceeded 20,000 hours. Check U1-40 for elapsed cooling fan operation time.	Replace Cooling Fan.

◆ Preventive Maintenance

Inspection Points	Item	Check Points	Every 3-6 Months	Yearly
General	Environment	Ambient Temperature	✓	
		Humidity	✓	
		Dust	✓	
Harmful Gas		✓		
Oil Mist		✓		
	Equipment	Abnormal vibration or noise	✓	
	AC Power Supply	Main circuit & control voltage	✓	
AC Power Circuit & Devices	Conductors & Wire Connections	Loose lugs, screws & wires		✓
		Hot spots on parts		✓
		Corrosion		✓
		Bent conductors		✓
		Breakage, cracking or discoloration		✓
		Check spacing		✓
	Transformers & Reactors	Discoloration or Noise	✓	
	Terminal Blocks	Loose, damaged		✓
	DC Bus Capacitors	Leakage		✓
		Ruptures, broken, expansion		✓
		Capacitance & insulation resistance		✓
	Relays & Contactors	Noisy		✓
		Contact discoloration		✓
	Soft Charge Resistors	Cracked		✓
		Discoloration		✓
Control Circuits	Operation	Speed reference voltage/current		✓
		I/O contact operation		✓
		Relay logic		
Cooling System	Cooling Fans/Fins & Heatsink	Abnormal fan noise	✓	
		Loose connectors		✓
		Free of accumulation	✓	
Keypad/Front Panel Display	Digital Operator and Front Panel	LEDs	✓	
		Monitor display values	✓	
		Key and selector switch functionality		✓
		Clean		✓

If the Drive is used under the following conditions, it may be necessary to inspect more often:

- High ambient temperatures, humidity or altitudes above 3,300 feet
- Frequent starting and stopping
- Fluctuations of the AC power supply or load
- Excessive vibration and/or shock loading
- Poor environment, including dust, metal particles, salt, sulfuric acid, chlorine

◆ Replacing Control Panel indicating lights or selector switches

Control panel pilot lights are modular, replaceable LEDs with a MTBF of 100,000 hours. LED type indicating lights are provided to improve the reliability well beyond that of incandescent bulbs.

To remove and replace the LEDs, remove 9 screws from the “Bypass Operator Interface PCB A3” located on the inside of the enclosure door mounted Operator Panel.

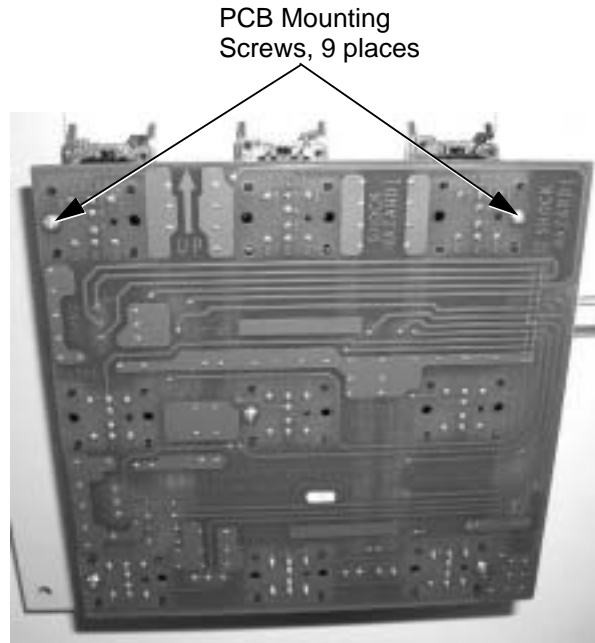

Fig 7.1 Removing PCB A3

PCB A3 will then lift off, exposing the LEDs and selector switch assemblies. Remove the ribbon cable connection from CN203 as well as marking and disconnecting the terminations from CN204, CN205, CN206 and CN207, if required, to gain access to the LED side of the circuit board A3.

To replace an individual LED, slide a small blade screwdriver beside the LED module and the retaining tabs on the socket that is soldered to the circuit board, see Figure 7.2.

Twist the screwdriver just sufficiently to release the retainers while “rocking” the LED module in the socket. Care must be exercised to avoid breaking off the delicate retaining tabs. If retaining tabs break off, then the complete PCB A3 should be replaced (see appendix F for part numbers).

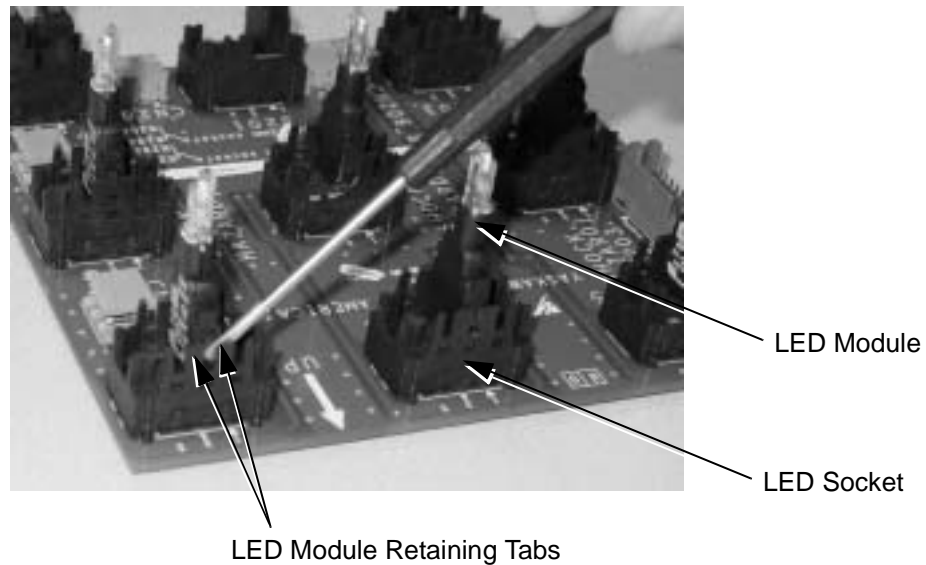

Fig 7.2 Removing an LED

The new LED module (see appendix F for part numbers) is simply pushed firmly into the same location on the socket until the retainers snap into place. Then reassemble the PCB A3 to the operator panel on the inside of the enclosure door, using the 9 screws previously removed.

This procedure is also employed to replace the Selector Switch modules on the “Bypass Operator Interface PCB A3”.

◆ Replacing The Relay Controller PCB:

The Bypass controller relays are not individually replaceable, the “Bypass Relay Controller PCB A2” assembly must be replaced (see appendix F for part numbers). The “Bypass Relay Controller PCB A2” is located on the left hand side of the wall mount enclosure, adjacent to the door hinge.

To remove PCB A2, disconnect the ribbon cable connectors at CN102 A, CN102 B and CN103. Mark and disconnect the wires from TB CN102 C as well as marking and disconnecting all field wiring from terminal block TB1. Remove the 5 nuts securing the circuit board to the side wall of the enclosure, lift out and replace the “Bypass Relay Controller PCB A2” assembly with a new one (see appendix F for part numbers).

◆ Drive Heatsink Cooling Fan Replacement

■ Drive Models CIMR-__ __20P4 thru 2018 (25 HP@208V/240V) and 40P4 thru 4018 (30 HP@480V)

IMPORTANT

If the Drive is mounted with the heatsink external to the enclosure, as it is in Bypass units, the cooling fan can only be replaced by removing the Drive from the enclosure. See "Removing and Replacing the Drive" in this chapter.

A cooling fan is attached to the bottom of the Drive.

If the Drive is installed using the mounting holes on the back of the Drive heatsink, the cooling fan can be replaced without removing the Drive from the enclosure panel.

■ Removing the Drive Heatsink Cooling Fan

1. Always turn OFF the input power before removing and installing the heatsink cooling fan.
2. Press in on the right and left sides of the fan cover in the direction of arrows "1" and then pull the fan out in the direction of arrow "2".
3. Pull out the cable connected to the fan from the fan cover and disconnect the power connector. See Figure 7.3.
4. Open the fan cover on the left and right sides in the direction of arrows "3" and remove the fan cover from the fan.

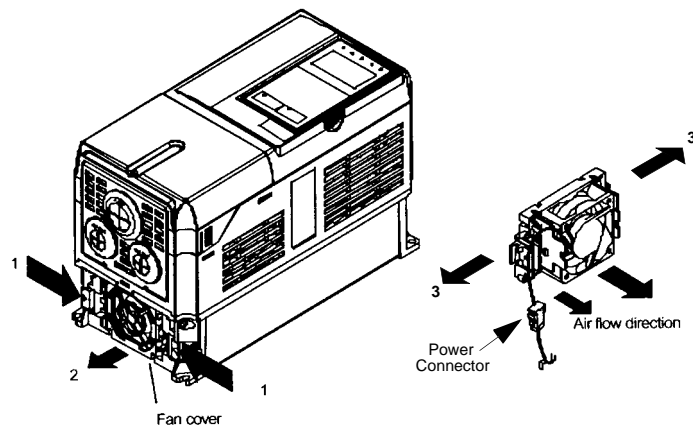

Fig 7.3 Cooling Fan Replacement Procedure

■ Installing the Drive Heatsink Cooling Fan

1. Attach the fan cover to the cooling fan. Be sure that the air flow direction indicated by the arrows above faces into the Drive.
2. Connect the power connector securely and place the power connector and cable into the fan cover.
3. Mount the fan cover on the Drive. Be sure that the tabs on the sides of the fan cover click into place on the Drive.

■ **Drive Models CIMR-____2022 thru 2110 (30 HP and above @ 208V/240V) and 4030 thru 4300 (40 HP and above @ 480V)**

A cooling fan assembly is attached to the top inside the Drive. The cooling fan assembly includes the heat sink cooling fans and the internal cooling fan. The cooling fan(s) can be replaced without removing the Drive from the enclosure panel.

■ **Removing the Drive Cooling Fan Assembly**

1. Always turn OFF the input power before removing and installing the heatsink cooling fan assembly.
2. Remove the terminal cover, Drive cover, Digital Operator, and front cover from the front of the Drive.
3. Remove the Control PCB bracket (if necessary) to which the cards are mounted. Remove all cables connected to the Control PCB and remove the cooling fan power connector from the fan board (13 PCB) positioned near the top of the Drive.
4. Remove the cooling fan power connectors from the gate Drive board (3PCB) positioned at the back of the Drive.
5. Remove the fan assembly screws and pull out the fan assembly from the Drive.
6. Remove the cooling fan(s) from the fan assembly.

■ **Mounting the Drive Cooling Fan Assembly**

After attaching a new cooling fan, reverse the above procedure to attach all of the components.

When attaching the cooling fan to the mounting bracket, be sure that the air flow goes toward the top of the Drive.

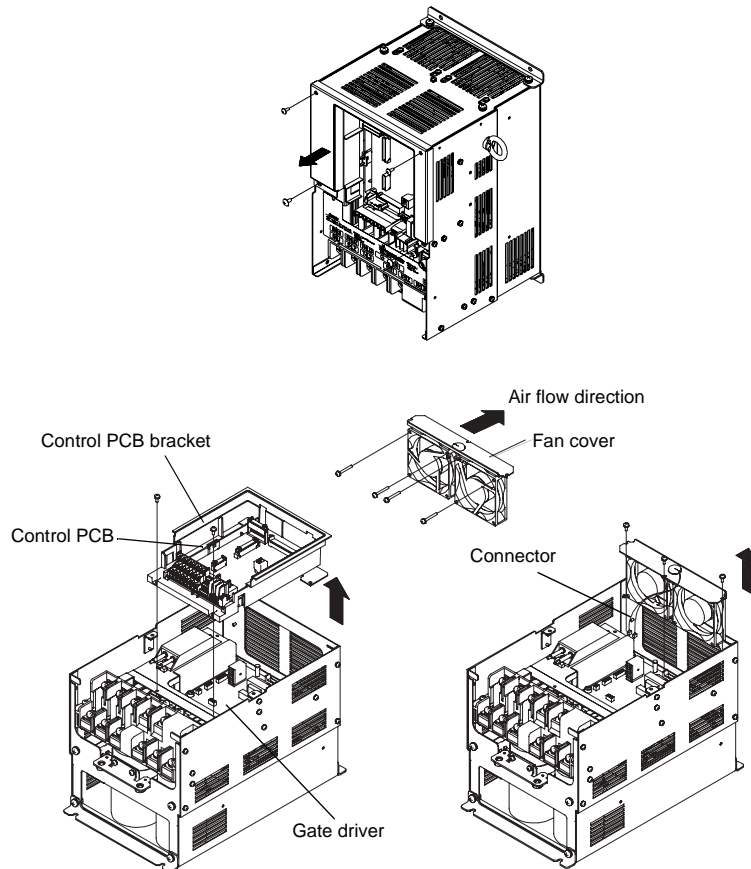

Fig 7.4 Cooling Fan Assembly Replacement Procedure

◆ Removing and Mounting the Drive Control Terminal Card

The terminal card can be removed and mounted without disconnecting the control wiring.

IMPORTANT

Always confirm that input power is removed and the Charge LED is not lit before removing or mounting the terminal card.

■ Removing the Drive Terminal Card

1. Remove the terminal cover on the Drive.
2. Remove the Digital Operator and front cover on the Drive.
3. Remove the wires connected to FE and NC on the terminal card.
4. Loosen the mounting screws on the left and right sides of the terminal card until they are free. It is not necessary to remove the mounting screws completely. They are captive and self-rising.
5. Pull the terminal card out in the direction of the block arrow.

■ Mounting the Drive Terminal Card

Reverse the removal procedure to mount the terminal card.

Confirm that the terminal card and the Control PCB properly meet at connector CN8 before insertion.

The connector pins may be bent if the terminal card is forced into place, possibly preventing correct Drive operation.

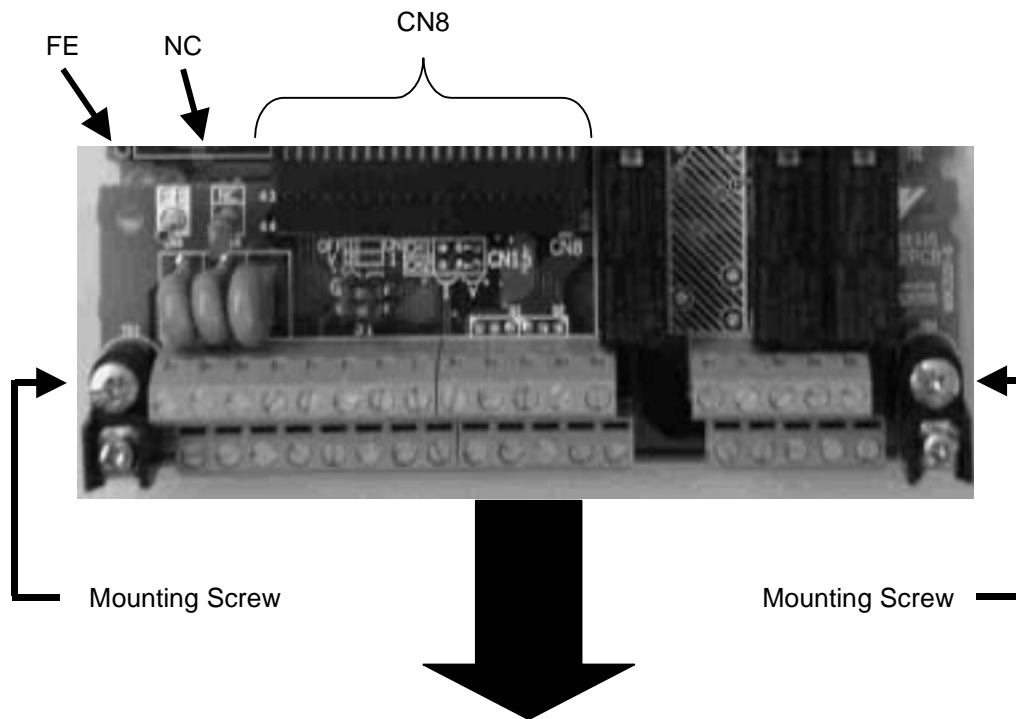

Fig 7.5 Terminal Card Removal Procedure

Removing and Replacing the Drive in a Bypass Unit

◆ Drive Replacement

If possible, save the existing drive programming by copying it to the memory in the keypad/operator via parameter o3-01.

When it has been determined that a Drive fault requires a Drive replacement (see Chapter 6), there are several steps required before the Bypass will be operable again. First, a new Drive must be ordered. Begin by determining the model number Drive that is in the Bypass assembly.

Drive Model Number: _____

Warranty status determines whom you should contact to obtain a new Drive.

For a Bypass unit that is still under warranty, begin by contacting Yaskawa Technical Support: 1-800-YASKAWA (927-5292), dial 2 for Inverter and Drive Products, then 5 for technical support. Technical support may also be reached through e-mail at DriveSupport@yaskawa.com.

A Yaskawa distributor should be contacted to replace a Drive that is no longer under warranty.

When the Drive arrives, verify that the Drive is the correct model number.

■ Removing the Drive

Before installing the new Drive, the old Drive must be removed from the Bypass assembly. As a safety precaution, disconnect the AC power line coming into the main Bypass circuit breaker to ensure that no power is in the Bypass unit.

Check the Drive DC Bus voltage to be sure it is at a safe level before working inside the Bypass enclosure. DC Bus voltage can be monitored by the CHARGE status indicator LED, near the power terminals. Be sure the LED is extinguished before proceeding. Another method is to measure the DC voltage across terminals “+1” and “-” on the power terminal block.

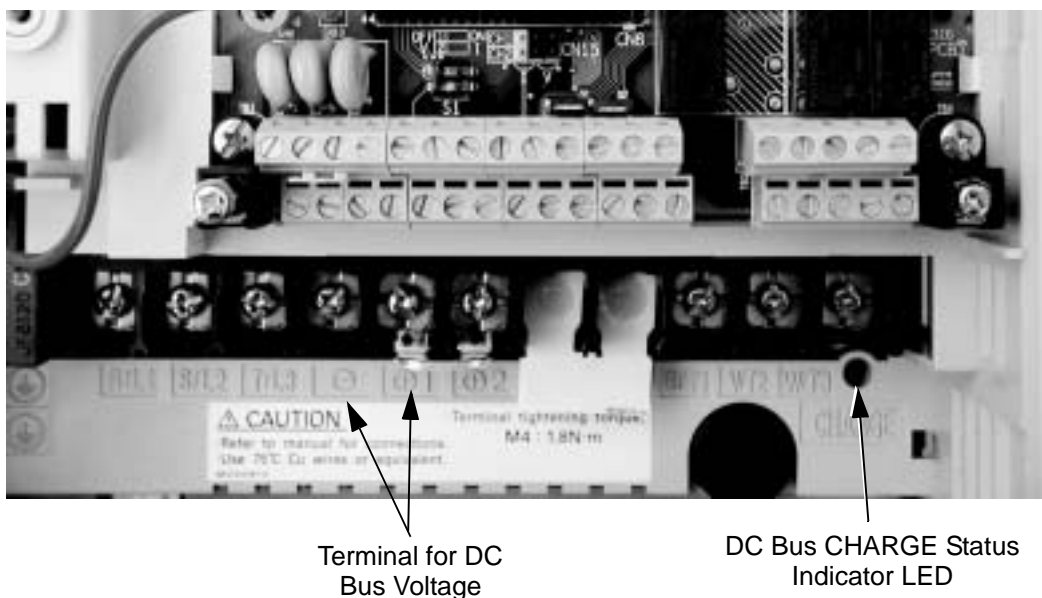

Fig 7.6 Drive Power Terminal Block

Disconnect the cable from the Drive to the front panel mounted Digital Operator at the Drive end of the cable.

If a LonWorks option card is present, leave all the wires connected to the option card, disconnect the option card ground wire at the Drive end and remove the option card from the Drive.

Leave the field control wiring connected to the removable control terminal card and remove the control terminal card from the Drive. Two captive screws on either side of the terminal card must be loosened, the ground wire removed from terminal FE, and the terminal card must be separated from the control circuit board by sliding the terminal card off its Connector (CN8). Do this carefully by pulling down evenly on both sides of the terminal card. See also page 7-9 for detailed instructions.

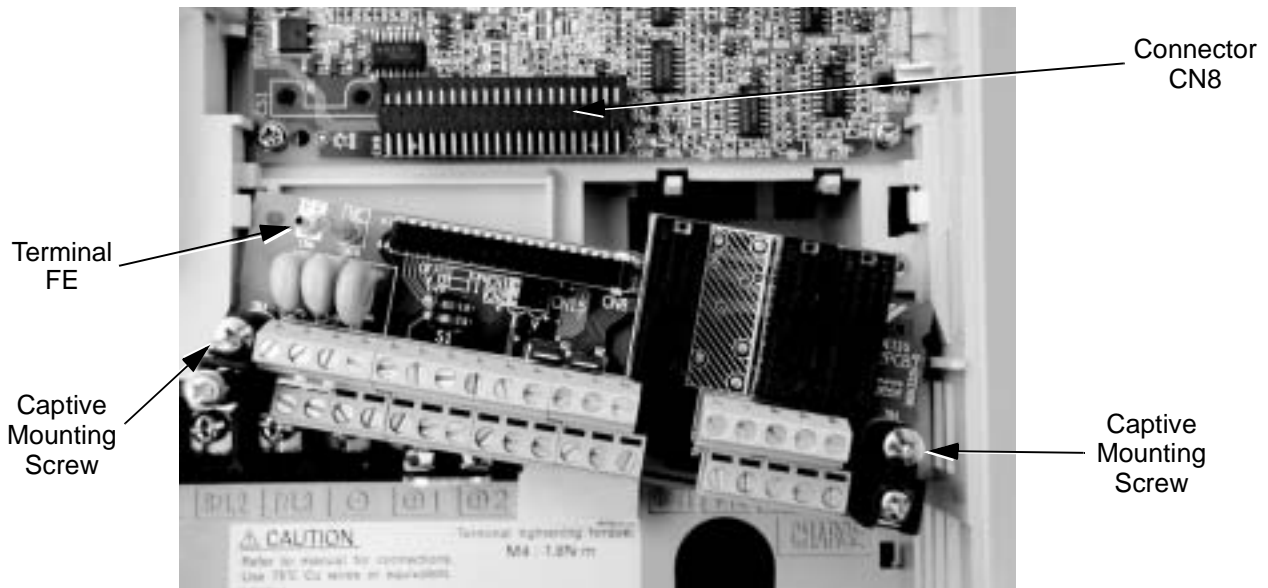

Fig 7.7 Removable Control Terminal Card

The power terminal block for the three phase input and output power connections is not removable. All connections to the power terminal block must be removed. Do not overlook the Drive ground wire. It is behind other wiring and will probably be removed last. Observe the wire and terminal markings for all power wires, to ensure correct re-wiring to the new Drive. The wires are labeled from the factory, but re-label any wires where labels may no longer be legible. Refer to *Chapter 2 Electrical Installation* and the schematic diagram that was shipped with the original Bypass unit.

Once all wiring has been disconnected from the Drive, the Drive is ready to be removed from the enclosure. Drives located in Bypass units are mounted differently than stand alone drives. A Drive in a Bypass unit is mounted such that the heat sink is external to the enclosure. Mounting brackets are located on the top and bottom of the Drive, between the Drive and the Drive's heat sink. These brackets are bolted to the reinforced Bypass back panel with the heat sink projecting through an opening in the back panel and reinforcing frame.



Fig 7.8 Drive Top Mounting Bracket

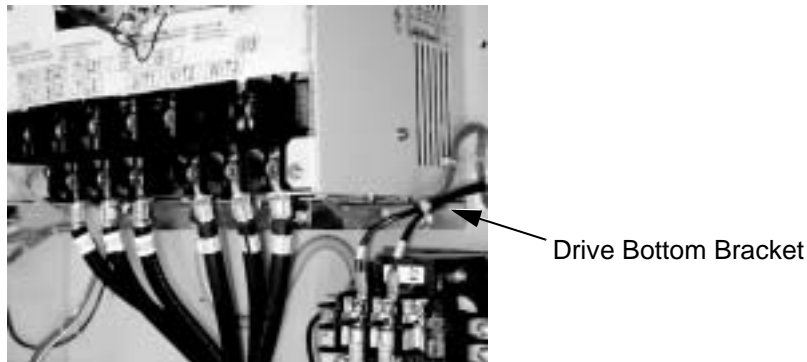

Fig 7.9 Drive Bottom Mounting Bracket

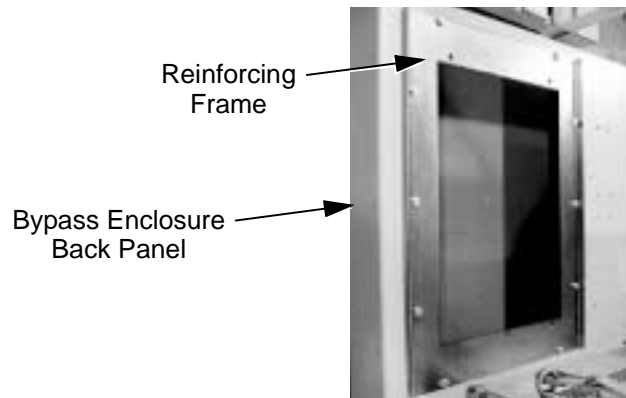

Fig 7.10 Back Panel and Reinforcing Frame

To free the Drive, remove the bolts from the Drive mounting brackets (remove the bottom first). When free, pull the Drive through the front of the Bypass enclosure by guiding the heat sink back through the opening in the back panel.

With the Drive out of the Bypass assembly, remove the mounting brackets from the old Drive by removing the bolts affixing the mounting brackets to the Drive. Attach the mounting brackets to the new Drive using the bolts from the old Drive.

■ Installing the Replacement Drive

Place the new Drive into the Bypass by sliding the heat sink through the opening in the rear of the Bypass enclosure. Line up the holes on the mounting brackets with the holes in the reinforcing frame of the Bypass assembly. Use the mounting bolts previously removed to re-affix the Drive to the Bypass back panel.

When the new Drive has been mounted in the Bypass enclosure, reconnect all power wiring and verify by checking the Bypass schematic.

Re-mount the control terminal card to the Drive by sliding the terminal card into the connector (CN8) on the control circuit board. Re-fasten the captive screws to the control PCB. Consult page 7-9 for detailed instructions.

Re-mount any option card, and re-connect all wiring from the option card to the Drive. Be sure to re-connect the ground wire to the Drive.

With the Drive replacement complete, return power to the Bypass unit. Locate the start-up procedure for the Bypass in Chapter 4 and follow the complete start-up procedure.

■ Programming the Replacement Drive

Replacement drives come from the factory with standard factory default parameter settings. They are not “Bypass ready” and the parameters in the replacement Drive will need to be modified for Bypass compatibility.

Several approaches to this may be available:

1. The digital operator/keypad from the old Drive may contain a copy of the parameter settings for this application. See parameter o3-01 in Chapter 5 for instructions.
2. The customer may have a file of parameter settings for the PC software “DriveWizard” which can be used to download these values to the Drive. Information and instructions for DriveWizard are available at www.drives.com.
3. Page 2 of the Bypass Schematic has a table of Drive “Factory Parameter Settings” for Bypass applications of drives. The Bypass schematic was delivered as part of the original Bypass assembly and is re-produced in Chapter 2 of this manual. These settings can be manually entered into the new Drive after setting the access level in parameter A1-01 to advanced (“2: Advanced Level”).

Using one of these methods, load the Drive with the Bypass “factory default” settings and verify correct Bypass operation.

Appendix A

Parameters

This appendix lists all the parameter numbers and names, along with a description of each. Also, below the parameter name in bold type is the abbreviated name as it appears on the digital operator display/keypad.

Parameter List	2
Monitor List	26
Fault Trace List	28
Fault History List	29

Parameter List

Table 1: Parameter List

Parameter No.	Parameter Name Digital Operator Display	Description	Setting Range	Factory Setting	Menu Location
Initialization					
A1-00 ◆	Language Selection Select Language	Language selection for digital operator display. 0: English 1: Japanese 2: Deutsch 3: Francais 4: Italiano 5: Espanol 6: Portugues *Not returned to factory setting by initialization	0 to 6	0	Quick Setting
A1-01 ◆	Access Level Selection Access Level	This setting determines which parameters are accessible. 0: Operation Only 1: User Level 2: Advanced Level	0 to 2	2	Programming
A1-03	Initialize Parameters Init Parameters	Used to return all parameters to their factory or user setting. 0: No Initialize 1110: User Initialize (The user must set their own parameter default values and then parameter o2-03 must be set to "1" to save them. If the parameter values are changed after o2-03 is set to "1", the user default values can be restored by setting A1-03 to 1110.) 2220: 2-Wire Initial 3330: 3-Wire Initial	0 to 3330	0	Programming
A1-04	Password 1 Enter Password	When the value set into A1-04 does NOT match the value set into A1-05, parameters A1-01 thru A1-03 and A2-01 thru A2-32 cannot be changed. All other parameters as determined by A1-01 can be changed. Parameter A1-05 can be accessed by pressing the MENU key while holding the RESET key.	0 to 9999	0	Programming
A1-05	Password 2 Select Password		0 to 9999	0	Programming
User Parameters					
A2-01	User Parameter 1 User Param 1	Selects the parameters to be available in the User Access Level (A1-01 = 1). These are the only parameters accessible for the user level. These parameters are not related to the User Initialize function.	b1-01 to o3-02	—	Programming
A2-02	User Parameter 2 User Param 2			—	Programming
A2-03	User Parameter 3 User Param 3			—	Programming
A2-04	User Parameter 4 User Param 4			—	Programming
A2-05	User Parameter 5 User Param 5			—	Programming
A2-06	User Parameter 6 User Param 6			—	Programming
◆Denotes that parameter can be changed when the Drive is running.					

Table 1: Parameter List (Continued)

Parameter No.	Parameter Name Digital Operator Display	Description	Setting Range	Factory Setting	Menu Location
A2-07	User Parameter 7 User Param 7	Selects the parameters to be available in the User Access Level (A1-01 = 1). These are the only parameters accessible for the user level. These parameters are not related to the User Initialize function.	b1-01 to o3-02	—	Programming
A2-08	User Parameter 8 User Param 8			—	Programming
A2-09	User Parameter 9 User Param 9			—	Programming
A2-10	User Parameter 10 User Param 10			—	Programming
A2-11	User Parameter 11 User Param 11			—	Programming
A2-12	User Parameter 12 User Param 12			—	Programming
A2-13	User Parameter 13 User Param 13			—	Programming
A2-14	User Parameter 14 User Param 14			—	Programming
A2-15	User Parameter 15 User Param 15			—	Programming
A2-16	User Parameter 16 User Param 16			—	Programming
A2-17	User Parameter 17 User Param 17			—	Programming
A2-18	User Parameter 18 User Param 18			—	Programming
A2-19	User Parameter 19 User Param 19			—	Programming
A2-20	User Parameter 20 User Param 20			—	Programming
A2-21	User Parameter 21 User Param 21			—	Programming
A2-22	User Parameter 22 User Param 22			—	Programming
A2-23	User Parameter 23 User Param 23			—	Programming
A2-24	User Parameter 24 User Param 24			—	Programming
A2-25	User Parameter 25 User Param 25			—	Programming
A2-26	User Parameter 26 User Param 26			—	Programming
A2-27	User Parameter 27 User Param 27			—	Programming
A2-28	User Parameter 28 User Param 28			—	Programming
A2-29	User Parameter 29 User Param 29			—	Programming
A2-30	User Parameter 30 User Param 30			—	Programming
A2-31	User Parameter 31 User Param 31			—	Programming
A2-32	User Parameter 32 User Param 32			—	Programming

Table 1: Parameter List (Continued)

Parameter No.	Parameter Name Digital Operator Display	Description	Setting Range	Factory Setting	Menu Location
Sequence					
b1-01	Frequency Reference Selection Reference Source	Selects the speed command (frequency reference) input source. 0: Operator - Digital preset speed d1-01 1: Terminals - Analog Input Terminal A1 (or Terminal A2 see parameter H3-13) 2: Serial Com - RS-485 terminals R+, R-, S+ and S- 3: Option PCB - Option board connected at 2CN	0 to 3	1	Quick Setting
b1-02	Run Command Selection Run Source	Selects the run command input source. 0: Operator - "Hand" and "Off" keys on digital operator 1: Terminals - Contact Closure on Terminal S1 2: Serial Com - RS-485 terminals R+, R-, S+ and S- 3: Option PCB - Option board connected at 2CN	0 to 3	1	Quick Setting
b1-03	Stopping Method Selection Stopping Method	Selects the stopping method when the run command is removed. 0: Ramp to Stop 1: Coast to Stop 2: DC Injection to Stop 3: Coast w/Timer (A new run command is ignored if input before the time in C1-02 expires.)	0 to 3	0	Quick Setting
b1-04	Reverse Operation Selection Reverse Oper	Determines the forward rotation of the motor, and if reverse operation is disabled. 0: Reverse Enabled 1: Reverse Disabled 2: Exchange Phase - Change direction of forward motor rotation. 3: ExchgPhs, Rev Dsbl - Change direction of forward motor rotation and disable reverse operation.	0 to 3	1	Quick Setting
b1-07	Local/Remote Run Selection LOC/REM RUN Sel	0: Cycle Extern RUN - If the run command is closed when switching from hand(local) mode to auto(remote) mode, the Drive will not run. 1: Accept Extrn RUN - If the run command is closed when switching from hand(local) mode to auto(remote) mode, the Drive WILL run.	0 or 1	0	Programming
b1-08	Run Command Selection During Program RUN CMD at PRG	0: Disabled - Run command accepted only in the operation menu. 1: Enabled - Run command accepted in all menus (except when b1-02 = 0).	0 or 1	0	Programming
b1-11	Drive Delay Time Setting Wait to Run Time	After a run command, Drive output will start after this delay time.	0 to 600	0sec	Programming
b1-12	Hand Frequency Reference Selection HAND Fref Source	Selects the speed command input source in hand mode. 0: Operator - Digital preset speed d1-01 1: Terminals - Analog Input Terminal A1 (or Terminal A2 see parameter H3-13)	0 or 1	0	Programming
DC Braking					
b2-01	DC Injection Braking Start Frequency DCInj Start Freq	Sets the frequency at which DC injection braking starts when ramp to stop (b1-03 = 0) is selected. If b2-01 < E1-09, DC Injection braking starts at E1-09.	0.0 to 10.0	0.5Hz	Programming
b2-02	DC Injection Braking Current DCInj Current	Selects the DC injection braking current as a percentage of the Drive rated current.	0 to 100	50%	Programming
b2-03	DC Injection Braking Time at Start DCInj Time @ Start	Sets the time length of DC injection braking at start in units of 1 second.	0.00 to 10.00	0.00sec	Programming
b2-04	DC Injection Braking Time at Stop DCInj Time @ Stop	When b1-03 = 2 actual DC Injection time is calculated as follows: b2-04 * 10 * Output Frequency / E1-04. When b1-03 = 0, this parameter determines the amount of time DC Injection is applied to the motor at the end of the decel ramp. This should be set to a minimum of 0.50 seconds when using HSB. This will activate DC injection during the final portion of HSB and help ensure that the motor stops completely.	0.00 to 10.00	0.00sec	Programming
b2-09	Motor Pre-Heat Current Preheat Current	Motor Pre-heat current in % of Drive rated current. This is used to keep the motor warm to prevent condensation and is used in conjunction with a digital input (data = 60).	0 to 100	0%	Programming

Table 1: Parameter List (Continued)

Parameter No.	Parameter Name Digital Operator Display	Description	Setting Range	Factory Setting	Menu Location
Speed Search					
b3-01	Speed Search Selection SpdSrch at Start	Enables/disables and selects the speed search function at start. 0: SpdsrchF Disable - Speed search at start is disabled (estimated speed method is used at other times) 1: SpdsrchF Enable - Speed search is enabled (estimated speed method) 2: SpdsrchI Disable - Speed search at start is disabled (current detection method is used at other times) 3: SpdsrchI Enable - Speed search is enabled (current detection method) Estimated Speed Method: Actual motor speed and direction is estimated, then the motor is ramped from that speed to the commanded speed. Current Detection Method: Current level is monitored while output frequency is ramped down.	0 to 3	2	Programming
b3-02	Speed Search Deactivation Current SpdSrch Current	Used only when b3-01 = 3. Sets the speed search operation current as a percentage of Drive rated current.	0 to 200	120%	Programming
b3-03	Speed Search Deceleration Time SpdSrch Dec Time	Used only when b3-01 = 3. Sets the deceleration time during speed search.	0.1 to 10.0	2.0sec	Programming
b3-05	Speed Search Delay Time Search Delay	Delays the speed search operation after a momentary power loss to allow time for an external output contactor to re-energize.	0.0 to 20.0sec	0.2sec	Programming
b3-14	Bidirectional Speed Search Selection Bidir Search Sel	0: Disabled 1: Enabled	0 or 1	1	Programming
Delay Timers					
b4-01	Timer Function ON-Delay Time Delay-ON Timer	Used in conjunction with a multi-function digital input and a multi-function digital output. This sets the amount of time between when the digital input is closed, and the digital output is energized.	0.0 to 3000.0	0.0sec	Programming
b4-02	Timer Function OFF-Delay Time Delay-OFF Timer	Used in conjunction with a multi-function digital input and a multi-function digital output. This sets the amount of time the output stays energized after the digital input is opened.	0.0 to 3000.0	0.0sec	Programming
PI Control					
b5-01	PI Mode Setting PI Mode	This parameter enables / disables the closed loop (PI) controller. 0: Disabled 1: Enabled (commanded speed becomes PI setpoint) 3: Fref+PI	0, 1, 3	0	Quick Setting
b5-02 ◆	Proportional Gain Setting P Gain	Sets the proportional gain of the PI controller.	0.00 to 25.00	2.00	Quick Setting
b5-03 ◆	Integral Time Setting PI I Time	Sets the integral time for the PI controller. A setting of zero disables integral control.	0.0 to 360.0	5.0sec	Quick Setting
b5-04 ◆	Integral Limit Setting PI I Limit	Sets the maximum output possible from the integrator. Set as a % of fmax.	0.0 to 100.0	100%	Quick Setting
b5-06 ◆	PI Output Limit PI Limit	Sets the maximum output possible from the entire PI controller. Set as a % of fmax.	0.00 to 100.0	100.0%	Quick Setting
b5-07 ◆	PI Offset Adjustment PI Offset	Sets the amount of offset of the output of the PI controller. Set as a % of fmax. The PI Offset Adjustment parameter has two different uses. Parameter b5-07 serves different functions depending on whether it is used on a standard PI loop or a Differential PI loop. 1: Parameter b5-07 causes an offset to be applied to the output of the PI function in a non-Differential PI loop. Every time the PI output is updated, the offset is summed with the PI output. This can be used to artificially kick-start a slow starting PI loop. 2: If the Drive is configured for Differential PI Regulation (H3-09=16), then the PI Offset is the targeted maintained differential between the signal measured on analog input A1 and the signal measured on analog input A2.	-100.0 to +100.0	0.0%	Quick Setting
b5-08 ◆	PI Primary Delay Time Constant PI Delay Time	Sets the amount of time for a filter on the output of the PI controller.	0.00 to 10.00	0.00sec	Quick Setting
b5-09	PI Output Level Selection Output Level Sel	Determines whether the PI controller will be direct or reverse acting. 0: Normal Output (direct acting) 1: Reverse Output (reverse acting)	0 or 1	0	Quick Setting
◆Denotes that parameter can be changed when the Drive is running.					

Table 1: Parameter List (Continued)

Parameter No.	Parameter Name Digital Operator Display	Description	Setting Range	Factory Setting	Menu Location
b5-10	PI Output Gain Setting Output Gain	Sets the output gain of the PI controller.	0.0 to 25.0	1.0	Quick Setting
b5-11	PI Output Reverse Selection Output Rev Sel	0: 0 limit (when PI output goes negative Drive stops) 1: Reverse (when PI goes negative Drive reverses) 0 limit automatic when reverse prohibit is selected using b1-04	0 or 1	0	Quick Setting
b5-12	PI Feedback Reference Missing Detection Selection Fb los Det Sel	0: Disabled 1: Alarm 2: Fault	0 to 2	0	Quick Setting
b5-13	PI Feedback Loss Detection Level Fb los Det Lvl	Sets the PI feedback loss detection level as a percentage of maximum frequency (E1-04).	0 to 100	0%	Quick Setting
b5-14	PI Feedback Loss Detection Time Fb los Det Time	Sets the PI feedback loss detection delay time in terms of seconds.	0.0 to 25.5	1.0sec	Quick Setting
b5-15	Sleep Function Start Level Sleep Level	Sets the sleep function start frequency.	0.0 to 200.0	0.0Hz	Quick Setting
b5-16	Sleep Delay Time Sleep Time	Sets the sleep function delay time in terms of seconds.	0.0 to 25.5	0.0sec	Quick Setting
b5-17	PI Accel/Decel Time PI Acc/Dec Time	Applies an accel/decel time to the PI setpoint reference.	0.0 to 25.5	0.0sec	Quick Setting
b5-18	PI Setpoint Selection PI Setpoint Sel	0: Disabled 1: Enabled	0 or 1	0	Quick Setting
b5-19	PI Setpoint Value PI Setpoint	*Depends on b5-20.	0.00 to 100.00	0.00%	Quick Setting
b5-20	PI Setpoint Display Scaling Setpoint Scaling	Set display/setting unit of b5-19.	0 to 39999	1	Quick Setting
b5-21	PI Sleep Input Source PI Sleep Source	Input Source Selection for Sleep function Mode. 0: PI Input 1: PI Setpoint 2: Snooze	0 to 2	1	Quick Setting
b5-22 ◆	PI Snooze Level Snooze Level	Sets the PI snooze function start level as a percentage of maximum frequency (E1-04).	0 to 100	0%	Quick Setting
b5-23	PI Snooze Delay Time Snooze Delay Time	Sets the PI snooze function delay time in terms of seconds.	0 to 3600	0sec	Quick Setting
b5-24	PI Snooze Deactivation Level Wake-Up Level	When the PI feedback drops below this level, normal PI operation starts again. Set as a percentage of maximum frequency (E1-04).	0 to 100	0%	Quick Setting
b5-25	PI Setpoint Boost Setting Setpoint Boost	Temporary increase of PI setpoint to create an overshoot of the intended PI setpoint.	0 to 100	0%	Quick Setting
b5-26	PI Maximum Boost Time Max Boost Time	Sets a time limitation for reaching temporarily boosted PI setpoint (intended PI setpoint + b5-25).	0 to 3600	0sec	Quick Setting
b5-27	PI Snooze Feedback Level Snooze Feedback	PI snooze mode will be activated when PI feedback is above this level. Set as a percentage of maximum frequency (E1-04).	0 to 100	60%	Quick Setting
b5-28	PI Feedback Square Root Function Selection PI Feedback SqRt	0: Disabled 1: Enabled	0 or 1	0	Quick Setting
b5-29	PI Square Root Gain PI Fb SqRt Gain	A multiplier applied to the square root of the feedback.	0.00 to 2.00	1.00	Quick Setting
b5-30	Output Square Root Monitor Selection PI Out Moni SqRt	0: Disabled 1: Enabled	0 or 1	0	Quick Setting

◆Denotes that parameter can be changed when the Drive is running.

Table 1: Parameter List (Continued)

Parameter No.	Parameter Name Digital Operator Display	Description	Setting Range	Factory Setting	Menu Location
Energy Saving					
b8-01	Energy Saving Control Selection Energy Save Sel	Energy Savings function enable/disable selection 0: Disabled 1: Enabled	0 or 1	0	Quick Setting
b8-04	Energy Saving Coefficient Value Energy Save COEF	Used to fine-tune the energy savings function.	0.0 to 655.00	kVA Dependent	Programming
b8-05	Power Detection Filter Time kW Filter Time		0 to 2000	20ms	Programming
b8-06	Search Operation Voltage Limit Search V Limit		0 to 100	0%	Programming
Accel / Decel					
C1-01 ◆	Acceleration Time 1 Accel Time 1	Sets the time to accelerate from zero to maximum frequency.	0.0 to 6000.0	30.0sec	Quick Setting
C1-02 ◆	Deceleration Time 1 Decel Time 1	Sets the time to decelerate from maximum frequency to zero.		30.0sec	Quick Setting
C1-03 ◆	Acceleration Time 2 Accel Time 2	Sets the time to accelerate from zero to maximum frequency when selected via a multi-function input.		30.0sec	Programming
C1-04 ◆	Deceleration Time 2 Decel Time 2	Sets the time to decelerate from maximum frequency to zero when selected via a multi-function input.		30.0sec	Programming
C1-09	Fast Stop Time Fast Stop Time	Sets the time to decelerate from maximum frequency to zero for the "Fast Stop" function.	0.0 to 6000.0	10.0sec	Programming
C1-11	Accel/Decel Switch Frequency Acc/Dec SW Freq	Sets the frequency for automatic switching of accel / decel times. Fout < C1-11: Accel/Decel Time 2 Fout >= C1-11: Accel/Decel Time 1 Multi-function input "Multi-Acc/Dec 1" has priority over C1-11.	0.0 to 200.0	0.0Hz	Programming
S-Curve Acc/Dec					
C2-01	S-Curve Characteristic at Accel Start SCrv Acc @ Start	<p>S-curve is used to further soften the starting ramp. The longer the S-curve time, the softer the starting ramp.</p>	0.00 to 2.50	0.20sec	Programming
C2-02	S-Curve Characteristic at Accel End SCrv Acc @ End		0.00 to 2.50	0.20sec	Programming
◆Denotes that parameter can be changed when the Drive is running.					

Table 1: Parameter List (Continued)

Parameter No.	Parameter Name Digital Operator Display	Description	Setting Range	Factory Setting	Menu Location
Torque Comp					
C4-01 ◆	Torque Compensation Gain Torq Comp Gain	This parameter helps to produce better starting torque. It determines the amount of torque or voltage boost based upon motor current and motor resistance.	0.00 to 2.50	1.00	Programming
C4-02	Torque Compensation Primary Delay Time Torq Comp Time	This parameter adjusts a filter on the output of the torque compensation function. Increase to add torque stability, decrease to improve torque response.	0 to 10000	200ms	Programming
Carrier Freq					
C6-02	Carrier Frequency Selection CarrierFreq Sel	Carrier frequency sets the number of pulses per second of the output voltage waveform. 0: Low Noise (Carrier frequency is randomly modulated for lower audible noise) 1: Fc = 2.0 kHz 2: Fc = 5.0 kHz 3: Fc = 8.0 kHz 4: Fc = 10.0 kHz 5: Fc = 12.5 kHz 6: Fc = 15.0 kHz F: Program (Determined by the settings of C6-03 thru C6-05)	0 to F	kVA Dependent	Programming
C6-03	Carrier Frequency Upper Limit CarrierFreq Max	Maximum carrier frequency allowed when C6-02 = F.	0.4 to 15.0 kHz	kVA Dependent	Programming
C6-04	Carrier Frequency Lower Limit CarrierFreq Min	Minimum carrier frequency allowed when C6-02 = F.	0.4 to 15.0 kHz	kVA Dependent	Programming
C6-05	Carrier Frequency Proportional Gain CarrierFreq Gain	Sets the relationship of output frequency to carrier frequency when C6-02 = F.	0 to 99	0	Programming
Preset Reference					
d1-01 ◆	Frequency Reference 1 Reference 1	Digital preset speed command 1. Used when b1-01 = 0 and when in "hand" mode. Setting units are affected by o1-03.	0.00 to E1-04 Value	0.00Hz	Programming
d1-02 ◆	Frequency Reference 2 Reference 2	Digital preset speed command 2. Selected via multi-function input terminals. Setting units are affected by o1-03.		0.00Hz	Programming
d1-03 ◆	Frequency Reference 3 Reference 3	Digital preset speed command 3. Selected via multi-function input terminals. Setting units are affected by o1-03.		0.00Hz	Programming
d1-04 ◆	Frequency Reference 4 Reference 4	Digital preset speed command 4. Selected via multi-function input terminals. Setting units are affected by o1-03.		0.00Hz	Programming
d1-17 ◆	Jog Frequency Reference Jog Reference	Speed command used when a jog is selected via multi-function input terminals. Setting units are affected by o1-03.	0.00 to E1-04 Value	6.00Hz	Programming
◆Denotes that parameter can be changed when the Drive is running.					

Table 1: Parameter List (Continued)

Parameter No.	Parameter Name Digital Operator Display	Description	Setting Range	Factory Setting	Menu Location
Reference Limits					
d2-01	Frequency Reference Upper Limit Ref Upper Limit	Determines maximum speed command, set as a percentage of parameter E1-04. If speed command is above this value, actual Drive speed will be limited to this value. This parameter applies to all speed command sources.	0.0 to 110.0	100.0%	Quick Setting
d2-02	Frequency Reference Lower Limit Ref Lower Limit	Determines minimum speed command, set as a percentage of parameter E1-04. If speed command is below this value, actual Drive speed will be set to this value. This parameter applies to all speed command sources.	0.0 to 110.0	0.0%	Quick Setting
d2-03	Master Speed Reference Lower Limit Ref1 Lower Limit	Determines the minimum speed command, set as a percentage of parameter E1-04. If speed command is below this value, actual Drive speed will be set to this value. This parameter only applies to analog inputs A1 and A2.	0.0 to 110.0	0.0%	Programming
Jump Frequencies					
d3-01	Jump Frequency 1 Jump Freq 1	These parameters allow programming of up to three prohibited frequency points for eliminating problems with resonant vibration of the motor / machine. This feature does not actually eliminate the selected frequency values, but will accelerate and decelerate the motor through the prohibited bandwidth.	0.0 to 200.0	0.0Hz	Programming
d3-02	Jump Frequency 2 Jump Freq 2			0.0Hz	Programming
d3-03	Jump Frequency 3 Jump Freq 3			0.0Hz	Programming
d3-04	Jump Frequency Width Jump Bandwidth	This parameter determines the width of the deadband around each selected prohibited frequency point. A setting of "1.0" will result in a deadband of +/- 1.0 Hz.	0.0 to 20.0	1.0Hz	Programming
Sequence					
d4-01	MOP Ref Memory	0: Disabled 1: Enabled	0 or 1	0	Programming
d4-02	Trim Control Level Trim Control Lvl	Set the percentage of maximum speed to be added or subtracted via multi-function inputs.	0 to 100	10%	Programming

Table 1: Parameter List (Continued)

Parameter No.	Parameter Name Digital Operator Display	Description	Setting Range	Factory Setting	Menu Location	
			V/F Pattern			
E1-01	Input Voltage Setting Input Voltage	Set to the nominal voltage of the incoming line.	155 to 255.0 (240V) 310 to 510.0 (480V)	240V 480V	Quick Setting	
E1-03	V/F Pattern Selection V/F Selection	0: 50Hz 1: 60 Hz Saturation 2: 50 Hz Saturation 3: 72 Hz 4: 50 Hz VT1 5: 50 Hz VT2 6: 60 Hz VT1 7: 60 Hz VT2 8: 50 Hz HST1 9: 50 Hz HST2 A: 60 Hz HST1 B: 60 Hz HST2 C: 90 Hz D: 120 Hz E: 180 Hz F: Custom V/F FF: Custom w/o limit	0 to FF	F	Programming	
E1-04	Maximum Output Frequency Max Frequency	<p>Output voltage (V)</p>	0.0 to 200.0	60.0Hz	Programming	
E1-05	Maximum Output Voltage Max Voltage		0 to 255.0 (240V) 0 to 510.0 (480V)	240V 480V	Programming	
E1-06	Base Frequency Base Frequency		0.0 to 200.0	60.0Hz	Programming	
E1-07	Mid Output Frequency A Mid Frequency A		0.0 to 200.0	3.0Hz	Programming	
E1-08	Mid Output Voltage A Mid Voltage A		0 to 255.0 (240V) 0 to 510.0 (480V)	18.0VAC	Programming	
E1-09	Minimum Output Frequency Min Frequency		0.0 to 200.0	1.5Hz	Programming	
E1-10	Mid Output Voltage Min Voltage		To set V/f characteristics in a straight line, set the same values for E1-07 and E1-09. In this case, the setting for E1-08 will be disregarded. Always ensure that the four frequencies are set in the following manner: E1-04 (FMAX) ≥ E1-06 (FA) > E1-07 (FB) ≥ E1-09 (FMIN)	0 to 255.0 (240V) 0 to 510.0 (480V)	10.8VAC	Programming
E1-11	Mid Output Frequency B Mid Frequency B		0.0 to 200.0	0.0Hz	Programming	
E1-12	Mid Output Voltage B Mid Voltage B		Set only when V/f is finely adjusted at rated output range. Adjustment is not normally required.	0 to 255.0 (240V) 0 to 510.0 (480V)	0.0VAC	Programming
E1-13	Base Voltage Base Voltage		0 to 255.0 (240V) 0 to 510.0 (480V)	0.0VAC	Programming	

Table 1: Parameter List (Continued)

Parameter No.	Parameter Name Digital Operator Display	Description	Setting Range	Factory Setting	Menu Location
Motor Setup					
E2-01	Motor Rated Current Motor Rated FLA	Set to the motor nameplate full load amps.	10% to 200%	kVA Dependent	Quick Setting
E2-03	No-Load Current	Sets the magnetizing current of the motor.	kVA Dependent	kVA Dependent	Programming
E2-05	Motor Line-to-Line Resistance Term Resistance	Phase to phase motor resistance, normally set by the autotuning routine.	0.000 to 65.000	9.842Ω	Programming
Com OPT Setup					
F6-01	Operation Selection after Communication Error Com Bus Flt Sel	Sets the stopping method for option PCB communications error (BUS fault). Active only when a communications option PCB is installed and when b1-01 or b1-02 = 3. 0: Ramp to Stop 1: Coast to Stop 2: Fast-Stop 3: Alarm Only	0 to 3	1	Quick Setting
F6-02	Input Level of External Fault from Communication Option Card EFO Detection	0: Always detected 1: Detected only during operation	0 or 1	0	Programming
F6-03	Stopping Method for External Fault from Communication Option Card EFO Fault Action	0: Ramp to Stop 1: Coast to Stop 2: Fast-Stop 3: Alarm Only	0 to 3	1	Programming
F6-05	Current Monitor Display Unit Selection Current Unit Sel	0: A Display 1: 100%/8192 (Drive Rated Current)	0 or 1	0	Programming

Table 1: Parameter List (Continued)

Parameter No.	Parameter Name Digital Operator Display	Description	Setting Range	Factory Setting	Menu Location
Digital Inputs					
H1-01	Terminal S3 Function Selection Terminal S3 Sel	<p>0: 3-wire control FWD/REV selection for 3-wire sequence</p> <p>1: Local/Remote Sel Hand/Auto Selection - Closed = Hand, Open = Auto</p> <p>2: Option/Inv Sel Selects source of speed command and sequence Closed = Option Card, Open = b1-01 & b1-02</p> <p>3: Multi-Step Ref 1 Closed = speed command from d1-02 or Aux Terminal Open = speed command determined by b1-01</p> <p>4: Multi-Step Ref 2 Closed = speed command from d1-03 or d1-04 Open speed command determined by b1-01</p> <p>6: Jog Freq Ref Closed = speed command from d1-17 Open = speed command determined by b1-01</p> <p>7: Multi-Acc/Dec 1 Closed = Accel & Decel Ramps determined by C1-03 & C1-04 Open = Accel & Decel Ramps determined by C1-01 & C1-02</p> <p>8: Ext BaseBlk N.O. Closed = Output transistors forced off, Open = Normal operation</p> <p>9: Ext BaseBlk N.C. Closed = Normal Operation, Open = Output transistors forced off</p> <p>A: Acc/Dec RampHold Closed = Acceleration suspended and speed held, Open = Normal Operation</p> <p>C: Term A2 Enable Closed = Terminal A2 is active, Open = Terminal A2 is disabled</p> <p>F: Term Not Used Terminal has no effect</p> <p>10: MOP Increase Closed = Speed Command Increases, Open = Speed Command Held. Must be set in conjunction with MOP Decrease and b1-02 must be set to 1.</p> <p>11: MOP Decrease Closed = Speed Command Decreases, Open = Speed Command Held. Must be set in conjunction with MOP Increase and b1-02 must be set to 1.</p> <p style="text-align: center;">(Continued on next page)</p>	0 to 6E	24	Programming
H1-02	Terminal S4 Function Selection Terminal S4 Sel	<p>10: MOP Increase Closed = Speed Command Increases, Open = Speed Command Held. Must be set in conjunction with MOP Decrease and b1-02 must be set to 1.</p> <p>11: MOP Decrease Closed = Speed Command Decreases, Open = Speed Command Held. Must be set in conjunction with MOP Increase and b1-02 must be set to 1.</p> <p style="text-align: center;">(Continued on next page)</p>	0 to 6E	14	Programming

Table 1: Parameter List (Continued)

Parameter No.	Parameter Name Digital Operator Display	Description	Setting Range	Factory Setting	Menu Location
H1-03	Terminal S5 Function Selection Terminal S5 Sel	<p>12: Forward Jog Closed = Drive runs forward at speed command entered into parameter d1-17.</p> <p>13: Reverse Jog Closed = Drive runs in reverse at speed command entered into parameter d1-17.</p> <p>14: Fault Reset Closed = Resets the Drive after the fault and the run command have been removed.</p> <p>15: Fast-Stop N.O. Closed = Drive decelerates using C1-09, regardless of run command status.</p> <p>17: Fast-Stop N.C. Closed = Normal operation Open = Drive decelerates using C1-09, regardless of run command status.</p> <p>18: Timer Function Input for independent timer, controlled by b4-01 and b4-02. Used in conjunction with a multi-function digital output.</p> <p>19: PI Disable Turns off the PI controller, and PI setpoint becomes speed command.</p> <p>1B: Program Lockout Closed = All parameter settings can be changed. Open = Only speed command at U1-01 can be changed.</p> <p>1C: TrimCtl Increase Closed = Increase motor speed by value in d4-02. Open = Return to normal speed command. Not effective when using d1-01 thru d1-04 as a speed command. Must be used in conjunction with Trim Ctrl Decrease.</p> <p>1D: Trim Ctl Decrease Closed = Decrease motor speed by value in d4-02. Open = Return to normal speed command. Not effective when using d1-01 thru d1-04 as speed command. Must be used in conjunction with Trim Ctrl Increase.</p>	0 to 6E	3: 2-wire 0: 3-wire	Programming

Table 1: Parameter List (Continued)

Parameter No.	Parameter Name Digital Operator Display	Description	Setting Range	Factory Setting	Menu Location
Digital Inputs					
H1-04	Terminal S6 Function Selection Terminal S6 Sel	<p>1E: Ref Sample Hold Analog speed command is sampled then held at time of input closure.</p> <p>20: External fault, Normally Open, Always Detected, Ramp To Stop</p> <p>21: External fault, Normally Closed, Always Detected, Ramp To Stop</p> <p>22: External fault, Normally Open, During Run, Ramp To Stop</p> <p>23: External fault, Normally Closed, During Run, Ramp To Stop</p> <p>24: External fault, Normally Open, Always Detected, Coast To Stop</p> <p>25: External fault, Normally Closed, Always Detected, Coast To Stop</p> <p>26: External fault, Normally Open, During Run, Coast To Stop</p> <p>27: External fault, Normally Closed, During Run, Coast To Stop</p> <p>28: External fault, Normally Open, Always Detected, Fast-Stop</p> <p>29: External fault, Normally Open, Always Detected, Fast-Stop</p> <p>2A: External fault, Normally Open, During Run, Fast-Stop</p> <p>2B: External fault, Normally Closed, During Run, Fast-Stop</p> <p>2C: External fault, Normally Open, Always Detected, Alarm Only</p> <p>2D: External fault, Normally Closed, Always Detected, Alarm Only</p> <p>2E: External fault, Normally Open, During Run, Alarm Only</p> <p>2F: External fault, Normally Closed, During Run, Alarm Only</p> <p>34: PI SFS Cancel</p> <p>36: Option/Inv Sel 2 Selects source of speed command and sequence Closed = b1-01 & b1-02, Open = Option Card</p> <p>60: Motor Preheat Applies current to create heat to avoid condensation. Closed = Apply amount of current as set in parameter b2-09</p> <p>61: Speed Search 1 When closed as a run command is given, Drive does a speed search starting at maximum frequency (E1-04). (Current detection)</p>	0 to 6E	4: 2-wire 3: 3-wire	Programming
H1-05	Terminal S7 Function Selection Terminal S7 Sel	<p>62: Speed Search 2 When closed as a run command is given, Drive does a speed search starting at speed command. (Current detection).</p> <p>64: Speed Search 3</p> <p>67: Com Test Mode - Used to test RS-485/422 interface.</p> <p>68: High Slip Braking - Closed = Drive stops using High Slip Braking regardless of run command status.</p> <p>69: Jog2 - Closed = Drive runs at speed command entered into parameter d1-17. Direction determined by fwd/rev input. 3-wire control Only.</p> <p>6A: Drive Enable - Closed = Drive will accept run command. Open = Drive will not run. If running, Drive will stop per b1-03.</p> <p>6B: Com/Inv Sel - Selects source of speed command and sequence Closed = Serial Communication (R+,R-,S+,S-), Open = b1-01 & b1-02</p> <p>6C: Com/Inv Sel 2</p> <p>6D: Auto Mode Sel - Hand/Auto Selection - Closed = Auto, Open = Hand</p> <p>6E: Hand Mode Sel - Hand/Auto Selection - Closed = Hand, Open = Auto</p> <p>70: Bypass Drv Enbl</p>	0 to 6E	6: 2-wire 4: 3-wire	Programming

Table 1: E7 User Parameter List (Continued)

Parameter No.	Parameter Name Digital Operator Display	Description	Setting Range	Factory Setting	Menu Location
Digital Outputs					
H2-01	Terminal M1-M2 Function Selection Term M1-M2 Sel	<p>0: During RUN 1 = Closed when a run command is input or the Drive is outputting voltage.</p> <p>1: Zero Speed = Closed when Drive output frequency is less than Fmin (E1-09)</p> <p>2: Fref/Fout Agree 1 = Closed when Drive output speed equals the speed command within the bandwidth of L4-02.</p> <p>3: Fref/Set Agree 1 = Closed when the Drive output speed and the speed command are equal to the value in L4-01 within the bandwidth of L4-02.</p> <p>4: Freq Detect 1 = Closed when the Drive output speed is less than or equal to the value in L4-01, with hysteresis determined by L4-02.</p> <p>5: Freq Detect 2 = Closed when the Drive output speed is greater than or equal to the value in L4-01, with hysteresis determined by L4-02.</p> <p>6: Inverter Ready = Closed when the Drive is not in a fault state, and not in program mode.</p> <p>7: DC Bus Undervolt = Closed when the DC bus voltage falls below the UV trip level (L2-05)</p> <p>8: Base Blk 1 = Closed when the Drive is not outputting voltage.</p> <p>9: Option Reference = Closed when the speed command is coming from the digital operator.</p> <p>A: Remote/Auto Oper = Closed when the run command is coming from the digital operator.</p> <p>B: Trq Det 1 N.O. - Closes when the output current exceeds the value set in parameter L6-02 for more time than is set in parameter L6-03.</p> <p>C: Loss of Ref - Closes when the Drive has detected a loss of analog speed command. Speed command is considered lost when it drops 90% in 0.4 seconds. Parameter L4-05 determines Drive reaction to a loss of speed command.</p> <p>E: Fault - Closes when the Drive experiences a major fault.</p> <p>F: Not Used</p> <p>10: Minor Fault - Closes when Drive experiences a minor fault or alarm.</p> <p>11: Reset Cmd Active - Closes when the Drive receives a reset command from terminals or serial comms.</p> <p>12: Timer Output - Output for independent timer, controlled by b4-01 and b4-02. Used in conjunction with a multi-function digital input.</p> <p>17: Trq. Det 1 N.C. - Opens when the output current exceeds the value set in parameter L6-02 for more time than is set in parameter L6-03.</p> <p>1A: Reverse Dir - Closes when the Drive is running in the reverse direction.</p> <p>1E: Restart Enabled - Closes when the Drive is performing an automatic restart. Automatic restart is configured by parameter L5-01.</p> <p>1F: Overload (OL1) - Closes before a motor overload occurs. (90% of OL1 time)</p> <p>20: OH Prealarm - Closes when the Drive's heatsink temperature exceeds the setting of parameter L8-02.</p> <p>38: Drive Enable - Closes when the Drive enable input is active.</p> <p>39: Waiting to Run - Closes during the time after a run command is issued, but the Drive is not running due to the time set in parameter b1-10.</p> <p>3A: OH Freq Reduce</p> <p>3B: Run Src Com/Opt</p>	0 to 3B	0	Programming
H2-02	Terminal M3-M4 Function Selection Term M3-M4 Sel	<p>17: Trq. Det 1 N.C. - Opens when the output current exceeds the value set in parameter L6-02 for more time than is set in parameter L6-03.</p> <p>1A: Reverse Dir - Closes when the Drive is running in the reverse direction.</p> <p>1E: Restart Enabled - Closes when the Drive is performing an automatic restart. Automatic restart is configured by parameter L5-01.</p> <p>1F: Overload (OL1) - Closes before a motor overload occurs. (90% of OL1 time)</p> <p>20: OH Prealarm - Closes when the Drive's heatsink temperature exceeds the setting of parameter L8-02.</p> <p>38: Drive Enable - Closes when the Drive enable input is active.</p> <p>39: Waiting to Run - Closes during the time after a run command is issued, but the Drive is not running due to the time set in parameter b1-10.</p> <p>3A: OH Freq Reduce</p> <p>3B: Run Src Com/Opt</p>	0 to 3B	A	Programming

Table 1: Parameter List (Continued)

Parameter No.	Parameter Name Digital Operator Display	Description	Setting Range	Factory Setting	Menu Location
Analog Inputs					
H3-02 ◆	Terminal A1 Gain Setting Terminal A1 Gain	Sets the speed command when 10V is input, as a percentage of the maximum output frequency (E1-04).	0.0 to 1000.0	100.0%	Quick Setting
H3-03 ◆	Terminal A1 Bias Setting Terminal A1 Bias	Sets the speed command when 0V is input, as a percentage of the maximum output frequency (E1-04).	-100.0 to +100.0	0.0%	Quick Setting
H3-08	Terminal A2 Signal Level Selection Term A2 Signal	Selects the signal level of terminal A2. 0: 0 - 10VDC (switch S1-2 must be in the off position) 2: 4 - 20 mA (switch S1-2 must be in the on position)	0 or 2	2	Programming
H3-09	Aux Terminal Function Selection Terminal A2 Sel	Selects what effect the aux terminal has on the Drive. 0: Frequency Bias - 0 - 100% bias 2: Aux Reference B: PI Feedback D: Frequency Bias 2 - 0 - 100% bias E: Motor Temperature - See parameters L1-03 & L1-04 16: PI Differential 1F: Not Used	0 to 1F	2	Programming
H3-10 ◆	Terminal A2 Gain Setting Terminal A2 Gain	Sets the percentage when 10V (20mA) is input.	0.0 to 1000.0	100.0%	Quick Setting
H3-11 ◆	Terminal A2 Bias Setting Terminal A2 Bias	Sets the percentage when 0V (4mA) is input.	-100.0 to +100.0	0.0%	Quick Setting
H3-12	Analog Input Filter Time Constant Filter Avg Time	Used to "smooth" out erratic or noisy analog input signals.	0.00 to 2.00	0.30sec	Programming
H3-13	Master Frequency Reference Terminal Selection TA1/A2 Select	Determines which terminal will be the main reference source. 0: Main Fref TA1 - Terminal TA1 is the main speed command and Terminal TA2 is the Aux speed command. 1: Main Fref TA2 - Terminal TA2 is the main speed command and Terminal TA1 is the Aux speed command. Only effective when H3-09 is set to 2 "Aux Reference".	0 or 1	0	Programming
◆Denotes that parameter can be changed when the Drive is running.					

Table 1: Parameter List (Continued)

Parameter No.	Parameter Name Digital Operator Display	Description	Setting Range	Factory Setting	Menu Location
Analog Outputs					
H4-01	Terminal FM Monitor Selection Terminal FM Sel	Selects which monitor will be output on terminals FM and AC. 1: Frequency Ref (100% = max. output frequency) 2: Output Freq (100% = max. output frequency) 3: Output Current (100% = Drive rated current) 6: Output Voltage (100% = 230V or 100% = 460V) 7: DC Bus Voltage (100% = 400V or 100% = 800V) 8: Output kWatts (100% = Drive rated power) 15: Term A1 Level 16: Term A2 Level 18: Mot SEC Current (100% = Motor rated secondary current) 20: SFS Output (100% = max. output frequency) 24: PI Feedback 31: Not Used 36: PI Input 37: PI Output (100% = max. output frequency) 38: PI Setpoint 51: Auto Mode Fref (100% = max. output frequency) 52: Hand Mode Fref (100% = max. output frequency) 53: PI Feedback 2 NOTE: 100% = 10V DC output * FM gain setting (H4-02).	1 to 53	2	Programming
H4-02 ◆	Terminal FM Gain Setting Terminal FM Gain	Sets terminal FM output voltage (in percent of 10V) when selected monitor is at 100% output.	0.0 to 1000.0	100.0%	Programming
H4-03 ◆	Terminal FM Bias Setting Terminal FM Bias	Sets terminal FM output voltage (in percent of 10V) when selected monitor is at 0% output.	-110.0 to 110.0	0.0%	Programming
H4-04	Terminal AM Monitor Selection Terminal AM Sel	Selects which monitor will be output on terminals AM and AC. 1: Frequency Ref (100% = max. output frequency) 2: Output Freq (100% = max. output frequency) 3: Output Current (100% = Drive rated current) 6: Output Voltage (100% = 230V or 100% = 460V) 7: DC Bus Voltage (100% = 400V or 100% = 800V) 8: Output kWatts (100% = Drive rated power) 15: Term A1 Level 16: Term A2 Level 18: Mot SEC Current (100% = Motor rated secondary current) 20: SFS Output (100% = max. output frequency) 24: PI Feedback 31: Not Used 36: PI Input 37: PI Output (100% = max. output frequency) 38: PI Setpoint 51: Auto Mode Fref (100% = max. output frequency) 52: Hand Mode Fref (100% = max. output frequency) 53: PI Feedback 2 NOTE: 100% = 10V DC output * AM gain setting (H4-05).	1 to 53	8	Programming
H4-05 ◆	Terminal AM Gain Setting Terminal AM Gain	Sets terminal AM output voltage (in percent of 10V) when selected monitor is at 100% output.	0.0 to 1000.0	50.0%	Programming
◆Denotes that parameter can be changed when the Drive is running.					

Table 1: Parameter List (Continued)

Parameter No.	Parameter Name Digital Operator Display	Description	Setting Range	Factory Setting	Menu Location
Analog Outputs					
H4-06 ◆	Terminal AM Bias Setting Terminal AM Bias	Sets terminal AM output voltage (in percent of 10V) when selected monitor is at 0% output.	-110.0 to 110.0	0.0%	Programming
H4-07	Terminal FM Signal Level Selection AO Level Select1	0: 0 - 10 VDC 2: 4-20 mA*	0 or 2	0	Programming
H4-08	Terminal AM Signal Level Selection AO Level Select2	0: 0 - 10 VDC 2: 4-20 mA* * An analog output of 4 - 20 mA can not be used with the standard terminal board. Therefore an optional terminal board (with shunt connector CN15) is needed.	0 or 2	0	Programming
Serial Com Setup					
H5-01	Drive Node Address Serial Com Adr	Selects Drive station node number (address) for terminals R+, R-, S+, S-.* Note: An address of "0" disables serial com.	0 to FF(hex, H5-08 dependent)	1F	Programming
H5-02	Communication Speed Selection Serial Baud Rate	Selects the baud rate for terminals R+, R-, S+ and S-.* 0: 1200 Baud 1: 2400 Baud 2: 4800 Baud 3: 9600 Baud 4: 19200 Baud	0 to 4	3	Programming
H5-03	Communication Parity Selection Serial Com Sel	Selects the communication parity for terminals R+, R-, S+ and S-.* 0: No Parity 1: Even Parity 2: Odd Parity	0 to 2	0	Programming
H5-04	Stopping Method after Communication Error Serial Fault Sel	Selects the stopping method when a communication error is detected. 0: Ramp to Stop 1: Coast to Stop 2: Fast-Stop 3: Alarm Only 4: Runn at D1-04	0 to 3	3	Programming
H5-05	Communication Error Detection Selection Serial Flt Dtct	Enables or disables the communications timeout detection function. 0: Disabled - A communications loss will NOT cause a communications fault. 1: Enabled - If communications are lost for more than the time specified in parameter H5-09, a communications fault will occur.	0 or 1	1	Programming
H5-06	Drive Transmit Wait Time Transmit WaitTIM	Sets the time from when the Drive receives data to when the Drive sends data.	5 to 65	5ms	Programming
H5-07	RTS Control Selection RTS Control Sel	Enables or disables "request to send" (RTS) control: 0: Disabled (RTS is always on) 1: Enabled (RTS turns on only when sending)	0 or 1	1	Programming
H5-08	Communication Protocol Selection Protocol Select	Selects the communication protocol. 0: Memobus (Modbus)	0	0	Programming
H5-09	Communication Error Detection Time CE Detect Time	Determines how long communications must be lost before a fault is annunciated. Works in conjunction with parameters H5-05 and H5-04.	0.0 to 10.0	2.0sec	Programming
◆Denotes that parameter can be changed when the Drive is running. * After these parameters are changed, Drive power must be cycled before the changes will take effect.					

Table 1: Parameter List (Continued)

Parameter No.	Parameter Name Digital Operator Display	Description	Setting Range	Factory Setting	Menu Location
		Motor Overload			
L1-01	Motor Overload Protection Selection MOL Fault Select	Enables or disables the motor thermal overload protection. 0: Disabled 1: Std Fan Cooled (Enabled)	0 to 1	1	Programming
L1-02	Motor Overload Protection Time MOL Time Const	Determines how much time will elapse prior to a motor overload fault (OL1), when motor amps exceed the value set in parameter E2-01 by 10%. Actual (OL1) trip time will vary depending on severity of overload.	0.1 to 20.0	8.0min	Programming
L1-03	Motor Overheat Alarm Operation Selection Mtr OH Alarm Sel	Operation selection when the motor temperature analog input (H3-09=E) exceeds the OH3 alarm level (1.17V) 0: Ramp to Stop 1: Coast to Stop 2: Fast-Stop 3: Alarm Only	0 to 3	3	Programming
L1-04	Motor Overheat Fault Operation Selection Mtr OH Fault Sel	Stopping method when the motor temperature analog input (H3-09=E) exceeds the OH4 level (2.34V). 0: Ramp to Stop 1: Coast to Stop 2: Fast-Stop	0 to 2	1	Programming
L1-05	Motor Temperature Input Filter Time Mtr Temp Filter	Delay Time applied to motor temperature analog input (H3-09=E) for filtering purposes.	0.00 to 10.00	0.20sec	Programming
		PwrLoss Ridethru			
L2-01	Momentary Power Loss Detection Selection PwrL Selection	Enables and disables the momentary power loss function. 0: Disabled - Drive trips on (UV1) fault when power is lost. 1: PwrL Ride Thru t - Drive will restart if power returns within the time set in L2-02.* 2: CPU Power Active - Drive will restart if power returns prior to internal power supply shut down.* * In order for a restart to occur, the run command must be maintained throughout the ride thru period.	0 to 2	2	Quick Setting
L2-02	Momentary Power Loss Ride-thru Time PwrL Ridethru t	Determines the power loss ride-thru time. This value is dependent on the capacity of the Drive. Only effective when L2-01 = 1.	0.0 to 25.5sec	kVA Dependent	Quick Setting
L2-03	Momentary Power Loss Minimum Base Block Time PwrL Baseblock t	Used to allow the residual motor voltage to decay before the Drive output turns back on. After a power loss, if L2-03 is greater than L2-02, operation resumes after the time set in L2-03.	0.1 to 5.0sec	kVA Dependent	Programming
L2-04	Momentary Power Loss Voltage Recovery Ramp Time PwrL V/F Ramp t	The time it takes the output voltage to return to the preset V/f pattern after speed search (current detection mode) is complete.	0.0 to 5.0sec	kVA Dependent	Programming
L2-05	Undervoltage Detection Level PUV Det Level	Sets the Drive's DC Bus undervoltage trip level. If this is set lower than the factory setting, additional AC input reactance or DC bus reactance may be necessary.	Voltage Class Dependent	Voltage Class Dependent	Programming

Table 1: Parameter List (Continued)

Parameter No.	Parameter Name Digital Operator Display	Description	Setting Range	Factory Setting	Menu Location
Stall Prevention					
L3-01	Stall Prevention Selection During Accel StallP Accel Sel	<p>0: Disabled (Motor accelerates at active acceleration, C1-01 or C1-03. The motor may stall if load is too heavy or accel time is too short.)</p> <p>1: General Purpose (When output current exceeds L3-02 level, acceleration stops. It starts to accelerate at current value recovery.)</p> <p>2: Intelligent (The active acceleration rate, C1-01 or C1-02, is ignored. Acceleration is completed in the shortest amount of time w/o exceeding the current value set in L3-02.)</p>	0 to 2	1	Programming
L3-02	Stall Prevention Level During Accel StallP Accel Lvl	This function is enabled when L3-01 is "1" or "2". Drive rated current is 100%. Decrease the set value if stalling occurs at factory setting.	0 to 200	120%	Programming
L3-04	Stall Prevention Selection During Decel StallP Decel Sel	<p>0: Disabled (The Drive decelerates at the active deceleration rate, C1-02 or C1-04. If the load is too large or the deceleration time is too short, an OV fault may occur.)</p> <p>1: General Purpose (The Drive decelerates at the active deceleration rate, C1-02 or C1-04, but if the main circuit DC bus voltage reaches the stall prevention level the output frequency will clamp. Deceleration will continue once the DC bus level drops below the stall prevention level.)</p> <p>2: Intelligent (The active deceleration rate is ignored and the Drive decelerates as fast as possible w/o hitting OV fault level.)</p> <p>3: Stall prev w/R (When using a dynamic braking resistor, be sure to set L3-04 to either "0" or "3". Setting "3" will yield a quicker deceleration rate than "0".)</p>	0 to 3	1	Programming
L3-05	Stall Prevention Level During Decel StallP Run Sel	<p>0: Disabled (Drive runs a set frequency.) A heavy load may cause the Drive to trip on an OC fault.</p> <p>1: Decel Time 1 (In order to avoid stalling during heavy loading, the Drive will start to decelerate at Decel time 1 (C1-02) if the output current exceeds the level set by L3-06. Once the current level drops below the L3-06 level the Drive will accelerate back to its set frequency at the active acceleration rate.)</p> <p>2: Decel Time 2 (Same as setting 1 except the Drive decelerates at Decel Time 2 (C1-04).) For 6Hz or less frequency, stall prevention function during run is disabled regardless of L3-05 set.</p>	0 to 2	1	Programming
L3-06	Stall Prevention Level During Running StallP Run Level	This function is enabled when L3-05 is "1" or "2". Drive rated current is set as 100%. Normally, changing the setting is not required. Decrease the set value if stalling occurs at factory setting.	30 to 200	120%	Programming

Table 1: Parameter List (Continued)

Parameter No.	Parameter Name Digital Operator Display	Description	Setting Range	Factory Setting	Menu Location
		Ref Detection			
L4-01	Speed Agreement Detection Level Spd Agree Level	L4-01 and L4-02 are used in conjunction with the multi-function outputs, (H2-01 and H2-02) as a setpoint and hysteresis for a contact closure.	0.0 to 200.0	0.0Hz	Programming
L4-02	Speed Agreement Detection Width Spd Agree Width		0.0 to 20.0	2.0Hz	Programming
L4-05	Frequency Reference Loss Detection Selection Ref Loss Sel	Determines how the Drive will react when the frequency reference is lost. 0: Disabled - Drive will not run at the frequency reference 1: Enabled @ % of PrevRef - Drive will run at a percentage (L4-06) of the frequency reference level at the time frequency reference was lost.	0 or 1	1	Quick Setting
L4-06	Frequency Reference Level at Loss Frequency Fref at Floss	If Frequency Reference loss function is enabled (L4-05=1) and Frequency Reference is lost, then the Drive will run at reduced frequency reference determined by L4-06. New Fref=Fref at time of loss L4-06.	0 to 100.0%	80.0%	Quick Setting
		Fault Restart			
L5-01	Number of Auto Restart Attempts Num of Restarts	Determines the number of times the Drive will perform an automatic restart.	0 to 10	0	Quick Setting
L5-02	Auto Restart Operation Selection Restart Sel	Determines if the fault contact activates during an automatic restart attempt. 0: No Flt Relay - fault contact will not activate during an automatic restart. 1: Flt Relay Active - fault contact will activate during an automatic restart.	0 or 1	0	Programming
L5-03	Maximum Restart Time After Fault Max Restart Time	If the restart fails (or is not attempted due to a continuing fault condition, e.g. an OV fault) the Drive waits L5-03 seconds before attempting another restart.	0.5 to 600.0	180.0sec	Quick Setting
		Torque Detection			
L6-01	Torque Detection Selection 1 Torq Det 1 Sel	Determines the Drive's response to an overtorque / undertorque condition. Overtorque and Undertorque are determined by the settings in parameters L6-02 and L6-03. 0: Disabled 1: OL@SpdAgree - Alm (Overtorque Detection only active during Speed Agree and Operation continues after detection) 2: OL At RUN - Alm (Overtorque Detection is always active and operation continues after detection) 3: OL@SpdAgree - Flt (Overtorque Detection only active during Speed Agree and Drive output will shut down on an OL3 fault.) 4: OL At RUN - Flt (Overtorque Detection is always active and Drive output will shut down on an OL3 fault.) 5: UL@SpdAgree - Alm (Undertorque Detection is only active during Speed Agree and operation continues after detection.) 6: UL at RUN - Alm (Undertorque Detection is always active and operation continues after detection.) 7: UL @ SpdAgree - Flt (Undertorque Detection only active during Speed Agree and Drive output will shut down on an OL3 fault.) 8: UL At RUN - Flt (Undertorque Detection is always active and Drive output will shut down on an OL3 fault.)	0 to 8	0	Quick Setting
L6-02	Torque Detection Level 1 Torq Det 1 Lvl	Sets the overtorque/undertorque detection level as a percentage of Drive rated current.	0 to 300	15%	Quick Setting
L6-03	Torque Detection Time 1 Torq Det 1 Time	Sets the length of time an overtorque / undertorque condition must exist before being recognized by the Drive. OL3 is then displayed.	0.0 to 10.0	10.0sec	Quick Setting

Table 1: Parameter List (Continued)

Parameter No.	Parameter Name Digital Operator Display	Description	Setting Range	Factory Setting	Menu Location
Hdwe Protection					
L8-01	Internal Dynamic Braking Resistor Protection Selection DB Resistor Prot	0: Not Provided 1: Provided	0 or 1	0	Programming
L8-02	Overheat Pre-Alarm Level OH Pre-Alarm Lvl	When the cooling fin temperature exceeds the value set in this parameter, an overheat pre-alarm (OH) will occur.	50 to 130	95°C	Programming
L8-03	Overheat Pre-Alarm Operation Selection OH Pre-Alarm Sel	Drive Operation upon OH Pre Alarm Detection. 0: Ramp to Stop (Decel Time C1-02). 1: Coast to Stop 2: Fast-Stop (Decel Time = C1-09). 3: Alarm Only *0 to 2 is recognized as fault detection, and 3 is recognized as alarm. (For the fault detection, the fault contact operates.) 4: OH Alarm & Reduce (Continue operation and reduce output frequency by L8-19)	0 to 4	4	Programming
L8-06	Input Phase Loss Detection Level Ph Loss In Lvl	Monitors the DC Bus current ripple and activates when one of the input phases is lost (PF).	0.0 to 25.0	5.0%	Programming
L8-09	Output Ground Fault Detection Selection Ground Fault Sel	Enables and disables Drive output ground fault detection. 0: Disabled 1: Enabled	0 or 1	1	Programming
L8-10	Heatsink Cooling Fan Operation Selection Fan On/Off Sel	Controls the Heatsink Cooling Fan Operation. 0: Fan On-Run Mode (Fan will operate only when Drive is running and for L8-11 seconds after RUN is removed). 1: Fan Always On (Cooling fan operates whenever Drive is powered up.)	0 or 1	0	Programming
L8-11	Heatsink Cooling Fan Operation Delay Time Fan Delay Time	When L8-10=0 this parameter sets a delay time for Cooling Fan de-energization after the run command is removed.	0 to 300	300sec	Quick Setting
L8-12	Ambient Temperature Setting Ambient Temp	When the Drive is installed in an ambient temperature exceeding its rating, Drive overload (OL2) protection level is reduced.	45 to 60°C	45°C	Programming
L8-15	OL2 Characteristic Selection at Low Speeds OL2 Sel @ L-Spd	This parameter assists in protecting the output transistor junctions from overheating when output current is high and output frequency is low. 0: Disabled 1: Enabled (L8-18 is active)	0 or 1	1	Programming
L8-18	Soft CLA Selection Soft CLA Sel	Enables and disables current limit "A" 0: Disabled 1: Enabled.	0 or 1	1	Programming
L8-19	OH Frequency Reference Reduction Level Fref During OH	Sets the amount of frequency reference reduction when an Overheat Pre-alarm (OH) is detected.	0.0 to 100.0	20.0%	Programming

Table 1: Parameter List (Continued)

Parameter No.	Parameter Name Digital Operator Display	Description	Setting Range	Factory Setting	Menu Location
Hunting Prev					
n1-01	Hunting Prevention Selection Hunt Prev Select	0: Disabled (Hunting prevention function disabled.) 1: Enabled (Hunting prevention function enabled.) If the motor vibrates while lightly loaded, hunting prevention may reduce the vibration. There is a loss of responsiveness if hunting prevention is enabled.	0 or 1	1	Programming
n1-02	Hunting Prevention Gain Setting Hunt Prev Gain	Gain setting for the Hunting Prevention Function. If the motor vibrates while lightly loaded and n1-01=1, increase the gain by 0.1 until vibration ceases. If the motor stalls while n1-01=1 decrease the gain by 0.1 until the stalling ceases.	0.00 to 2.50	1.00	Programming
HighSlip					
n3-01	High-Slip Braking Deceleration Frequency Width HSB Decel Width	Sets how aggressively the Drive decreases the output frequency as it stops the motor. If overvoltage (OV) faults occur during HSB, this parameter may need to be increased.	1 to 20	5%	Programming
n3-02	High-Slip Braking Current Limit HSB Current Ref	Sets the maximum current to be drawn during a HSB stop. Higher n3-02 settings will shorten motor stopping times but cause increased motor current, and therefore increased motor heating.	100 to 200	150%	Programming
n3-03	High-Slip Braking Dwell Time at Stop HSB DwellTim@ Stp	Sets the amount of time the Drive will dwell at E1-09 (Minimum Frequency). If this time is set too low, the machine inertia can cause the motor to rotate slightly after the HSB stop is complete and the Drive output is shut off.	0.0 to 10.0	1.0sec	Programming
n3-04	High-Slip Braking Overload Time HSB OL Time	Sets the time required for a HSB Overload Fault to occur when the Drive output frequency does not change for some reason during a HSB stop. Normally this does not need to be adjusted.	30 to 1200	40sec	Programming
Monitor Select					
o1-01 ◆	User Monitor Selection User Monitor Sel	Selects which monitor will be displayed upon power-up when o1-02 = 4.	6 to 53	6	Quick Setting
o1-02	User Monitor Selection After Power-Up Power-On Monitor	Selects which monitor will be displayed upon power-up. 1: Frequency Ref 2: Output Freq 3: Output Current 4: User Monitor (set by o1-01)	1 to 4	1	Programming
o1-03	Digital Operator Display Selection Display Scaling	Sets the units of the Frequency References (d1-01 through d1-17) and the Frequency Reference Monitor (U1-01). 0: Hz 1: % (100% = E1-04) 2 to 39: RPM. (Enter the number of motorpoles.) 40 to 39999: User display Desired set/display value is set at Max.  output frequency. 4 digit number. The number of digits from the right the decimal point is displayed. Example: If “200.0 is displayed at Max. output frequency, set “12000”.	0 to 39999	0	Programming

Table 1: Parameter List (Continued)

Parameter No.	Parameter Name Digital Operator Display	Description	Setting Range	Factory Setting	Menu Location								
o1-05	LCD Brightness Adjustment LCD Contrast	<table border="1"> <thead> <tr> <th>Set Value</th> <th>Description</th> </tr> </thead> <tbody> <tr> <td>5</td> <td>LCD display becomes dark.</td> </tr> <tr> <td>3</td> <td>Standard setting</td> </tr> <tr> <td>1</td> <td>LCD display becomes light.</td> </tr> </tbody> </table>	Set Value	Description	5	LCD display becomes dark.	3	Standard setting	1	LCD display becomes light.	0 to 5	3	Quick Setting
		Set Value	Description										
		5	LCD display becomes dark.										
		3	Standard setting										
1	LCD display becomes light.												
o1-06	User Monitor Selection Mode Monitor Mode Sel	Selects the "U1" monitors displayed on the 4th and 5th lines of the digital operator display. 0: 3 Mon Sequential (Displays the next 2 sequential U1 monitors.) 1: 3 Mon Selectable (Displays U1 monitors set by o1-07 and o1-08.)	0 or 1	0	Programming								
o1-07	Second Line User Monitor Selection 2nd Monitor Sel	Sets the "U1" monitor always displayed on the 4th line of the digital operator display. Effective only when o1-06 = 1.	1 to 53	2	Quick Setting								
o1-08	Third Line User Monitor Selection 3rd Monitor Sel	Sets the "U1" monitor always displayed on the 5th line of the digital operator display. Effective only when o1-06 = 1.	1 to 53	3	Quick Setting								
Key Selections													
o2-01	Local/Remote Key Function Selection Local/Remote Key	Has no function when HOA operator (Part# JVOP-162) is connected.											
o2-02	OFF Key Function During Auto Run Oper STOP Key	Determines if the off key on the digital operator will stop the Drive when Drive is operating from external terminals or serial communications. 0: Disabled 1: Enabled	0 or 1	1	Programming								
o2-03	User Parameter Default Value User Defaults	Allows storing of current parameter values as a User Initialization Selection at parameter A1-03. 0: No Change (No user parameter set active). 1: Set Defaults (Saves current parameter settings as user initialization. A1-03 now allows selecting <1110> for user initialization. 2: Clear All (Clears the currently saved user initialization. A1-03 no longer allows selecting <1110>.	0 to 2	0	Quick Setting								
o2-04	Drive/kVA Selection Inverter Model #	Sets the kVA of the Drive. Enter the number based on Drive Model #. Use the □□□□ portion of the CIMR-E7□□□□ Model Number. Reference Appendix 2	0 to FF	kVA Dependent	Programming								
o2-05	Frequency Reference Setting Method Selection Operator M.O.P.	Determines if the Data/Enter key must be used to input a frequency reference from the digital operator. 0: Disabled - Data/Enter key must be pressed to enter a frequency reference. 1: Enabled - Data/Enter key is not required. The frequency reference is adjusted by the up and down arrow keys on the digital operator without having to press the data/enter key.	0 or 1	1	Quick Setting								
o2-06	Operation Selection when Digital Operator is Disconnected Oper Detection	Determines if the Drive will stop when the digital operator is removed. 0: Disabled - The Drive will not stop when the digital operator is removed. 1: Enabled - The Drive will fault (OPR) and coast to stop when the operator is removed.	0 or 1	1	Programming								
o2-07	Cumulative Operation Time Setting Elapsed Time Set	Sets the initial value of the elapsed operation timer.	0 to 65535	0H	Programming								
◆Denotes that parameter can be changed when the Drive is running.													

Table 1: Parameter List (Continued)

Parameter No.	Parameter Name Digital Operator Display	Description	Setting Range	Factory Setting	Menu Location
o2-08	Cumulative Operation Time Selection Elapsed Time Run	Sets how time is accumulated for the elapsed timer (o2-07). 0: Power-On Time (Time accumulates whenever Drive is powered). 1: Running Time (Time accumulates only when Drive is running)	0 or 1	1	Quick Setting
o2-09	Initialization Specification Selection Init Mode Sel	Determines parameter values after a Drive initialization (A1-03) is executed. This should always be set to "1" American Spec. 1: American spec 2: European spec 4: PV-A spec 5: PV-E spec	1 to 5	1	Programming
o2-10	Cumulative Cooling Fan Operation Time Setting Fan ON Time Set	Sets the initial value of the heatsink fan operation time.	0 to 65535	0H	Programming
o2-12	Fault Trace/Fault History Clear Function FLT Trace Init	Clears the fault memory contained in the U2 and U3 monitors. 0: Disabled (no effect). 1: Enabled - resets U2 and U3 monitors, and returns o2-12 to zero.	0 or 1	0	Programming
o2-14	kWh User Monitor (U1-29) Initialization kWH MonitorClear	Used to reset the kilowatt Hour monitor to zero 0: Disabled (no change). 1: Clear all - Resets U1-29 to zero and returns o2-14 to zero.	0 or 1	0	Programming
o2-15	Hand Key Function Selection Oper Hand Key	Enables or disables the "Hand" key on the digital operator. 0: Disabled 1: Enabled	0 or 1	1	Programming
COPY Function					
o3-01	Copy Function Selection Copy Function Sel	This parameter controls the copying of parameters to and from the digital operator. 0: COPY SELECT (no function) 1: INV -> OP READ - All parameters are copied from the Drive to the digital operator. 2: OP -> INV WRITE - All parameters are copied from the digital operator into the Drive. 3: OP<->INV VERIFY - Parameter settings in the Drive are compared to those in the digital operator. NOTE: When using the copy function, the Drive model number and software number (U1-14) must match or an error will occur.	0 to 3	0	Programming
o3-02	Read Allowed Selection Read Allowable	Enables and disables all digital operator copy functions. 0: Disabled - No digital operator copy functions are allowed. 1: Enabled - Copying allowed	0 to 1	0	Quick Setting
Auto-Tuning					
T1-02	Motor Rated Power Mtr Rated Power	Sets the motor rated power in kW. NOTE: If motor power is given in horsepower, power in kW can be calculated using the following formula: $kW = Hp * 0.746$	0.00 to 650.00	kVA Dependent	Auto-Tuning
T1-04	Motor Rated Current Rated Current	Sets the motor rated current. (Used only during an auto-tune).	kVA Dependent	kVA Dependent	Auto-Tuning

Monitor List

Table 2: Monitor List

Parameter No.	Parameter Name Digital Operator Display	Description
Monitor		
U1-01	Frequency Reference Frequency Ref	Frequency reference (speed command) monitor when in auto mode, frequency reference (speed command) setting location when in hand mode. Units changeable via o1-03.
U1-02	Output Frequency Output Freq	Output frequency (speed) monitor. Units changeable via o1-03.
U1-03	Output Current Output Current	Output current monitor
U1-06	Output Voltage Output Voltage	Displays Drive output voltage
U1-07	DC Bus Voltage DC Bus Voltage	Displays DC Bus Voltage
U1-08	Output Power Output kWatts	Displays Drive output power
U1-10	Input Terminal Status Input Term Sts	<p>Displays Drive input terminal status</p>
U1-11	Output Terminal Status Output Term Sts	<p>Output terminal ON/OFF Check</p>
U1-12	Drive Operation Status Int Ctl Sts 1	

Table 2: Monitor List (Continued)

Parameter No.	Parameter Name Digital Operator Display	Description
Monitor		
U1-13	Cumulative Operation Time Elapsed Time	Displays total operating or power-on time of the Drive.
U1-14	Software Number FLASH ID	Displays Drive's software number.
U1-15	Terminal A1 Input Voltage Term A1 Level	Displays the input voltage on Terminal A1, as a percentage of 10V DC.
U1-16	Terminal A2 Input Voltage Term A2 level	Displays the input current (or voltage) on Terminal A2, as a percentage of 20mA (or 10 V DC).
U1-18	Motor Secondary Current (I _q) Mot SEC Current	Displays the amount of current being used by the motor to produce torque (I _q).
U1-20	Output Frequency After Soft Start SFS Output	Displays the frequency reference (speed command) after the accel and decel ramps.
U1-24	PI Feedback Value PI Feedback	Displays the feedback signal when PI control is used.
U1-28	CPU Number CPU ID	Displays control board hardware revision.
U1-29	kWh kWh Lo 4 Digits	Displays the accumulated kWh.
U1-30	MWh kWh Hi 5 Digits	Displays the accumulated MWh.
U1-34	First Parameter Causing an OPE OPE Detected	Displays the parameter number causing an "OPE" fault.
U1-36	PI Input PI Input	Displays the "error" in the PI regulator. (U1-36 = PI Setpoint - PI Feedback).
U1-37	PI Output PI Output	Displays the output of the PI as a percentage of maximum frequency (E1-04).
U1-38	PI Setpoint PI Setpoint	Displays the setpoint of the PI regulator (U1-38 = PI reference + PI bias).
U1-39	Memobus Communication Error Code Transmit Err	
U1-40	Heatsink Cooling Fan Operation Time FAN Elapsed Time	Displays total operating time of the heatsink cooling fan.
U1-51	Auto Mode Frequency Reference Value Auto Mode Fref	Displays the frequency reference (speed command) when in auto mode.
U1-52	Hand Mode Frequency Reference Value HAND Mode Fref	Displays the frequency reference (speed command) when in hand mode, or displays Terminal A2 when differential mode is selected.
U1-53	PI Feedback 2 Value PI Feedback 2	Displays PI feedback 2 value.

Fault Trace List

Table 3: Fault Trace List

Fault Trace	
U2-01	Current Fault Current Fault
U2-02	Previous Fault Last Fault
U2-03	Frequency Reference at Most Recent Fault Frequency Ref
U2-04	Output Frequency at Most Recent Fault Output Freq
U2-05	Output Current at Most Recent Fault Output Current
U2-07	Output Voltage at Most Recent Fault Output Voltage
U2-08	DC Bus Voltage at Most Recent Fault DC Bus Voltage
U2-09	Output Power at Most Recent Fault Output kWatts
U2-11	Input Terminal Status at Most Recent Fault. The format is the same as for U1-10. Input Term Sts
U2-12	Output Terminal Status at Most Recent Fault. The format is the same as for U1-11. Output Term Sts
U2-13	Drive Operation Status at Most Recent Fault. The format is the same as for U1-12. Inverter Status
U2-14	Cumulative Operation Time at Most Recent Fault Elapsed time
(Note) Fault trace is not executed at CPF00, CPF01, CPF03, UVI and UV2.	

Fault History List

Table 4: Fault History List

Fault Trace	
U3-01	Most Recent Fault Last Fault
U3-02	2 nd Most Recent Fault Fault Message 2
U3-03	3 rd Most Recent Fault Fault Message 3
U3-04	4 th Most Recent Fault Fault Message 4
U3-05	Cumulative Operation Time at Most Recent Fault Elapsed Time 1
U3-06	Cumulative Operation Time at 2 nd Most Recent Fault Elapsed Time 2
U3-07	Cumulative Operation Time at 3 rd Most Recent Fault Elapsed Time 3
U3-08	Cumulative Operation Time at 4 th Most Recent Fault Elapsed Time 4
U3-09	5 th Most Recent Fault Fault Message 5
U3-10	6 th Most Recent Fault Fault Message 6
U3-11	7 th Most Recent Fault Fault Message 7
U3-12	8 th Most Recent Fault Fault Message 8
U3-13	9 th Most Recent Fault Fault Message 9
U3-14	10 th Most Recent Fault Fault Message 10
U3-15	Cumulative Operation Time at 5 th Most Recent Fault Elapsed Time 5
U3-16	Cumulative Operation Time at 6 th Most Recent Fault Elapsed Time 6
U3-17	Cumulative Operation Time at 7 th Most Recent Fault Elapsed Time 7
U3-18	Cumulative Operation Time at 8 th Most Recent Fault Elapsed Time 8
U3-19	Cumulative Operation Time at 9 th Most Recent Fault Elapsed Time 9
U3-20	Cumulative Operation Time at 10 th Most Recent Fault Elapsed Time 10
(Note) Faults such as CPF00, CPF01, CPF02, CPF03, UV1, and UV02 are not stored in fault history.	

Notes:

Appendix B

Capacity Related Parameters

This appendix lists the parameters affected by the Drive Capacity setting of o2-04.

Drive Capacity	2
Parameters Affected by o2-04	3

Drive Capacity

Parameter o2-04 sets the Drive capacity according to the model number. Parameter o2-04 will need to be adjusted when replacing a control board.

If a Control PCB is changed, the first time the Drive is powered up, parameter o2-04 must be set to the appropriate value listed in *Table B.1* for the Drive model number. After properly setting parameter 02-04, a 2-wire or 3-wire initialization must be performed by setting parameter A1-03=2220 or A1-03=3330, respectively. This will automatically program the values of all other parameters listed in *Table B.2* to the factory settings for that particular Drive rating.

Table B.1 Drive Capacity Selection			
Voltage	Model Number	o2-04 Setting	Nominal Hp
208-240VAC	CIMR-P7U20P4	0	0.5/0.75
	CIMR-P7U20P7	1	1
	CIMR-P7U21P5	2	1.5/2
	CIMR-P7U22P2	3	3
	CIMR-P7U23P7	4	5
	CIMR-P7U25P5	5	7.5
	CIMR-P7U27P5	6	10
	CIMR-P7U2011	7	15
	CIMR-P7U2015	8	20
	CIMR-P7U2018	9	25
	CIMR-P7U2022	A	30
	CIMR-P7U2030	B	40
208-230VAC	CIMR-P7U2037	C	50
	CIMR-P7U2045	D	60
	CIMR-P7U2055	E	75
	CIMR-P7U2075	F	75/100
	CIMR-P7U2090	10	125
	CIMR-P7U2110	11	150
480VAC	CIMR-P7U40P4	20	0.5/0.75
	CIMR-P7U40P7	21	1
	CIMR-P7U41P5	22	1.5/2
	CIMR-P7U42P2	23	3
	CIMR-P7U43P7	24	5
	CIMR-P7U45P5	26	7.5
	CIMR-P7U47P5	27	10
	CIMR-P7U4011	28	15/20
	CIMR-P7U4015	29	25
	CIMR-P7U4018	2A	30
	CIMR-P7U4030	2C	40/50
	CIMR-P7U4037	2D	60
	CIMR-P7U4045	2E	75
	CIMR-P7U4055	2F	100
	CIMR-P7U4075	30	125
	CIMR-P7U4090	31	150
	CIMR-P7U4110	32	200
	CIMR-P7U4160	34	250
	CIMR-P7U4185	35	300/350
	CIMR-P7U4220	36	400/450
CIMR-P7U4300	37	500+	

◆ Parameters Affected by o2-04

The factory setting of the following parameters may change when the Drive capacity is changed.

Table B.2 Parameters Affected by o2-04	
Parameter Number	Parameter Name Digital Operator Display
b8-04	Energy Saving Coefficient Value Energy Save COEF
C6-02	Carrier Frequency Selection CarrierFreq Sel
E2-01	Motor Rated Current Motor Rated FLA
E2-03	Motor No Load Current No-Load Current
E2-05	Motor Line-to-Line Resistance Term Resistance
L2-02	Momentary Power Loss Ride-thru Time PwrL Ridethru t
L2-03	Momentary Power Loss Minimum Base Block Time PwrL Baseblock t
L2-04	Momentary Power Loss Voltage Recovery Ramp Time PwrL V/F Ramp t
L8-02	Overheat Pre-Alarm Level OH Pre-Alarm Lvl
L8-06	Input Phase Loss Detection Level Ph Loss In Lvl
o2-04	Drive/kVA Selection Inverter Model #

The following tables detail the factory default settings for the parameters that are affected by the setting of parameter o2-04.

Table B.3 208/240VAC Drives											
Drive Model CIMR-____	Nominal Hp	Factory Default for b8-04	Factory Default for C6-02	Factory Default for E2-01	Factory Default for E2-03	Factory Default for E2-05	Factory Default for L2-02	Factory Default for L2-03	Factory Default for L2-04	Factory Default for L8-02	Factory Default for L8-06
P7U20P4	0.5/0.75	288.2	10kHz	1.9	1.2	9.842	0.1	0.1	0.3	95° C	5
P7U20P7	2	223.7	10kHz	3.3	1.8	5.156	0.1	0.2	0.3	95° C	7.5
P7U21P5	1.5/2	169.4	10kHz	6.2	2.8	1.997	0.2	0.3	0.3	95° C	10
P7U22P2	3	156.8	8kHz	8.5	3.0	1.601	0.3	0.4	0.3	100° C	12
P7U23P7	5	122.9	10kHz	14.0	4.5	0.771	0.5	0.5	0.3	95° C	12
P7U25P5	7.5	94.75	15kHz	19.6	5.1	0.399	1.0	0.6	0.3	95° C	10
P7U27P5	10	72.69	15kHz	26.6	8.0	0.288	1.0	0.7	0.3	95° C	17
P7U2011	15	70.44	8kHz	39.7	11.2	0.230	1.0	0.8	0.3	95° C	21
P7U2015	20	63.13	10kHz	53.0	15.2	0.138	2.0	0.9	0.3	90° C	17
P7U2018	25	57.87	10kHz	65.8	15.7	0.101	2.0	1.0	0.6	100° C	15
P7U2022	30	51.79	10kHz	77.2	18.5	0.079	2.0	1.0	0.6	90° C	24
P7U2030	40	46.27	10kHz	105.0	21.9	0.064	2.0	1.1	0.6	90° C	20
P7U2037	50	38.16	5kHz	131.0	38.2	0.039	2.0	1.1	0.6	95° C	18
P7U2045	60	35.78	5kHz	160.0	44.0	0.030	2.0	1.2	0.6	100° C	20
P7U2055	75	31.35	8kHz	190.0	45.6	0.022	2.0	1.2	0.1	105° C	17
P7U2075	75/100	23.10	2kHz	260.0	72.0	0.023	2.0	1.3	0.1	110° C	16
P7U2090	125	20.65	2kHz	260.0	72.0	0.023	2.0	1.5	0.1	100° C	18
P7U2110	150	18.12	2kHz	260.0	72.0	0.023	2.0	1.7	0.1	95° C	20

Note: b8-04 = Energy Savings Coefficient
C6-02 = Carrier Frequency
E2-01 = Motor Rated Current
E2-03 = Motor No-Load Current
E2-05 = Motor Line-to-Line Resistance
L2-02 = Momentary Power Loss Ride-Thru Time
L2-03 = Momentary Power Loss Minimum Base Block Time
L2-04 = Momentary Power Loss Voltage Recovery Ramp Time
L8-02 = Overheat Pre-Alarm Level
L8-06 = Input Phase Loss Detection Level

Table B.4 480VAC Drives

Drive Model CIMR-____	Nominal Hp	Factory Default for b8-04	Factory Default for C6-02	Factory Default for E2-01	Factory Default for E2-03	Factory Default for E2-05	Factory Default for L2-02	Factory Default for L2-03	Factory Default for L2-04	Factory Default for L8-02	Factory Default for L8-06
P7U40P4	0.5/0.75	576.40	15kHz	1.0	0.6	38.198	0.1	0.1	0.3	95°C	5
P7U40P7	1	447.40	15kHz	1.6	0.8	22.459	0.1	0.2	0.3	95°C	7.5
P7U41P5	1.5/2	338.80	15kHz	3.1	1.4	10.100	0.2	0.3	0.3	95°C	10
P7U42P2	3	313.60	15kHz	4.2	1.5	6.495	0.3	0.4	0.3	90 °C	10
P7U43P7	5	245.80	15kHz	7.0	2.3	3.333	0.5	0.5	0.3	95°C	12
P7U45P5	7.5	189.50	15kHz	13.3	2.6	1.595	1.0	0.6	0.3	95°C	10
P7U47P5	10	145.38	15kHz	19.9	4.0	1.152	1.0	0.7	0.3	90°C	20
P7U4011	15/20	140.88	8kHz	26.5	5.6	0.922	2.0	0.8	0.3	95°C	23
P7U4015	25	126.26	10kHz	32.9	7.6	0.550	2.0	0.9	0.3	95°C	17
P7U4018	30	115.74	10kHz	52.3	7.8	0.403	2.0	1.0	0.6	98°C	17
P7U4030	40/50	92.54	8kHz	65.6	10.9	0.269	2.0	1.1	0.6	85°C	20
P7U4037	60	76.32	8kHz	79.7	19.1	0.155	2.0	1.1	0.6	85°C	20
P7U4045	75	71.56	8kHz	95.0	22.0	0.122	2.0	1.2	0.6	90°C	20
P7U4055	100	67.20	5kHz	130.0	24.0	0.088	2.0	1.2	1.0	90°C	20
P7U4075	125	46.20	5kHz	130.0	36.0	0.092	2.0	1.3	1.0	98°C	16
P7U4090	150	38.91	8kHz	156.0	40.0	0.056	2.0	1.5	1.0	108°C	16
P7U4110	200	36.23	5kHz	190.0	49.0	0.046	2.0	1.7	1.0	100°C	16
P7U4160	250	30.13	5kHz	270.0	70.0	0.029	2.0	1.8	1.0	108°C	14
P7U4185	300/350	30.57	2kHz	310.0	81.0	0.025	2.0	0.7	1.0	95°C	15
P7U4220	400/450	27.13	2kHz	370.0	96.0	0.020	2.0	0.8	1.0	100°C	15
P7U4300	500+	21.76	2kHz	500.0	130.0	0.014	2.1	0.9	1.0	95°C	15

Note: b8-04 = Energy Savings Coefficient

C6-02 = Carrier Frequency

E2-01 = Motor Rated Current

E2-03 = Motor No-Load Current

E2-05 = Motor Line-to-Line Resistance

L2-02 = Momentary Power Loss Ride-Thru Time

L2-03 = Momentary Power Loss Minimum Base Block Time

L2-04 = Momentary Power Loss Voltage Recovery Ramp Time

L8-02 = Overheat Pre-Alarm Level

L8-06 = Input Phase Loss Detection Level

Notes:

Appendix C Specifications

This appendix details the standard Drive Specifications.

Standard Drive and Bypass Specifications	2
208-240 VAC	2
480 VAC	3
All Voltages	4

Standard Drive and Bypass Specifications

The standard Drive and Bypass specifications are listed in the following tables.

◆ 208-240 VAC

Bypass Model Number P7B_*		D003	D004	D007	D010	D016	D024	D030	D046	D059	D074	D088	D114
Motor HP	208V	0.5/0.75	1	1.5/2	3	5	7.5	10	15	20	25	30	40
	240V	0.5/0.75	1	1.5/2	3	5	7.5	10	15	20	25	30	40
Bypass rated output current (A)		3.5	4.6	7.5	10.6	16.7	24.2	30.8	46.2	59.4	74.8	88	114
Drive Model Number CIMR-P7U		20P4	20P7	21P5	22P2	23P7	25P5	27P5	2011	2015	2018	2022	2030
Drive rated output capacity (kVA)		1.4	1.8	3.0	4.1	6.4	8.8	12.0	18.0	23.0	29.0	34.0	44.0
Drive rated output current (A)		3.6	4.6	7.8	10.8	16.8	23.0	31.0	46.2	59.4	74.8	88.0	115.0
Drive max. output voltage (V)		3-phase; 200, 208, 220, 230, or 240VAC (Proportional to input voltage)											
Drive max. output frequency (Hz)		120 Hz											
Power supply characteristics	Rated voltage (V)	3-phase, 200/208/220/230/240VAC, 50/60 Hz											
	Rated frequency (Hz)	3-phase, 200/208/220/230/240VAC, 50/60 Hz											
	Rated input current (A)	4.3	5.5	9.4	13	20	24	37	53	70	89	98	120
	Allowable voltage fluctuation	+ 10%, - 15%											
	Allowable frequency fluctuation	±5%											
Control characteristics	Measures for power supply harmonics	DC Reactor	Optional										Built-in
		12-Pulse Rectification	Not possible										Possible

Bypass Model Number P7B_*		D143	D169	D211	D273	D343	D396
Motor HP	208V	50	60	75	100	125	150
	230V	50/60	75	-	100/125	150	-
Bypass rated output current (A)		143	169	211	273	343	396
Drive Model Number CIMR-P7U		2037	2045	2055	2075	2090	2110
Drive rated output capacity (kVA)		62.0	73.0	82	120.0	140.0	160.0
Drive rated output current (A)		162.0	192.0	215	312.0	360.0	415.0
Drive max. output voltage (V)		3-phase; 200, 208, 220, 230, or 240VAC (Proportional to input voltage)					
Drive max. output frequency (Hz)		120 Hz					
Power supply characteristics	Rated voltage (V)	3-phase, 200/208/220/230/240VAC, 50/60 Hz					
	Rated frequency (Hz)	3-phase, 200/208/220/230/240VAC, 50/60 Hz					
	Rated input current (A)	180	212	237	350	396	457
	Allowable voltage fluctuation	+ 10%, - 15%					
	Allowable frequency fluctuation	±5%					
Control characteristics	Measures for power supply harmonics	DC Reactor	Built-in				
		12-Pulse Rectification	Possible				

Note: The maximum applicable motor output is given for a standard 4-pole motor. When selecting the actual motor and Drive, be sure that the Bypass and Drive's rated output current is equal to, or greater than, the motor's rated current.

A phase-shifting transformer is required on the power supply for 12-pulse rectification.

* Only 208V model numbers are shown.

◆ 480 VAC

Table C.3 480VAC Drive and Bypass Specifications

Bypass Model Number P7B_*		B001	B002	B003	B004	B007	B011	B014	B021/B027	B034	B040
Motor HP (460V)		0.5/0.75	1	1.5/2	3	5	7.5	10	15/20	25	30
Bypass rated output current (A)		1.6	2.1	3.4	4.8	7.6	11	14	21/27	34	40
Drive Model Number CIMR-P7U		40P4	40P7	41P5	42P2	43P7	45P5	47P5	4011	4015	4018
Drive rated output capacity (kVA)		1.4	1.6	2.8	4.0	5.8	9.5	13.0	21.0	26.0	30.0
Drive rated output current (A)		1.8	2.1	3.7	5.3	7.6	12.5	17.0	27.0	34.0	40.0
Drive max. output voltage (V)		3-phase; 380, 400, 415, 440, 460, or 480VAC (Proportional to input voltage.)									
Drive max. output frequency (Hz)		120 Hz									
Power supply characteristics	Rated voltage (V) Rated frequency (Hz)	3-phase, 380, 400, 415, 440, 460 or 480VAC, 50/60 Hz									
	Rated input current (A)	2.2	2.5	4.4	6.4	9.0	15	20	33	40	48
	Allowable voltage fluctuation	+ 10%, - 15%									
	Allowable frequency fluctuation	±5%									
Control characteristics	Measures for power supply harmonics	DC Reactor	Optional								
		12-pulse Rectification	Not possible								

Table C.3 480VAC Drive Specifications (Continued)

Bypass Model Number P7B_*		B052/B065	B077	B096	B124	B156	B180	B240	B302	-	-	-
Motor HP (460V)		40/50	60	75	100	125	150	200	250	300/350	400/450	500+
Bypass rated output current (A)		52/65	77	96	124	156	180	240	302			
Drive Model Number CIMR-P7U		4030	4037	4045	4055	4075	4090	4110	4160	4185	4220	4300
Drive rated output capacity (kVA)		51.0	59.0	73.0	95.0	120.0	140.0	180.0	230.0	315.0	390.0	510.0
Drive rated output current (A)		67.2	77.0	96.0	125.0	156.0	180.0	240.0	304.0	414.0	515.0	675.0
Drive max. output voltage (V)		3-phase, 380, 400, 415, 440, 460 or 480VAC (Proportional to input voltage)										
Drive max. output frequency (Hz)		120 Hz										
Power supply characteristics	Max. voltage (V) Rated frequency (Hz)	3-phase, 380, 400, 415, 440, 460, or 480VAC, 50/60 Hz										
	Rated input current (A)	74	85	106	134	172	198	264	334	456	567	743
	Allowable voltage fluctuation	+ 10%, - 15%										
	Allowable frequency fluctuation	±5%										
Control characteristics	Measures for power supply harmonics	DC Reactor	Built-in									
		12-Pulse Rectification	Possible									

Note: The maximum applicable motor output is given for a standard 4-pole motor. When selecting the actual motor and Drive, be sure that the Bypass and Drive's rated output current is equal to, or greater than, the motor's rated current.

A 3-wire phase-shifting transformer is required on the power supply for 12-pulse rectification.

◆ All Voltages

Table C.4 Common Drive Specifications

All Models		Specification
Control Characteristics	Control method	Sine wave PWM V/f control
	Speed range	40:1
	Speed control accuracy	±2 to 3% (77°F ± 50°F) (25°C ± 10°C)
	Frequency accuracy (temperature characteristics)	Digital references: ± 0.01% (14°F to 104°F) (-10°C to +40°C)
		Analog references: ±0.1% (77°F ± 50°F) (25°C ± 10°C)
	Frequency setting resolution	Digital references: 0.01 Hz
		Analog references: 0.025/50 Hz (10 bit with sign)
	Frequency setting signal (Speed Command)	0-10 Vdc, 4-20 mA
	Acceleration/Deceleration time	0.0 to 6000.0 s (2 selectable combinations of independent acceleration and deceleration settings)
Main Drive control functions	Restarting for momentary power loss, bi-directional speed search, overtorque detection, 5 preset speeds, acceleration/deceleration time changes, S-curve acceleration, 3-wire sequence, auto-tuning, cooling fan ON/OFF control, torque compensation, jump frequencies, upper and lower limits for frequency references, DC braking for starting and stopping, high-slip braking, PI control (with sleep function), energy-saving control, Modbus communications (RS-485/422, 19.2 kbps maximum), fault reset, and copy function	
Main Bypass control functions	Provides an alternate connection for the motor to line power for operation at full speed only, directly from line power. Three electrically interlocked IEC rated contactors isolate the Drive when operating in Bypass mode. Control logic circuit provides Hand/Off/Auto functions and safety circuit interlocks. Includes fused 120VAC control transformer, motor circuit protector/disconnect, motor overload relay, selector switches and indicating lights.	
Protective Functions	Motor protection	Protection by electronic thermal overload relay
	Fuse blown protection	Stops for fuse blown
	Overload capacity and maximum current	110% of rated output current for 60 seconds
	Overvoltage protection	208-240VAC: Stops when main-circuit DC voltage is above 410 V 480VAC: Stops when main-circuit DC voltage is above 820 V
	Undervoltage protection	208-240VAC: Stops when main-circuit DC voltage is below 190 V 480VAC: Stops when main-circuit DC voltage is below 380 V
	Momentary power loss ride thru	Power Interruptions of 15 ms or more By selecting the momentary power loss method, operation can be continued if power is restored within 2 s
	Cooling fin overheating	Protection by thermistor
	Stall prevention	Stall prevention during acceleration, deceleration, or running
	Grounding protection	Protection by electronic circuits. (50% of inverter rated current)
Charge indicator	Lit when the main circuit DC voltage is approx. 50 Vdc or more	
Enclosure Type		Enclosed wall-mounted type (NEMA 1): CIMR-P7U20P4 thru 2030 and 40P4 thru 4055 Open chassis type (IP00): CIMR-P7U2022 thru 2110 and 4030 thru 4300
Environment	Ambient operating temperature	14°F to 104°F (-10°C to 40°C) NEMA 1 type 14°F to 113°F (-10°C to 45°C) Open chassis type
	Ambient operating humidity	95% max. (with no condensation)
	Storage temperature	68°F to 140°F (- 20°C to + 60°C) short-term temperature during transportation
	Application site	Indoor (no corrosive gas, dust, etc.)
	Altitude	3300 ft. (1000 m), higher altitudes by derate
Vibration	10 to 20 Hz, 32 ft/sec ² (9.8 m/s ²) max.; 20 to 50 Hz, 6.5 ft/sec ² (2 m/s ²) max.	

Appendix D

Communication

This appendix details the specifications, connections, and programming of the Drive for Modbus communications.

The H/O/A switch must be in the AUTO position if serial communication is to be used for P7 Drive run, stop and speed control.

Using Modbus Communication	2
Modbus Communication Configuration	2
Communication Specifications	2
Communication Connection Terminal	3
Procedure for Setting Up Communication	3
Modbus Function Code Details	7
Reading/Holding Register Contents (03H)	7
Write In Single Holding Register (06H)	7
Loopback Test (08H)	8
Write In Several Holding Registers (10H)	8
Modbus Data Tables	9
Reference Data	9
Monitor Data	10
Modbus Self-Diagnosis	14

Using Modbus Communication

Serial communication can be performed with Direct Digital Controllers (DDCs) or similar devices using the Modbus protocol.

◆ Modbus Communication Configuration

Modbus communication is configured using 1 master (PLC) and a maximum of 31 slaves. Serial communication between master and slave is normally initiated by the master and responded to by the slaves.

The master performs serial communication with one slave at a time. Consequently, the slave address of each slave must be initially set, so that the master can perform serial communication using that address. Slaves receiving commands from the master perform the specified functions, and send a response back to the master.

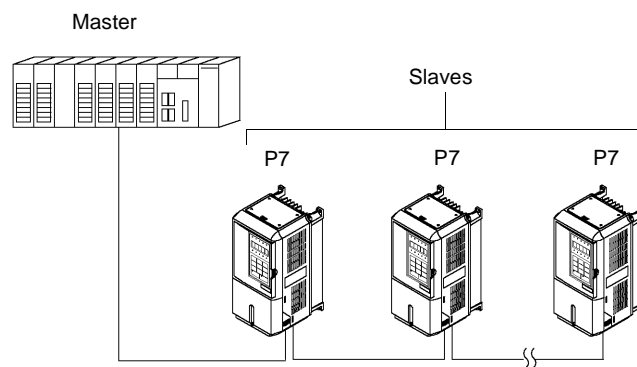

Fig D. 1 Example of Connections between Master and Drive

◆ Communication Specifications

The Modbus communication specifications are shown below:

Item	Specifications
Interface	RS-422, RS-485
Communications Cycle	Asynchronous (Start-stop synchronization)
Communications Parameters	Baud rate: Select from 1200, 2400, 4800, 9600, and 19200 bps. Data length: 8 bits fixed Parity: Select from even, odd, or none. Stop bits: 1 bit selected
Communications Protocol	Modbus
Number of Connectable Units	31 units max.

◆ Communication Connection Terminal

Modbus communication uses the following terminals: S+, S-, R+, and R-. The terminating resistance must be turned ON only if the Drive is at the very end of the Serial Communication chain. Set the terminating resistance by turning ON pin 1 of switch S1.

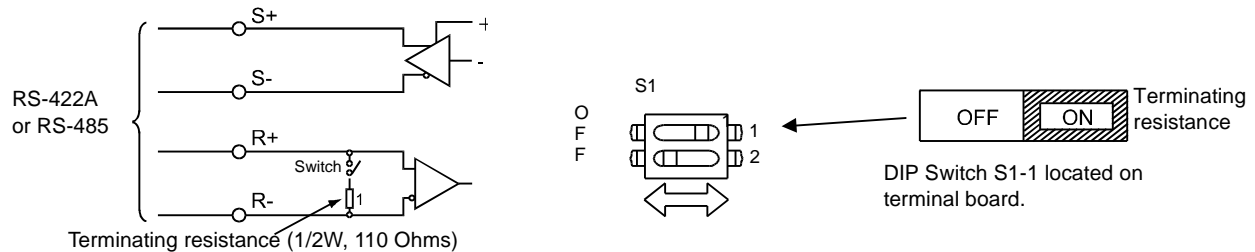

Fig. D.2 Communication Connection Terminals and Terminating Resistance

IMPORTANT

1. Separate the communication cables from the main circuit cables and control circuit wiring.
2. Use shielded cables for the communication cable, and use proper shield clamps.
3. When using RS-485 communication, connect S+ to R+, and S- to R-, on the control circuit terminal board. See Fig. D-3 below.
4. Shield at one end only.

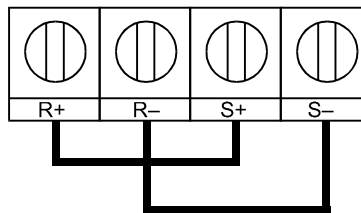

Fig. D.3 RS-485 Communication Connection

◆ Procedure for Setting Up Communication

Use the following procedure to perform communication with the PLC.

1. Turn OFF the input to the Drive power and connect the communication cable between the PLC and the Drive.
2. Turn ON the input power to the Drive.
3. Set the required communication parameters (H5-01 to H5-09) using the Digital Operator.
4. Turn OFF the input to the Drive power, and check that the Digital Operator display has completely disappeared.
5. Turn ON the input power to the Drive once again.
6. Perform communication with the PLC.

■ Related Parameters

Table D.2 Serial Communication Related Parameters						
Parameter No.	Parameter Name Digital Operator Display	Description	Setting Range	Factory Setting	Chapter Ref #	Menu Location
b1-01	Frequency Reference Selection Reference Source	Selects the speed command (frequency reference) input source. 0: Operator - Digital preset speed d1-01 1: Terminals - Analog Input Terminal A1 (or Terminal A2 see parameter H3-13) 2: Serial Com - RS-485 terminals R+, R-, S+ and S- 3: Option PCB - Option board connected at 2CN	0 to 3	1		Quick Setting
b1-02	Run Command Selection Run Source	Selects the run command input source. 0: Operator - "Hand" and "Off" keys on digital operator 1: Terminal - Contact Closure on Terminal S1 2: Serial Com - RS-485 terminals R+, R-, S+ and S- 3: Option PCB - Option board connected at 2CN	0 to 3	1		Quick Setting
H5-01	Drive Node Address Serial Com Adr	Selects Drive station node number (address) for terminals R+, R-, S+, S-.* * Set H5-01 to 0 to disable Drive responses to Modbus communications.	0 to FF (H5-08 dependent)	1F		Programming
H5-02	Communication Speed Selection Serial Baud Rate	Selects the baud rate for terminals R+, R-, S+ and S-.* 0: 1200 Baud 1: 2400 Baud 2: 4800 Baud 3: 9600 Baud 4: 19200 Baud	0 to 4	3		Programming
H5-03	Communication Parity Selection Serial Com Sel	Selects the communication parity for terminals R+, R-, S+ and S-.* 0: No Parity 1: Even Parity 2: Odd Parity	0 to 2	0		Programming
H5-04	Stopping Method after Communication Error Serial Fault Sel	Selects the stopping method when a communication error is detected. 0: Ramp to Stop 1: Coast to Stop 2: Fast-Stop 3: Alarm Only 4: Run at D1-04	0 to 3	3		Programming
H5-05	Communication Error Detection Selection Serial Flt Dtct	Enables or disables the communications timeout detection function. 0: Disabled - A communications loss will NOT cause a communications fault. 1: Enabled - If communications is lost for more than the time specified in parameter H5-09, a communications fault will occur.	0 or 1	1		Programming
H5-06	Drive Transmit Wait Time Transmit WaitTIM	Sets the time from when the Drive receives data to when the Drive sends data.	5 to 65	5ms		Programming
H5-07	RTS Control Selection RTS Control Sel	Enables or disables request to send (RTS) control: 0: Disabled 1: Enabled	0 or 1	1		Programming
H5-08	Communication Protocol Selection Protocol Select	Selects the communication protocol. 0: Modbus		0		Programming
H5-09	Communication Error Detection Time CE Detect Time	Determines how long communications must be lost before a fault is annunciated. Works in conjunction with parameters H5-05 and H5-04.	0.0 to 10.0	2.0sec		Programming

* After these parameters are changed Drive power must be cycled before the changes will take effect.

Modbus communication can perform the following operations regardless of the settings in b1-01 and b1-02:

1. Monitoring operation status of the Drive
2. Setting and reading Drive parameters
3. Resetting faults
4. Input multi-function commands

IMPORTANT

An OR operation is performed between the multi-function command input from the DDC and the command input from multi-function digital input terminals S3 to S7.

■ Message Format

In Modbus communication, the master sends commands to the slave, and the slave responds. The message format is configured for both sending and receiving as shown below. The length of the data packets is changed by the command (function) contents.

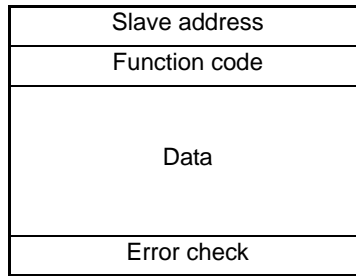

Fig. D.4 Message Format

The space between messages must support the following:

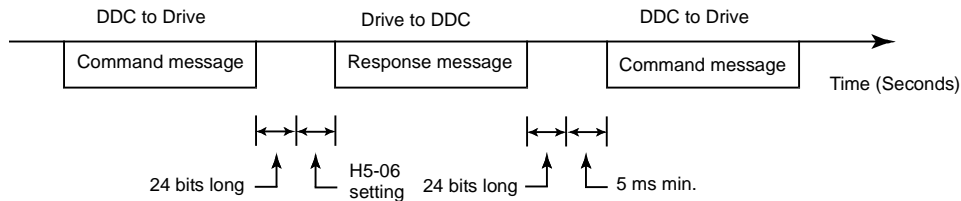

Fig. D.5 Message Spacing

Slave Address

Set the Drive address from 0 to 32. If 0 is selected, commands from the master will be broadcast (i.e., the Drive will not return responses).

Function Code

The function code specifies commands. There are four function codes, as shown below.

Function Code (Hexadecimal)	Function	Command Message		Response Message	
		Min. (Bytes)	Max. (Bytes)	Min.* (Bytes)	Max. (Bytes)
03H	Reading/Holding Register Contents	8	8	7	37
06H	Write In Single Holding Register	8	8	8	8
08H	Loopback Test	8	8	8	8
10H	Write In Several Holding Registers	11	41	8	8

* Minimum bytes for a normal Response Message (error response message is always 5 bytes).

Data

Configure consecutive data by combining the storage register address (test code for a loopback address) and the data the register contains. The data length changes depending on the command details.

Error Check

Errors are detected during communication using CRC-16. Perform calculations using the following method:

1. The factory setting for CRC-16 communication is typically zero, but when using the Modbus system, set the factory setting to one (e.g., set all 16 bits to 1).
2. Calculate CRC-16 using MSB as slave address LSB, and LSB as the MSB of the final data.
3. Calculate CRC-16 for response messages from the slaves and compare them to the CRC-16 in the response messages.

Modbus Function Code Details

◆ Reading/Holding Register Contents (03H)

Read the contents of the storage register only for specified quantities. The addresses must be consecutive, starting from a specified address. The data content of the storage register are separated into higher 8 bits and lower 8 bits.

The following table shows message examples when reading status signals, error details, data link status, and frequency references from the slave 2 Drive.

Command Message			Response Message (During Normal Operation)			Response Message (During Error)		
Slave Address		02H	Slave Address		02H	Slave Address		02H
Function Code		03H	Function Code		03H	Function Code		83H
Start Address	Higher	00H	Data quantity		08H	Error code		03H
	Lower	20H	1st storage register	Higher	00H	CRC-16	Higher	F1H
Quantity	Higher	00H		Lower	65H		Lower	31H
	Lower	04H	Next storage register	Higher	00H			
CRC-16	Higher	45H		Lower	00H			
	Lower	F0H	Next storage register	Higher	00H			
				Lower	00H			
			Next storage register	Higher	01H			
				Lower	F4H			
			CRC-16	Higher	AFH			
				Lower	82H			

Fig. D.6 Function Code 03H Message Example

◆ Write In Single Holding Register (06H)

Command Message			Response Message (During Normal Operation)			Response Message (During Error)		
Slave Address		01H	Slave Address		01H	Slave Address		01H
Function Code		06H	Function Code		06H	80H + Function Code		86H
Register Address	Upper	00H	Register Address	Upper	00H	Error code		21H
	Lower	01H		Lower	01H	CRC-16	Upper	82H
Setting Data	Upper	00H	Setting Data	Upper	00H		Lower	78H
	Lower	03H		Lower	03H			
CRC-16	Upper	98H	CRC-16	Upper	98H			
	Lower	0BH		Lower	0BH			

Fig. D.7 Function Code 06H Message Example

◆ Loopback Test (08H)

The loopback test returns the command message directly as the response message without changing the contents to check the communications between the master and slave. Set user-defined test code and data values.

The following table shows a message example when performing a loopback test with the slave 1 Drive.

Command Message			Response Message (During Normal Operation)			Response Message (During Error)		
Slave address		01H	Slave address		01H	Slave address		01H
Function code		08H	Function code		08H	Function code		89H
Test Code	Higher	00H	Test Code	Higher	00H	Error Code		01H
	Lower	00H		Data	Lower	00H	CRC-16	Higher
Data	Higher	A5H	Data		Higher	A5H		CRC-16
	Lower	37H		CRC-16	Lower	37H		
CRC-16	Higher	DAH	CRC-16		Higher	DAH		
	Lower	8DH		CRC-16	Lower	8DH		

Fig. D.8 Function Code 08H Message Example

◆ Write In Several Holding Registers (10H)

Write the specified data to the registers from the specified addresses. The written data must be consecutive, starting from the specified address in the command message: Higher 8 bits, then lower 8 bits, in storage register address order.

The following table shows an example of a message when a forward run command has been set at a speed command of 60.0 Hz in the slave 1 Drive by the PLC.

Command Message			Response Message (During Normal Operation)			Response Message (During Error)		
Slave Address		01H	Slave Address		01H	Slave Address		01H
Function Code		10H	Function Code		10H	Function Code		90H
Start Address	Higher	00H	Start Address	Higher	00H	Error code		02H
	Lower	01H		Quantity	Lower	01H	CRC-16	Higher
Quantity	Higher	00H	Quantity		Higher	00H		CRC-16
	Lower	02H		CRC-16	Lower	02H		
No. of data		04H	CRC-16		Higher	10H		
Lead data	Higher	00H		CRC-16	Lower	08H		
	Lower	01H						
Next data	Higher	02H						
	Lower	58H						
CRC-16	Higher	63H						
	Lower	39H						

* No. of data = 2 x (quantity)

Fig. D.9 Function Code 10H Message Example

IMPORTANT

Set the number of data specified using command messages as quantity of specified messages x 2. Handle response messages in the same way.

Modbus Data Tables

The data tables are shown below. The types of data are as follows: Reference data, monitor data and broadcast data.

◆ Reference Data

The reference data table is shown below. Reference data can be read and written to.

Table D.4 Reference Data		
Register No.	Contents	
0000H	Reserved	
0001H	Frequency reference	
	Bit 0	Run/stop command 1: Run 0: Stop
	Bit 1	Forward/reverse operation 1: Reverse 0: Forward
	Bit 2	External fault 1: Fault (EFO)
	Bit 3	Fault reset 1: Reset command
	Bit 4	ComNet
	Bit 5	ComCtrl
	Bit 6	Multi-function digital input command 3
	Bit 7	Multi-function digital input command 4
	Bit 8	Multi-function digital input command 5
	Bit 9	Multi-function digital input command 6
	Bit A	Multi-function digital input command 7
Bits B to F	Not used	
0002H	Frequency reference (Set units using parameter o1-03)	
0003H to 0005H	Not used	
0006H	PI Setpoint	
0007H	Analog output 1 setting (-11 V = 726 to 11 V = 726) → 10V = 660	
0008H	Analog output 2 setting (-11 V = 726 to 11 V = 726) → 10V = 660	
0009H	Multi-function contact output setting	
	Bit 0	Digital output 1 (Terminal M1-M2) 1: ON 0: OFF
	Bit 1	Digital output 2 (Terminal M3-M4) 1: ON 0: OFF
	Bit 2	Not Used
	Bits 3 to 5	Not used
	Bit 6	Set fault contact (terminal MA-MC) output using bit 7. 1: ON 0: OFF
	Bit 7	Fault contact (terminal MA-MC) 1: ON 0: OFF
Bits 8 to F	Not used	
000AH to 000EH	Not used	
000FH	Reference selection settings	
	Bit 0	Not used
	Bit 1	Input PI setpoint 1: Enabled 0: Disabled
	Bits 3 to B	Not used
	C	Broadcast data terminal S5 input 1: Enabled 0: Disabled
	D	Broadcast data terminal S6 input 1: Enabled 0: Disabled
	E	Broadcast data terminal S7 input 1: Enabled 0: Disabled
F	Not used	

Note: Write 0 to all unused bits. Also, do not write data to reserved registers.

◆ Monitor Data

The following table shows the monitor data. Monitor data can only be read.

Table D.5 Monitor Data		
Register No.	Contents	
0020H	Drive status	
	Bit 0	Operation 1: Operating 0: Stopped
	Bit 1	Reverse operation 1: Reverse operation 0: Forward operation
	Bit 2	Drive startup complete 1: Completed 0: Not completed
	Bit 3	Fault 1: Fault
	Bit 4	Data setting error 1: Error
	Bit 5	Multi-function digital output 1 (terminal M1 - M2) 1: ON 0: OFF
	Bit 6	Multi-function digital output 2 (terminal M3 - M4) 1: ON 0: OFF
	Bit 7	Not used
	Bits 8 to F	Not used
0021H	Fault details	
	Bit 0	Overcurrent (OC) Ground fault (GF)
	Bit 1	Main circuit overvoltage (OV)
	Bit 2	Drive overload (OL2)
	Bit 3	Drive overheat (OH1, OH2)
	Bit 4	Not used
	Bit 5	Fuse blown (PUF)
	Bit 6	PI feedback reference lost (FbL)
	Bit 7	External error (EF, EFO)
	Bit 8	Hardware error (CPF)
	Bit 9	Motor overload (OL1) or overtorque 1 (OL3) detected
	Bit A	PG broken wire detected (PGO), Overspeed (OS), Speed deviation (DEV)
	Bit B	Main circuit undervoltage (UV) detected
	Bit C	Main circuit undervoltage (UV1), control power supply error (UV2), inrush prevention circuit error (UV3), power loss
Bit D	Missing output phase (LF)	
Bit E	Modbus communications error (CE)	
Bit F	Operator disconnected (OPR)	
0022H	Data link status	
	Bit 0	Writing data
	Bit 1	Not used
	Bit 2	Not used
	Bit 3	Upper and lower limit errors
	Bit 4	Data integrity error
	Bits 5 to F	Not used
0023H	Frequency reference	U1-01
0024H	Output frequency	U1-02
0025H	Output voltage reference	U1-06
0026H	Output current	U1-03
0027H	Output power	U1-08
0028H	Torque reference	U1-09
0029H	Not used	
002AH	Not used	

Table D.5 Monitor Data (Continued)

Register No.	Contents	
002BH	Sequence input status	
	Bit 0	Input terminal S1 1: ON 0: OFF
	Bit 1	Input terminal S2 1: ON 0: OFF
	Bit 2	Multi-function digital input terminal S3 1: ON 0: OFF
	Bit 3	Multi-function digital input terminal S4 1: ON 0: OFF
	Bit 4	Multi-function digital input terminal S5 1: ON 0: OFF
	Bit 5	Multi-function digital input terminal S6 1: ON 0: OFF
	Bit 6	Multi-function digital input terminal S7 1: ON 0: OFF
	Bits 7 to F	Not used
002CH	Drive status	
	Bit 0	Operation 1: Operating
	Bit 1	Zero speed 1: Zero speed
	Bit 2	Frequency agree 1: Matched
	Bit 3	Desired frequency agree 1: Matched
	Bit 4	Frequency detection 1 1: Output frequency \leq L4-01
	Bit 5	Frequency detection 2 1: Output frequency \geq L4-01
	Bit 6	Drive startup completed 1: Startup completed
	Bit 7	Low voltage detection 1: Detected
	Bit 8	Baseblock 1: Drive output baseblock
	Bit 9	Frequency reference mode 1: Not communication 0: Communication
	Bit A	Run command mode 1: Not communication 0: Communication
	Bit B	Overtorque detection 1: Detected
	Bit C	Frequency reference lost 1: Lost
	Bit D	Retrying error 1: Retrying
	Bit E	Error (including Modbus communications time-out) 1: Error occurred
Bit F	Modbus communications time-out 1: Timed out	
002DH	Multi-function digital output status	
	Bit 0	Multi-function digital output 1 (terminal M1-M2) 1: ON 0: OFF
	Bit 1	Multi-function digital output 2 (terminal M3-M4): 1: ON 0: OFF
	Bit 2	Not used
	Bits 3 to F	Not used
002EH - 0030H	Not used	
0031H	Main circuit DC voltage	
0032H - 0037H	Not used	
0038H	PI feedback level (Input equivalent to 100%/Max. output frequency; 10/1%; without sign)	
0039H	PI input level ($\pm 100\%$ / \pm Max. output frequency; 10/1%; with sign)	
003AH	PI output level ($\pm 100\%$ / \pm Max. output frequency; 10/1%; with sign)	
003BH	CPU software number	
003CH	Flash software number	
003DH	Communication error details	
	Bit 0	CRC error
	Bit 1	Invalid data length
	Bit 2	Not used
	Bit 3	Parity error
	Bit 4	Overrun error
	Bit 5	Framing error
	Bit 6	Time-out
	Bits 7 to F	Not used
003EH	KVA setting	
003FH	Control method	

Note: Communication error details are stored until an error reset is input (errors can be reset while the Drive is operating).

■ Broadcast Data

The following table shows the broadcast data. Broadcast data can be written to.

Table D.6 Broadcast Data		
Register Address	Contents	
0001H	Operation signal	
	Bit 0	Run command 1: Operating 0: Stopped
	Bit 1	Reverse operation command 1: Reverse 0: Forward
	Bits 2 and 3	Not used
	Bit 4	External error 1: Fault (set using H1-01)
	Bit 5	Error Fault 1: Reset command (set using H1-02)
	Bits 6 to B	Not used
	Bit C	Multi-function digital input terminal S5 input
	Bit D	Multi-function digital input terminal S6 input
	Bit E	Multi-function digital input terminal S7 input
0002H	Bit F	Not used.
	Frequency reference	30000/100%

Note: Bit signals not defined in the broadcast operation signals use local node data signals continuously.

■ Enter Command

When writing parameters to the Drive from the PLC using Modbus communication, the parameters are temporarily stored in the constant data area in the Drive. To enable these parameters in the parameter data area, use the Enter command.

There are two types of Enter commands:

1. Enter commands that enable parameter data in RAM
2. Enter commands that write data to EEPROM (non-volatile memory) in the Drive at the same time as enabling data in RAM.

The following table shows the Enter command data. Enter command data can only be written.

The Enter command is enabled by writing 0 to register number 0900H or 0901H.

Table D.7 Enter Command	
Register No.	Contents
0900H	Write parameter data to EEPROM
0910H	Parameter data is not written to EEPROM, but refreshed in RAM only.

IMPORTANT

The maximum number of times you can write to EEPROM using the Drive is 100,000. Do not frequently execute Enter commands (0900H) written to EEPROM.
The Enter command registers are write-only. Consequently, if reading these registers, the register address will become invalid (Error code: 02H).

■ Error Codes

The following table shows Modbus communication error codes.

Error Code	Contents
01H	Function code error A function code other than 03H, 08H, or 10H has been set by the PLC.
02H	Invalid register number error <ul style="list-style-type: none"> • The register address you are attempting to access is not recorded anywhere. • With broadcast sending, a start address other than 0000H, 0001H, or 0002H has been set.
03H	Invalid quantity error <ul style="list-style-type: none"> • The number of data packets being read or written is outside the range of 1 to 16. • In write mode, the number of data packets in the message is not No. of packets x 2.
21H	Data setting error <ul style="list-style-type: none"> • Upper limit or lower limit error has occurred in the control data or when writing parameters. • When writing parameters, the parameter setting is invalid.
22H	Write mode error <ul style="list-style-type: none"> • Attempting to write parameters to the Drive during run. • Attempting to write via Enter commands during run. • Attempting to write parameters other than A1-00 to A1-05, E1-03, or 02-04 when a CPF03 (defective EEPROM) fault has occurred. • Attempting to write read-only data.
23H	Writing during main circuit undervoltage (UV) fault <ul style="list-style-type: none"> • Writing parameters to the Drive during UV (main circuit undervoltage) alarm. • Writing via Enter commands during UV (main circuit undervoltage) alarm.
24H	Writing error during parameters processing Attempting to write parameters while processing parameters in the Drive.

■ Slave Not Responding

In the following cases, the slave will ignore the write function.

- When a communication error (overrun, framing, parity, or CRC-16) is detected in the command message.
- When the slave address in the command message and the slave address in the Drive do not agree.
- When the data that configures the message and the data time length exceed 24 bits.
- When the command message data length is invalid.

IMPORTANT

If the slave address specified in the command message is 0, all slaves execute the write function, but do not return response messages to the master.

Modbus Self-Diagnosis

The Drive has a built-in function for self-diagnosing the operations of serial communication interface circuits. The self-diagnosis function connects the communication parts of the send and receive terminals, receives the data sent by the Drive, and checks if communication is being performed normally.

Perform the self-diagnosis function using the following procedure.

1. Turn ON the power supply to the Drive, and set parameter H1-05 (Terminal S7 Function Selection) to 67 (Com Test Mode).
2. Turn OFF the power supply to the Drive.
3. Perform wiring according to the following diagram while the power supply is turned OFF.
4. Turn ON the terminating resistance. (Turn ON pin 1 on DIP switch 1.)
5. Turn ON the power supply to the Drive again.

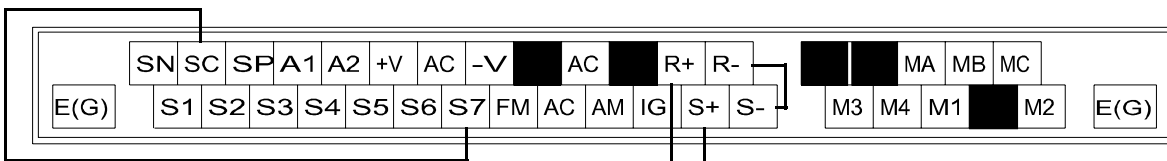

Fig. D.10 Communication Terminal Connection for Self -Diagnosis Function

6. During normal self-diagnostic operation, the Digital Operator displays the frequency reference value. If an error occurs, a CE (Modbus communication error) alarm will be displayed on the Digital Operator, the fault contact output will be turned ON, and the Drive operation ready signal will be turned OFF.

Appendix E

Peripheral Devices

This appendix describes recommended branch short circuit protection and peripheral devices.

General Peripheral Devices	2
Magnetic Contactor	2
AC and DC reactor	2
Noise filter	2

General Peripheral Devices

The following peripheral devices may be required to be mounted between the AC main circuit power supply and the Drive input terminals R/L1, S/L2, and T/L3.

CAUTION

Never connect a general LC/RC noise filter to the Drive output circuit.
Never connect a phase-advancing capacitor to the input or output sides, or a surge suppressor to the output side of the Drive. When magnetic contactor is installed between the Drive and the motor, never turn it on or off during operation.

For more details on peripheral devices, contact the manufacturer.

◆ Magnetic Contactor

Mount a surge protector on the coil. When using a magnetic contactor to start and stop the Drive, do not exceed one start per hour.

◆ AC and DC reactor

Install a reactor to connect to a power supply transformer of large capacity (600 kVA or more) or to improve the power factor on the power supply side.

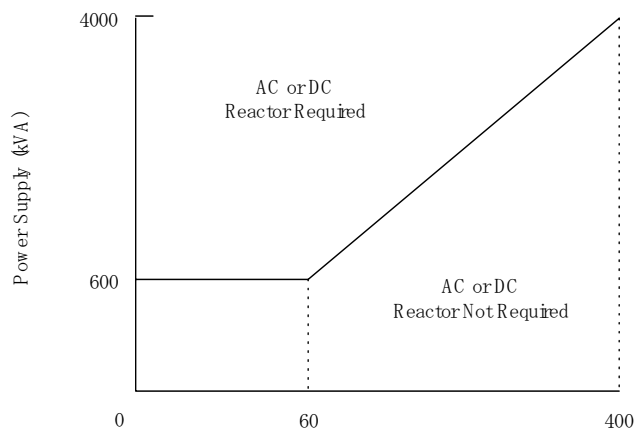

Fig E.1 Connected Drive (kVA)

◆ Noise filter

Use a noise filter exclusively for the Drive if radio noise generated from the Drive causes other control devices to malfunction.

Appendix F Replacement Parts

This appendix lists the primary parts that may be needed to maintain or service the Drive and Bypass unit.

Primary Parts - 208/230/240 VAC 2
Primary Parts - 480 VAC 3
Bypass Replacement Parts 4

Primary Parts - 208/230/240VAC

Table F.1 208-240VAC Primary Parts

Drive Model CIMR-P7U	Nominal Hp	Power PCB (3PCB)	Gate Drive PCB (3PCB)	Control PCB (1PCB)	Terminal PCB (2PCB)	Diode Module
20P4	0.5/0.75	ETP617012	N/A	ETC618021-S3010	ETC618141	Inside the Power Module
20P7	1	ETP617012	N/A	ETC618021-S3010	ETC618141	Inside the Power Module
21P5	1.5/2	ETP617022	N/A	ETC618021-S3010	ETC618141	Inside the Power Module
22P2	3	ETP617032	N/A	ETC618021-S3010	ETC618141	Inside the Power Module
23P7	5	ETP617042	N/A	ETC618021-S3010	ETC618141	Inside the Power Module
25P5	7.5	ETP617052	N/A	ETC618021-S3010	ETC618141	Inside the Power Module
27P5	10	ETP617062	N/A	ETC618021-S3010	ETC618141	Inside the Power Module
2011	15	ETP617422	N/A	ETC618021-S3010	ETC618141	SID003114 (D1)
2015	20	N/A	ETC617032	ETC618021-S3010	ETC618141	SID003113 (D1)
2018	25	N/A	ETC617042	ETC618021-S3010	ETC618141	SID003113 (D1)
2022	30	N/A	ETC617053	ETC618021-S3010	ETC618141	SID003114 (D1,D2)
2030	40	N/A	ETC617063	ETC618021-S3010	ETC618141	SID003113 (D1,D2)
2037	50	N/A	ETC617073	ETC618021-S3010	ETC618141	SID003130 (D1,D2)
2045	60	N/A	ETC617083	ETC618021-S3010	ETC618141	SID003115 (D1,D2)
2055	75	N/A	ETC617093	ETC618021-S3010	ETC618141	SID003115 (D1,D2)
2075	75/100	N/A	ETC617103	ETC618021-S3010	ETC618141	SID003116 (D1,D6)
2090	125	N/A	ETC617113	ETC618021-S3010	ETC618141	SID003116 (D1,D6)
2110	150	N/A	ETC617531	ETC618021-S3010	ETC618141	SID003108 (D1,D12)

Table F.1 208-240VAC Primary Parts (Continued)

Drive Model CIMR-P7U	Nominal Hp	Power Module	Transistor Module	DC Bus Fuse	Heat Sink Fan	Internal Fan
20P4	0.5/0.75	STR001297 (Q1)	Inside the Power Module	FU-002029 (F1)	N/A	N/A
20P7	1	STR001297 (Q1)	Inside the Power Module	FU-002029 (F1)	N/A	N/A
21P5	1.5/2	STR001299 (Q1)	Inside the Power Module	FU-002029 (F1)	N/A	N/A
22P2	3	STR001301 (Q1)	Inside the Power Module	FU-002030 (F1)	N/A	N/A
23P7	5	STR001303 (Q1)	Inside the Power Module	FU-002031 (F1)	FAN001066 (B1)	N/A
25P5	7.5	STR001304 (Q1)	Inside the Power Module	FU-002099 (F1)	FAN001066 (B1)	N/A
27P5	10	STR001278 (Q1)	Inside the Power Module	FU-002107 (F1)	FAN001066 (B1,B2)	N/A
2011	15	N/A	STR001315 (Q1)	FU-002108 (F1)	FAN001066 (B1,B2)	FAN001043 (B3)
2015	20	N/A	STR001315 (Q1)	FU-002108 (F1)	FAN001065 (B1,B2)	N/A
2018	25	N/A	STR001320 (Q1)	FU-002109 (F1)	FAN001065 (B1,B2)	FAN001043 (B3)
2022	30	N/A	STR001314 (Q1)	FU-002110 (F1)	FAN001039 (B1,B2)	N/A
2030	40	N/A	STR001323 (Q1)	FU-002110 (F1)	FAN001039 (B1,B2)	N/A
2037	50	N/A	STR001293 (Q1-Q3)	FU-002102 (F1)	FAN001049 (B1,B2)	FAN001053 (B4)
2045	60	N/A	STR001335 (Q1-Q3)	FU-000925 (F1)	FAN001049 (B1,B2)	FAN001053 (B4)
2055	75	N/A	STR001335 (Q1-Q3)	FU-000938 (F1)	FAN001052 (B1,B2)	FAN001054 (B4)
2075	75/100	N/A	STR001349 (Q1-Q6)	FU-000926 (F1)	FAN001056 (B1,B2)	FAN001054 (B4)
2090	125	N/A	STR001338 (Q1-Q6)	FU-002105 (F1)	FAN001056 (B1,B2)	FAN001054 (B4)
2110	150	N/A	STR001351 (Q1-Q12)	FU-002106 (F1)	FAN001056 (B1,B2)	FAN001054 (B4)

Primary Parts - 480VAC

Table F.2 480VAC Primary Parts

Drive Model CIMR-P7U	Nominal Hp	Power PCB (3PCB)	Gate Drive PCB (3PCB)	Control PCB (1PCB)	Terminal PCB (2PCB)	Diode Module
40P4	0.5/0.75	ETP617082	N/A	ETC618021-S3010	ETC618141	Inside the Power Module
40P7	1	ETP617082	N/A	ETC618021-S3010	ETC618141	Inside the Power Module
41P5	1.5/2	ETP617092	N/A	ETC618021-S3010	ETC618141	Inside the Power Module
42P2	3	ETP617102	N/A	ETC618021-S3010	ETC618141	Inside the Power Module
43P7	5	ETP617112	N/A	ETC618021-S3010	ETC618141	Inside the Power Module
45P5	7.5	ETP617132	N/A	ETC618021-S3010	ETC618141	Inside the Power Module
47P5	10	ETP617142	N/A	ETC618021-S3010	ETC618141	Inside the Power Module
4011	15/20	ETP617152	N/A	ETC618021-S3010	ETC618141	Inside the Power Module
4015	25	ETP617162	N/A	ETC618021-S3010	ETC618141	SID003112 (D1)
4018	30	ETP617172	N/A	ETC618021-S3010	ETC618141	SID000605 (D1)
4030	40/50	N/A	ETC617151	ETC618021-S3010	ETC618141	SID003112 (D1,D2)
4037	60	N/A	ETC617161	ETC618021-S3010	ETC618141	SID003112 (D1,D2)
4045	75	N/A	ETC617171	ETC618021-S3010	ETC618141	SID000605 (D1,D2)
4055	100	N/A	ETC617181	ETC618021-S3010	ETC618141	SID000605 (D1,D2)
4075	125	N/A	ETC617190	ETC618021-S3010	ETC618141	SID003117 (D1,D2)
4090	150	N/A	ETC617200	ETC618021-S3010	ETC618141	SID003117 (D1,D2)
4110	200	N/A	ETC617210	ETC618021-S3010	ETC618141	SID003109 (D1,D6)
4160	250	N/A	ETC617230	ETC618021-S3010	ETC618141	SID003119 (D1,D6)
4185	300/350	N/A	ETC617240	ETC618021-S3010	ETC618141	SID003119 (D1,D6)
4220	400/450	N/A	ETC617250	ETC618021-S3010	ETC618141	SID003131 (D1,D6)
4300	500+	N/A	ETC617260	ETC618021-S3010	ETC618141	SID003119(D1,D12)

Table F.2 480VAC Primary Parts (Continued)

Drive Model CIMR-P7U	Nominal Hp	Power Module	Transistor Module	DC Bus Fuse	Heat Sink Fan	Internal Fan
40P4	0.5/0.75	STR001298 (Q1)	Inside the Power Module	FU-002029 (F1)	N/A	N/A
40P7	1	STR001298 (Q1)	Inside the Power Module	FU-002029 (F1)	N/A	N/A
41P5	1.5/2	STR001298 (Q1)	Inside the Power Module	FU-002029 (F1)	N/A	N/A
42P2	3	STR001298 (Q1)	Inside the Power Module	FU-002029 (F1)	FAN001066 (B1)	N/A
43P7	5	STR001300 (Q1)	Inside the Power Module	FU-002031 (F1)	FAN001066 (B1)	N/A
45P5	7.5	STR001302 (Q1)	Inside the Power Module	FU-002031 (F1)	FAN001066 (B1)	N/A
47P5	10	STR001279 (Q1)	Inside the Power Module	FU-002032 (F1)	FAN001066 (B1,B2)	N/A
4011	10	N/A	STR001280 (Q1)	FU-002037 (F1)	FAN001066 (B1,B2)	FAN001043 (B3)
4015	15/20	N/A	STR001318 (Q1)	FU-002038 (F1)	FAN001065 (B1,B2)	N/A
4018	25	N/A	STR001318 (Q1)	FU-002038 (F1)	FAN001065 (B1,B2)	FAN001043 (B3)
4030	30	N/A	STR001324 (Q1)	FU-002039 (F1)	FAN001039 (B1,B2)	N/A
4037	60	N/A	STR001316 (Q1-Q3)	FU-002040 (F1)	FAN001044 (B1,B2)	N/A
4045	75	N/A	STR001317 (Q1-Q3)	FU-002040 (F1)	FAN001044 (B1,B2)	N/A
4055	100	N/A	STR001317 (Q1-Q3)	FU-002101 (F1)	FAN001044 (B1,B2)	N/A
4075	125	N/A	STR001294 (Q1-Q3)	FU-002112 (F1)	FAN001052 (B1,B2)	FAN001054 (B4)
4090	150	N/A	STR001336 (Q1-Q6)	FU-002113 (F1)	FAN001052 (B1,B2)	FAN001054 (B4)
4110	200	N/A	STR001336 (Q1-Q6)	FU-002114 (F1)	FAN001056 (B1,B2)	FAN001054 (B4)
4160	250	N/A	STR001322 (Q1-Q3)	FU-000895 (F1)	FAN001056 (B1,B2)	FAN001054 (B4)
4185	300/350	N/A	STR001339 (Q1-Q12)	FU-000895 (F1)	FAN001056 (B1,B4)	FAN001054 (B6,B7)
4220	400/450	N/A	STR001341 (Q1-Q12)	FU-002116 (F1)	FAN001056 (B1,B4)	FAN001054 (B6,B7)
4300	500+	N/A	STR001342 (Q1-Q12)	FU-002117 (F1)	FAN001082 (B1,B5)	FAN001054 (B6,B7)

Bypass Replacement Parts

Table F.3 Bypass Replacement Parts

INPUT VOLTS	Drive		NEC NOM. HP	P7 BYPASS BASE NO. P7B_XXXX	Motor Circuit Protector		Input Contactor		Output Contactor		Bypass Contactor		Overload Relay		Control Transformer		CPT Primary Fuses	
	MAIN P/N CIMR-				SQ. D PART NO.	YASK. PART NO.	YASK. P/N 5P32-	SQ. D P/N (K1) LC1-	YASK. P/N 5P32-	SQ. D P/N (K2) LC1-	YASK. P/N 5P32-	SQ. D PART (S10) NO.	YASK. P/N 5P37-	SQ. D P/N TF-	YASK. PART NO.	YASKAWA PART NO.	BUSSMANN PART NO.	
208	P7U22P2VA	0.5	D002	FAL3600712M	50188255	92	D0901F7	92	D0901F7	92	D0901F7	LR2-D1307	148	300D3	50210414	5P17-0359	FNQ-R-4	
	P7U22P2VA	0.75	D003	FAL3600712M	50188255	92	D0901F7	92	D0901F7	92	D0901F7	LR2-D1508	174	300D3	50210414	5P17-0359	FNQ-R-4	
	P7U22P2VA	1	D004	FAL3600712M	50188255	92	D0901F7	92	D0901F7	92	D0901F7	LR2-D1510	175	300D3	50210414	5P17-0359	FNQ-R-4	
	P7U22P2VA	1.5	N/A	FAL3601513M	50188256	95	D1801F7	95	D1801F7	95	D1801F7	LR2-D1512	176	300D3	50210414	5P17-0359	FNQ-R-4	
	P7U22P2VA	2	D007	FAL3601513M	50188256	95	D1801F7	95	D1801F7	95	D1801F7	LR2-D1512	176	300D3	50210414	5P17-0359	FNQ-R-4	
	P7U22P2VA	3	D010	FAL3601513M	50188256	95	D1801F7	95	D1801F7	95	D1801F7	LR2-D1516	178	300D3	50210414	5P17-0359	FNQ-R-4	
	P7U23P7VA	5	D016	FAL3603015M	50188250	95	D1801F7	95	D1801F7	95	D1801F7	LR2-D1521	179	300D3	50210414	5P17-0359	FNQ-R-4	
	P7U27P5VA	7.5	D024	FAL3605016M	50188251	96	D2501F7	96	D2501F7	96	D2501F7	LR2-D1522	180	300D3	50210414	5P17-0359	FNQ-R-4	
	P7U27P5VA	10	D030	FAL3605016M	50188251	97	D3201F7	97	D3201F7	97	D3201F7	LR2-D2553	181	300D3	50210414	5P17-0359	FNQ-R-4	
	P7U2011VA	15	D046	FAL3610018M	50188252	83	D5011F7	83	D5011F7	83	D5011F7	LR2-D3557	185	300D3	50210414	5P17-0359	FNQ-R-4	
	P7U2011VA	20	D059	FAL3610018M	50188252	84	D6511F7	84	D6511F7	84	D6511F7	LR2-D3559	186	300D3	50210414	5P17-0359	FNQ-R-4	
	P7U2018VA	25	D074	KAL3615026M	50188260	85	D8011F7	85	D8011F7	85	D8011F7	LR2-D3563	188	300D3	50210414	5P17-0359	FNQ-R-4	
	P7U20221A	30	D088	KAL3615026M	50188260	138	D11500F7	138	D11500F7	138	D11500F7	LR9-F5567	244	300D3	50210414	5P17-0359	FNQ-R-4	
	P7U20301A	40	D114	KAL3625032M	50188267	139	D15000F7	139	D15000F7	139	D15000F7	LR9-F5569	245	300D3	50210414	5P17-0359	FNQ-R-4	
	P7U20301A	40	D114	KAL3625032M	50188267	139	D15000F7	139	D15000F7	139	D15000F7	LR9-F5569	245	500D3	50210416	5P17-0360	FNQ-R-5	
	P7U20370A	50	D143	KAL3625032M	50188267	139	D15000F7	139	D15000F7	110	F185G6	LR9-F5569	245	500D3	50210416	5P17-0360	FNQ-R-5	
	P7U20450A	60	D169	FAL3625032M	50188267	139	D15000F7	139	D15000F7	111	F265F7	LR9-F5571	246	500D3	50210416	5P17-0360	FNQ-R-4	
P7U20550A	75	D211	LAL3640036M	50188275	111	F265F7	111	F265F7	112	F330F7	LR9-F7575	247	500D3	50210416	5P17-0360	FNQ-R-5		
P7U20750A	100	D273	LAL3640036M	50188275	112	F330F7	111	F265F7	113	F400F7	LR9-F7575	247	500D3	50210416	5P17-0360	FNQ-R-5		
P7U20900A	125	D343	MAL3660036M	UCB000061	113	F400F7	112	F330F7	114	F500F7	LR9-F7579	248	750D3	50210417	5P17-0361	FNQ-R-7 1/2		
P7U21100A	150	D396	MAL3660036M	UCB000061	114	F500F7	113	F400F7	114	F500F7	LR9-F7579	248	750D3	50210417	5P17-0361	FNQ-R-7 1/2		
240	P7U22P2VA	0.5	A002	FAL3600311M	50188254	92	D0901F7	92	D0901F7	92	D0901F7	LR2-D1307	148	300D1	5P58-1010	5P617-0391	FNQ-R-3 1/2	
	P7U22P2VA	0.75	A003	FAL3600712M	50188255	92	D0901F7	92	D0901F7	92	D0901F7	LR2-D1508	174	300D1	5P58-1010	5P617-0391	FNQ-R-3 1/2	
	P7U22P2VA	1	A004	FAL3600712M	50188255	92	D0901F7	92	D0901F7	92	D0901F7	LR2-D1508	174	300D1	5P58-1010	5P617-0391	FNQ-R-3 1/2	
	P7U22P2VA	1.5	N/A	FAL3601513M	50188256	95	D1801F7	95	D1801F7	95	D1801F7	LR2-D1512	176	300D1	5P58-1010	5P617-0391	FNQ-R-3 1/2	
	P7U22P2VA	2	A006	FAL3601513M	50188256	95	D1801F7	95	D1801F7	95	D1801F7	LR2-D1512	176	300D1	5P58-1010	5P617-0391	FNQ-R-3 1/2	
	P7U22P2VA	3	A009	FAL3601513M	50188256	95	D1801F7	95	D1801F7	95	D1801F7	LR2-D1514	177	300D1	5P58-1010	5P617-0391	FNQ-R-3 1/2	
	P7U23P7VA	5	A015	FAL3603015M	50188250	95	D1801F7	95	D1801F7	95	D1801F7	LR2-D1521	179	300D1	5P58-1010	5P617-0391	FNQ-R-3 1/2	
	P7U25P5VA	7.5	A022	FAL3605016M	50188251	96	D2501F7	96	D2501F7	96	D2501F7	LR2-D1522	180	300D1	5P58-1010	5P617-0391	FNQ-R-3 1/2	
	P7U27P5VA	10	A028	FAL3605016M	50188251	97	D3201F7	97	D3201F7	97	D3201F7	LR2-D2553	181	300D1	5P58-1010	5P617-0391	FNQ-R-3 1/2	
	P7U2011VA	15	A042	FAL3610018M	50188252	83	D5011F7	83	D5011F7	83	D5011F7	LR2-D3557	185	300D1	5P58-1010	5P617-0391	FNQ-R-3 1/2	
	P7U2018VA	20	A054	FAL3610018M	50188252	84	D6511F7	84	D6511F7	84	D6511F7	LR2-D3559	186	300D1	5P58-1010	5P617-0391	FNQ-R-3 1/2	
	P7U2018VA	25	A068	FAL3610018M	50188252	85	D8011F7	85	D8011F7	85	D8011F7	LR2-D3561	187	300D1	5P58-1010	5P617-0391	FNQ-R-3 1/2	
	P7U20221A	30	A080	KAL3615026M	50188260	85	D8011F7	85	D8011F7	85	D8011F7	LR2-D3563	188	300D1	5P58-1010	5P617-0391	FNQ-R-3 1/2	
	P7U20301A	40	A104	KAL3615026M	50188260	138	D11500F7	138	D11500F7	138	D11500F7	LR9-F5569	245	300D1	5P58-1010	5P617-0391	FNQ-R-3 1/2	
	P7U20370A	50	A130	KAL3625032M	50188267	139	D15000F7	139	D15000F7	139	D15000F7	LR9-F5569	245	500D1	50210407	5P17-0360	FNQ-R-5	
	P7U20370A	60	A154	KAL3625032M	50188267	139	D15000F7	139	D15000F7	110	F185G6	LR9-F5571	246	500D1	50210407	5P17-0360	FNQ-R-5	
	P7U20450A	75	A192	KAL3625032M	50188267	111	F265F7	111	F265F7	111	F265F7	LR9-F5571	246	500D1	50210407	5P17-0360	FNQ-R-5	
P7U20750A	100	A248	LAL3640036M	50188275	111	F265F7	111	F265F7	112	F330F7	LR9-F7575	247	500D1	50210407	5P17-0360	FNQ-R-5		
P7U20750A	125	A312	MAL3660036M	UCB000061	112	F330F7	112	F330F7	113	F400F7	LR9-F7579	248	500D1	50210407	5P17-0360	FNQ-R-5		
P7U20900A	150	A360	MAL3660036M	UCB000061	113	F400F7	112	F330F7	114	F500F7	LR9-F7579	248	750D1	50210405	5P17-0361	FNQ-R-7 1/2		
480	P7U42P2VA	0.5	B001	FAL3600311M	50188254	92	D0901F7	92	D0901F7	92	D0901F7	LR2-D1306	146	300D1	5P58-1010	5P17-0356	FNQ-R-1 1/2	
	P7U42P2VA	0.75	B001	FAL3600311M	50188254	92	D0901F7	92	D0901F7	92	D0901F7	LR2-D13X6	146	300D1	5P58-1010	5P17-0356	FNQ-R-1 1/2	
	P7U42P2VA	1	B002	FAL3600712M	50188255	92	D0901F7	92	D0901F7	92	D0901F7	LR2-D1307	148	300D1	5P58-1010	5P17-0356	FNQ-R-1 1/2	
	P7U42P2VA	1.5	N/A	FAL3600712M	50188255	92	D0901F7	92	D0901F7	92	D0901F7	LR2-D1508	174	300D1	5P58-1010	5P17-0356	FNQ-R-1 1/2	
	P7U42P2VA	2	B003	FAL3600712M	50188255	92	D0901F7	92	D0901F7	92	D0901F7	LR2-D1508	174	300D1	5P58-1010	5P17-0356	FNQ-R-1 1/2	
	P7U42P2VA	3	B004	FAL3600712M	50188255	92	D0901F7	92	D0901F7	92	D0901F7	LR2-D1510	175	300D1	5P58-1010	5P17-0356	FNQ-R-1 1/2	
	P7U43P7VA	5	B007	FAL3601513M	50188256	95	D1801F7	95	D1801F7	95	D1801F7	LR2-D1512	176	300D1	5P58-1010	5P17-0356	FNQ-R-1 1/2	
	P7U45P5VA	7.5	B011	FAL3601513M	50188256	95	D1801F7	95	D1801F7	95	D1801F7	LR2-D1516	178	300D1	5P58-1010	5P17-0356	FNQ-R-1 1/2	
	P7U47P5VA	10	B014	FAL3603015M	50188250	95	D1801F7	95	D1801F7	95	D1801F7	LR2-D1521	179	300D1	5P58-1010	5P17-0356	FNQ-R-1 1/2	
	P7U4011VA	15	B021	FAL3605016M	50188251	96	D2501F7	96	D2501F7	96	D2501F7	LR2-D1522	180	300D1	5P58-1010	5P17-0356	FNQ-R-1 1/2	
	P7U4011VA	20	B027	FAL3605016M	50188251	97	D3201F7	97	D3201F7	97	D3201F7	LR2-D2553	181	300D1	5P58-1010	5P17-0356	FNQ-R-1 1/2	
	P7U4015VA	25	B034	FAL3605016M	50188251	93	D4011F7	93	D4011F7	93	D4011F7	LR2-D3555	184	300D1	5P58-1010	5P17-0356	FNQ-R-1 1/2	
	P7U4018VA	30	B040	FAL3610018M	50188252	93	D4011F7	93	D4011F7	93	D4011F7	LR2-D3555	184	300D1	5P58-1010	5P17-0356	FNQ-R-1 1/2	
	P7U4030QA	40	B052	FAL3610018M	50188252	83	D5011F7	83	D5011F7	83	D5011F7	LR2-D3559	186	300D1	5P58-1010	5P17-0356	FNQ-R-1 1/2	
	P7U4030QA	50	B065	FAL3610018M	50188252	84	D6511F7	84	D6511F7	84	D6511F7	LR2-D3561	187	300D1	5P58-1010	5P17-0356	FNQ-R-1 1/2	
	P7U4037QA	60	B077	FAL3610018M	50188252	85	D8011F7	85	D8011F7	85	D8011F7	LR2-D3563	188	300D1	5P58-1010	5P17-0356	FNQ-R-1 1/2	
	P7U4045QA	75	B096	KAL3615026M	50188260	138	D11500F7	138	D11500F7	138	D11500F7	LR9-F5567	244	300D1	5P58-1010	5P17-0356	FNQ-R-1 1/2	
	P7U4055QA	100	B124	KAL3625032M	50188267	139	D15000F7	139	D15000F7	139	D15000F7	LR9-F5569	245	300D1	5P58-1010	5P17-0356	FNQ-R-1 1/2	
	P7U4055QA	100	B124	KAL3625032M	50188267	139	D15000F7	139	D15000F7	139	D15000F7	LR9-F5569	245	500D1	50210407	5P17-0357	FNQ-R-2 1/2	
	P7U4075QA	125	B156	KAL3625032M	50188267	139	D15000F7	139	D15000F7	110	F185G6	LR9-F5571	246	500D1	50210407	5P17-0357	FNQ-R-2 1/2	
P7U40900A	150	B180	KAL3625032M	50188267	139	D15000F7	139	D15000F7	111	F265F7	LR9-F5571	246	500D1	50210407	5P17-0357	FNQ-R-2 1/2		
P7U41100A	200	B240	LAL3640036M	50188275	111	F265F7	111	F265F7	112	F330F7	LR9-F7575	247	500D1	50210407	5P17-0357	FNQ-R-2 1/2		
P7U41600A	250	B302	LAL3640036M	50188275	112	F330F7	112	F330F7	113	F400F7	LR9-F7579	248	500D1	50210407	5P17-035			

Table F.3 Bypass Replacement Parts

CPT Secondary Fuses		Drive Input Fuses - Option F						DC Bus Choke				3% Reactor-Option R		5% Reactor-Option K		RFI Filter - Option E	
		Semiconductor Fuses F3, F4, F5 (QTY. 3)			Fuse Block F3, F4, F5			3% - Option X		5% - Option Z		YASKAWA PART NUMBER	MTE PART NUMBER	YASKAWA PART NUMBER	MTE PART NUMBER	NEW SAP PART NO.	MTE/SCHAFFNER PART NUMBER
		YASKAWA PART NO.	BUSSMANN PART NO.	YASKAWA PART NO.	BUSSMANN PART NO.	YASKAWA PART NO.	BUSSMANN PART NO.	QTY.	RECD.	YASKAWA PART NO.	MTE P/N						
N/A	N/A	UFU000025	FWH-5A14F	UFU000062		70308	1	URX000041	4RB002	5P620-0109	4RB003	5P620-0017	RL-00401	URX000080	UF1000035	RF3-0010-4	
N/A	N/A	5P17-0422	FWH-10A14F	UFU000062		70308	1	5P620-0111	9RB003	URX000041	4RB002	5P620-0017	RL-00401	5P620-0132	UF1000035	RF3-0010-4	
N/A	N/A	5P17-0422	FWH-10A14F	UFU000062		70308	1	URX000046	12RB004	5P620-0111	9RB003	5P620-0024	RL-00801	5P620-0017	UF1000035	RF3-0010-4	
N/A	N/A	UFU000028	FWH-15A14F	UFU000062		70308	1	5P652-0213	12RB003	URX000046	12RB004	5P620-0024	RL-00801	5P620-0133	UF1000035	RF3-0010-4	
N/A	N/A	UFU000028	FWH-15A14F	UFU000062		70308	1	URX000048	18RB003	5P652-0213	12RB003	5P620-0024	RL-00801	5P620-0133	UF1000035	RF3-0010-4	
N/A	N/A	UFU000029	FWH-25A14F	UFU000062		70308	1	URX000052	25RB003	5P652-0213	12RB003	5P620-0136	RL-01801	5P620-0134	UF1000036	RF3-0010-4	
N/A	N/A	UFU000032	FWH-40B	5P19-0104	1BS101		3	URX000053	25RB004	URX000052	25RB003	URX000083	RL-02501	5P620-0136	UF1000036	RF3-0010-4	
N/A	N/A	5P617-0385	FWH-50B	5P19-0104	1BS101		3	5P620-0120	32RB001	URX000055	32RB002	URX000083	RL-02501	5P620-0139	UF1000037	RF3-0025-4	
N/A	N/A	5P17-0363	FWH-70B	5P19-0104	1BS101		3	URX000059	50RB001	5P620-0044	50RB003	5P620-0049	RL-03501	5P620-0049	UF1000039	RF3-0050-4	
N/A	N/A	5P17-0260	FWH-100B	5P19-0104	1BS101		3	URX000059	50RB001	URX000059	50RB001	5P620-0141	RL-05501	5P620-0142	UF1000039	RF3-0050-4	
N/A	N/A	5P17-0261	FWH-125B	5P19-0105	1BS102		3	URX000068	80RB002	URX000073	92RB002	5P620-0143	RL-08001	5P620-0144	UF1000041	RF3-0090-4	
N/A	N/A	UFU000035	FWH-175B	5P19-0105	1BS102		3					URX000085	RL-10001	5P620-0143	UF1000041	RF3-0090-4	
N/A	N/A	5P17-0245	FWH-200B	5P19-0105	1BS102		3					URX000085	RL-10001	5P620-0013	UF1000042	RF3-0130-4	
N/A	N/A	UFU000052	FWX-225A	5P19-0106	1BS103		3					5P620-0064	RL-13001	5P620-0013	UF1000042	RF3-0130-4	
5P617-0392	FNQ-R-7	UFU000052	FWX-225A	5P19-0106	1BS103		3					5P620-0064	RL-13001	5P620-0013	UF1000042	RF3-0130-4	
5P617-0392	FNQ-R-7	UFU000055	FWX-300A	5P19-0106	1BS103		3					5P620-0069	RL-16001	5P620-0070	UF1000043	RF3-0150-4	
5P617-0392	FNQ-R-7	UFU000055	FWX-300A	5P19-0106	1BS103		3					5P620-0075	RL-20001	5P620-0146	UF1000044	RF3-0330-4	
5P617-0392	FNQ-R-7	UFU000057	FWX-400A	5P19-0106	1BS103		3					5P620-0080	RL-25001	5P620-0147	UF1000044	RF3-0330-4	
5P617-0392	FNQ-R-7	UFU000044	FWH-500A	UFU000063	1BS104		3					5P620-0085	RL-32001	5P620-0148	UF1000044	RF3-0330-4	
5P617-0392	FNQ-R-7	UFU000061	FWX-700A	UFU000065	BH3145		3					URX000087	RL-40001	5P620-0090	UF1000032	FS5972-600-99	
5P617-0392	FNQ-R-7	UFU000061	FWX-700A	UFU000065	BH3145		3					URX000088	RL-50001	5P620-0094	UF1000032	FS5972-600-99	
N/A	N/A	UFU000025	FWH-5A14F	UFU000062		70308	1	URX000041	4RB002	5P620-0109	4RB003	URX000080	RL-00204	5P620-0131	UF1000035	RF3-0010-4	
N/A	N/A	5P17-0422	FWH-10A14F	UFU000062		70308	1	5P620-0111	9RB003	URX000041	4RB002	5P620-0017	RL-00401	5P620-0132	UF1000035	RF3-0010-4	
N/A	N/A	5P17-0422	FWH-10A14F	UFU000062		70308	1	5P620-0111	9RB003	URX000044	9RB004	5P620-0017	RL-00401	5P620-0132	UF1000035	RF3-0010-4	
N/A	N/A	UFU000028	FWH-15A14F	UFU000062		70308	1	5P652-0213	12RB003	5P620-0111	9RB003	5P620-0024	RL-00801	5P620-0133	UF1000035	RF3-0010-4	
N/A	N/A	UFU000028	FWH-15A14F	UFU000062		70308	1	5P652-0213	12RB003	URX000046	12RB004	5P620-0024	RL-00801	5P620-0133	UF1000035	RF3-0010-4	
N/A	N/A	5P17-0338	FWH-20A14F	UFU000062		70308	1	URX000048	18RB003	5P652-0213	12RB003	5P620-0134	RL-01201	5P620-0135	UF1000035	RF3-0010-4	
N/A	N/A	UFU000031	FWH-35B	5P19-0104	1BS101		3	URX000052	25RB003	URX000048	18RB003	5P620-0136	RL-01801	5P620-0137	UF1000036	RF3-0010-4	
N/A	N/A	UFU000032	FWH-40B	5P19-0104	1BS101		3	URX000053	25RB004	URX000052	25RB003	URX000083	RL-02501	5P620-0138	UF1000037	RF3-0025-4	
N/A	N/A	5P17-0288	FWH-60B	5P19-0104	1BS101		3	5P620-0120	32RB001	URX000055	32RB002	5P620-0044	RL-03501	5P620-0139	UF1000039	RF3-0050-4	
N/A	N/A	UFU000034	FWH-90B	5P19-0104	1BS101		3	URX000059	50RB001	URX000060	50RB002	5P620-0140	RL-04501	5P620-0142	UF1000039	RF3-0050-4	
N/A	N/A	5P17-0261	FWH-125B	5P19-0105	1BS102		3	URX000068	80RB002	URX000070	80RB004	5P620-0141	RL-05501	5P620-0142	UF1000041	RF3-0090-4	
N/A	N/A	5P17-0279	FWH-150B	5P19-0105	1BS102		3	URX000068	80RB002	URX000073	92RB002	5P620-0143	RL-08001	5P620-0144	UF1000041	RF3-0090-4	
N/A	N/A	UFU000035	FWH-175B	5P19-0105	1BS102		3					URX000085	RL-10001	5P620-0143	UF1000041	RF3-0090-4	
N/A	N/A	5P17-0245	FWH-200B	5P19-0105	1BS102		3					5P620-0064	RL-13001	5P620-0013	UF1000042	RF3-0130-4	
5P617-0392	FNQ-R-7	UFU000036	FWH-250A	5P19-0106	1BS103		3					5P620-0064	RL-13001	5P620-0013	UF1000043	RF3-0150-4	
5P617-0392	FNQ-R-7	UFU000055	FWX-300A	5P19-0106	1BS103		3					5P620-0069	RL-16001	5P620-0070	UF1000044	RF3-0330-4	
5P617-0392	FNQ-R-7	UFU000057	FWX-400A	5P19-0106	1BS103		3					5P620-0075	RL-20001	5P620-0146	UF1000044	RF3-0330-4	
5P617-0392	FNQ-R-7	UFU000044	FWH-500A	UFU000063	1BS104		3					5P620-0080	RL-25001	5P620-0147	UF1000044	RF3-0330-4	
5P617-0392	FNQ-R-7	5P17-0265	FWH-600A	UFU000063	1BS104		3					5P620-0085	RL-32001	5P620-0148	UF1000032	FS5972-600-99	
5P617-0392	FNQ-R-7	UFU000061	FWX-700A	UFU000065	BH3145		3					URX000087	RL-40001	5P620-0090	UF1000032	FS5972-600-99	
N/A	N/A	UFU000023	FWH-3A14F	UFU000062		70308	1	URX000039	2RB004	URX000039	2RB004	URX000078	RL-00104	URX000077	UF1000035	RF3-0010-4	
N/A	N/A	UFU000024	FWH-4A14F	UFU000062		70308	1	URX000039	2RB004	URX000039	2RB004	5P620-0131	RL-00201	5P620-0014	UF1000035	RF3-0010-4	
N/A	N/A	UFU000025	FWH-5A14F	UFU000062		70308	1	URX000042	4RB004	URX000039	2RB004	5P620-0131	RL-00201	5P620-0014	UF1000035	RF3-0010-4	
N/A	N/A	UFU000026	FWH-6A14F	UFU000062		70308	1	5P620-0109	4RB003	URX000042	4RB004	5P620-0132	RL-00402	URX000081	UF1000035	RF3-0010-4	
N/A	N/A	5P17-0422	FWH-10A14F	UFU000062		70308	1	5P620-0109	4RB003	URX000042	4RB004	5P620-0132	RL-00402	URX000081	UF1000035	RF3-0010-4	
N/A	N/A	UFU000027	FWH-12A14F	UFU000062		70308	1	URX000044	9RB004	URX000044	9RB004	5P620-0025	RL-00803	5P620-0018	UF1000035	RF3-0010-4	
N/A	N/A	5P17-0338	FWH-20A14F	UFU000062		70308	1	URX000046	12RB004	URX000044	9RB004	5P620-0133	RL-00802	5P620-0025	UF1000035	RF3-0010-4	
N/A	N/A	UFU000029	FWH-25A14F	UFU000062		70308	1	5P652-0213	12RB003	URX000046	12RB004	5P620-0135	RL-01202	5P620-0031	UF1000036	RF3-0010-4	
N/A	N/A	UFU000030	FWH-30A14F	UFU000062		70308	1	5P652-0216	18RB004	URX000049	18RB005	5P620-0137	RL-01802	5P620-0035	UF1000036	RF3-0010-4	
N/A	N/A	5P617-0385	FWH-50B	5P19-0104	1BS101		3	URX000056	32RB003	URX000054	25RB005	5P620-0138	RL-02502	5P620-0040	UF1000037	RF3-0025-4	
N/A	N/A	5P17-0363	FWH-70B	5P19-0104	1BS101		3	URX000055	32RB002	URX000056	32RB003	5P620-0139	RL-03502	5P620-0045	UF1000039	RF3-0050-4	
N/A	N/A	5P617-0347	FWH-80B	5P19-0104	1BS101		3	URX000061	50RB003	URX000061	50RB003	5P620-0139	RL-03502	5P620-0045	UF1000039	RF3-0050-4	
N/A	N/A	5P17-0260	FWH-100B	5P19-0104	1BS101		3	URX000061	50RB003	URX000061	50RB003	5P620-0049	RL-04502	5P620-0012	UF1000039	RF3-0050-4	
N/A	N/A	5P17-0260	FWH-100B	5P19-0104	1BS101		3					5P620-0142	RL-05502	URX000084	UF1000041	RF3-0090-4	
N/A	N/A	5P17-0261	FWH-125B	5P19-0105	1BS102		3					5P620-0144	RL-08002	5P620-0057	UF1000041	RF3-0090-4	
N/A	N/A	5P17-0279	FWH-150B	5P19-0105	1BS102		3					5P620-0145	RL-10002	5P620-0061	UF1000041	RF3-0090-4	
N/A	N/A	5P17-0245	FWH-200B	5P19-0105	1BS102		3					5P620-0145	RL-10002	5P620-0061	UF1000042	RF3-0130-4	
N/A	N/A	5P617-0348	FWH-225A	5P19-0106	1BS103		3					5P					

Table F.4 Bypass Common Replacement Parts	
Part Description	Part Number
W1 AND W2 CABINET FAN	UFN000005
W1 AIR FILTER	UFL00001-1
W2 AIR FILTER	UFL00001-2
F1 CABINET FAN	5P16-0012
F1 FILTER	UFL00001-3
DIGITAL OPERATOR	CDR001115
OPERATOR INTERGFACE PCB A3	UTC000037-2
22mm, selector SW, 2 pos., maintained	USW000071
22mm, selector SW, 3 pos., maintained	USW000072
22mm, pilot light head for LED, WHITE	USD000038
22mm, pilot light head for LED, GREEN	USD000039
22mm, pilot light head for LED, RED	USD000037
22mm, pilot light head for LED, AMBER	USD000040
22mm, pilot light head for LED, BLUE	USD000041
22mm, Body/Collar	UBM-0006
22mm, PCB contact block 1 N.O., standard	UMC000080
22mm, PCB light module, LED, 24V, WHITE	USD000043
22mm, PCB light module, LED, 24V, GREEN	USD000044
22mm, PCB light module, LED, 24V, RED	USD000042
Relay controller PCB A2	UTC000036
Cabinet door operator panel	UOPN0001

W1 = Wall mount enclosure 1
W2 = Wall mount enclosure 2
F1 = Floor mount enclosure 1

A

A. TUNE.....	3-7, 3-14
AC Reactor	E-4
Accel/Decel	
Parameters	A-7
Switch Frequency	5-19, A-7
Time	5-19
Acceleration	
Stall Prevention Level during	6-16, A-20
Time.....	5-19, A-7
Troubleshooting.....	6-5, 6-10, 6-12, 6-16
Access Level	A-2
ADV	3-7, 3-13
Alarm Displays & Processing.....	6-8
ALARM Indicator	3-4
Altitude	C-4
Ambient Temperature – See Temperature	
Analog Inputs	
Bias.....	5-26, A-16
Connection Diagram.....	2-16
Control Circuit Terminals.....	2-13
Gain	5-26, A-15
Parameters	A-16
Troubleshooting.....	6-15
Analog Outputs	
Bias	A-17, A-18
Connection Diagram.....	2-16
Control Circuit Terminals.....	2-13
Gain	A-17
Parameters	A-17, A-18
APOGEE FLN.....	iii, iv, A-18, D-1
ASIC Faults	6-3
AUTO	
Key	3-3
Mode.....	3-3
REF Indicator	3-4, 3-5
SEQ Indicator	3-4, 3-5
Auto Restart.....	5-31
Count Reset	5-31
Faults Covered.....	5-31
Max. Restart Time After Fault	5-31
Number of Attempts.....	5-31
Auto-Tuning	
Fault Displays and Processing.....	6-12
How to	5-39
Line-to-Line Resistance	5-39, A-11
Menu.....	3-7, 3-14
Motor Rated Current	A-25
Motor Rated Power	A-25

B

Base Block	
After Fault.....	5-31
Circuit Fault	6-2
Minimum Time	5-6
Basic Programming.....	5-1 to 5-40
Baud Rate	6-8, D-2, D-4
Bias Adjustments	5-26, 5-27, A-16, A-18
Braking	
DC Injection – See DC Injection Braking	
High-Slip.....	A-23
Branch Short Circuit Protection.....	E-2, E-3

C

Cable Length.....	2-11
Capacitors – See DC Bus Capacitors	
Capacity, Rated Output	C-2, C-3
Capacity Related Parameters	B-1
Carrier Frequency	
Error	6-11
Lower Limit	A-8
Parameters.....	A-8
Proportional Gain	A-8
Selection	A-8
Upper limit	A-8
Vs. Cable Length	2-11
Characteristic Frequency – See Oscillation	
Charge Indicator (LED)	i, 1-6, 2-2, 4-5, C-4
Circuit Breakers	2-9, E-2, E-3
Clearances – See Installation, Physical	
Coast to Stop	5-5
Coast w/Timer.....	5-6
Com OPT Setup Parameters.....	A-11
Communications – Also see Modbus Communications and Serial Communications	
Errors (CPF).....	6-2 to 6-4, 6-8
Parameters.....	A-18
Component Names.....	1-5, 1-6
Connections	
Preventive Maintenance.....	7-3
Connectors	
Inspection.....	7-2
Sizing	2-3 to 2-7
Contactors	
Magnetic	E-4
Soft Charge – See Soft Charge Contactor	
Control	
Characteristics.....	C-4

Circuit		DC Injection Braking	
Connection Diagram.....	2-16	Current.....	5-6
Terminal Configuration	2-12	Parameters	A-4
Method.....	C-4	Start Frequency.....	5-5
PCB		Time at Start	A-4
Inspecting	7-2	Time at Stop.....	5-6
Spare Parts.....	F-2, F-3	DC Reactor (See also Specifications).....	2-8, E-4
Power Fuse	6-22	DCInj to Stop.....	5-6
Terminal Functions	2-13	DDLY Waiting to RUN – See Drive Delay	
Wiring	2-12	Deadband, Prohibited Frequency – See Jump Frequency and	
Precautions	2-17	Frequency Limits	
Cooling		Deceleration	
Fan – See Fan		Coast to Stop	5-5
Fins		Coast w/ Timer	5-6
Inspecting	7-2	DCInj to Stop.....	5-6
Preventive Maintenance	7-3	Indicators	3-6
COPY Function.....	5-37, 5-38	Ramp to Stop.....	5-5
Faults	6-13	Stall Prevention during.....	A-20
Read Allowed Selection	5-37, 6-13, A-25	Time	5-19, A-7
Selection	5-37, A-25	Troubleshooting.....	6-6, 6-9
Covers		DECREASE Key.....	3-3
Protective.....	1-5 to 1-7, 1-11	Troubleshooting.....	6-14
Removing and Attaching.....	1-13, 1-14	Delay Timer Parameters	A-5
CPU Faults.....	6-3	Diagnostics — See Troubleshooting	
Critical Frequency Rejection – See Jump Frequency		Digital Inputs	
Current		Connection Diagram.....	2-16
DC Injection Braking	5-6	Control Circuit Terminals.....	2-13
Maximum Output	C-4	Parameters	A-12
Monitor	2-13, A-11	Sinking/Sourcing Terminals	2-13, 2-15, 2-16
Motor Rated (FLA).....	4-7, 5-26, 6-12, A-11	Troubleshooting.....	6-14, 6-15
Rated Output	C-2, C-3	Digital "Motor Operated Pot" – See MOP	
D		Digital Operator	3-1
DATA/ENTER Key	3-3	Data Display.....	3-2
Data Length – See Modbus Communications		Display Selection (Display Scaling)	A-23
Date Stamp Information.....	6-24	Drive Operation when Disconnected	A-24
DC Braking – See DC Injection Braking		Faults/Errors	6-2, 6-6, 6-14
DC Bus Capacitors		Keys.....	3-3
Inspecting.....	7-2	LCD Brightness Adjustment	A-24
Preventive Maintenance	7-3	Lights – See Indicators	
DC Bus Fuse		Mode Indicators.....	3-4
Checking.....	6-21	Mode Selection	3-3
Fault	6-6	Monitor Selection (At Power-up) – See Monitor	
Spare Parts.....	F-2, F-3	Preventive Maintenance	7-3
DC Bus Voltage		Removing and Attaching.....	1-14 to 1-16
Checking.....	6-20	Write-protected – See COPY Function, Read Allowed	
Overvoltage	6-6, 6-9, C-4	Digital Outputs	
Safety.....	i	Connection Diagram.....	2-16
Undervoltage	5-26 to 5-30, 6-7, 6-10, C-4	Control Circuit Terminals.....	2-13
		Parameters	A-15
		"Restart Enable"	5-31

Dimensions	1-7 to 1-10
Diodes, Input – See Input Diodes	
Diode Module	
Resistance Test	6-20, 6-21
Spare Parts.....	F-2, F-3
DIP Switch S1	2-14
Displaying Faults – See Fault History, Fault Trace	
“Down Arrow” Key – See DECREASE Key	
DRIVE – See Operation Menu	
Drive Delay Time	5-7, A-4
Drive Mode, Troubleshooting	6-15
DriveWizard Software.....	iv, 5-39

E

EEPROM	
Enter Command.....	D-11
Fault/Error	6-2, 6-11, 6-13
Maximum Number of Writes	D-11
Elapsed Timer Function	5-37
Monitor.....	5-37, A-27
Parameters	A-24, A-25
EMC	
Compatibility.....	2-19
Filters.....	2-20
Enclosed wall-mounted type	1-2 to 1-4, C-4
Enclosure Style	1-2 to 1-4, C-4
Energy Saving	
Parameters	A-7
Selection	5-19, A-7
Environment – See Installation Site	
ESC Key	3-3
External Faults (EF)	6-4, 6-8
External Fault Inputs	2-13, 6-4

F

Factory Repair	Inside Back Cover
Fan	
Checking	6-23
Cumulative Operation Time Setting	A-25
Fuse, Checking.....	6-23
Heatsink Cooling Fan	
Operation Delay Time.....	5-34, A-22
Operation Selection.....	A-22
Replacement Method.....	7-5, 7-6
Spare Parts.....	F-2, F-3
Inspecting.....	7-2, 7-3
Internal, Spare Parts	F-2, F-3
Troubleshooting.....	6-19

Fast-Stop Time	A-7
Faults	
Clearing	A-25
Covered by Auto Restart	5-30
Digital Output Signal.....	2-13
Effect on Drive Operation	5-31
History	3-9 to 3-11, A-29
Listing of.....	6-2
Reset	3-3
Trace	3-9 to 3-11, A-28
Feedback (PI Function).....	5-15
Differential.....	5-9
Loss Detection Level	5-15, A-6
Loss Detection Time.....	5-15, A-6
Reference Missing Detection Selection.....	5-15, A-5
Square Root Function Activation	5-19, A-6
Field Service	Inside Back Cover
FLA, Motor	4-6, 5-25, 6-12, A-11
Flash ID	A-27
Forward Run/Stop Command	2-13, 2-16
Programming	5-3, 5-4, A-4
Frequency Detection Multi-function Output – See Digital Outputs	
Frequency, Output	
Accuracy	C-4
Allowable Fluctuation – See Specifications	
Carrier – See Carrier Frequency	
Command Selection – See Speed Command	
Jump	6-19, A-9
Lower Limit.....	5-19, 5-20, A-9
Max. Output	5-19, 5-20, A-10
(Also see Specifications)	
Meter (Analog Monitor) – See Analog Outputs	
Mid Output	A-10
Minimum Output	6-15, A-10
Monitor (U1-02)	A-26
Prohibited – See Jump Frequency and Frequency Limits	
Rated – See Specifications	
Setting Resolution.....	C-4
Setting Signal.....	C-4
Troubleshooting.....	6-19
Upper Limit	5-19, 6-19, A-9
Frequency Reference	
Analog Input	2-13, 2-16, A-4, A-15
At Loss of Frequency Reference	5-30
Bias	5-26 to 5-29, A-16
Drift	5-16
Gain	5-26 to 5-29, A-16
Jog	2-13, 2-16, A-8
Loss Detection	5-30

Setting Method Selection (MOP).....	5-36, A-24
Source (b1-01).....	2-12, 2-13, 2-16, 3-3, 3-5, A-4
Frequency References 1 thru 4 – See Preset Speeds	
Full Load Amps (FLA)	4-7, 5-26, 6-12, A-11
Fuse Blown Protection	C-4
FWD Indicator.....	3-4

G

Gain Adjustments	5-26, 5-27, A-16
Gate Drive PCBs	
Inspecting	7-2
Spare Parts.....	F-2, F-3
Ground Fault (GF).....	5-31, 6-5
Ground Fault Interrupter (GFI)	E-4
Troubleshooting	6-18
Grounding	2-11
Protection	C-4
Shield Wire.....	2-13

H

HAND	
Frequency Reference Selection.....	3-4, A-4
Indicators.....	3-4, 3-5
Key	3-4
Function Selection	A-25
Mode	3-4
Troubleshooting	6-15
Hardware Protection Parameters	A-22
Harmonics, Power Supply	C-2, C-3
Heatsink – See Cooling Fins	
Heatsink Fan – See Fan, Heatsink Cooling	
High-Slip Braking	A-23
H/O/A (Hand/Off/Auto) – See Digital Operator	
Horsepower, converting to kW.....	5-39
Humidity.....	1-11
Ambient Operating.....	C-4
Hunting Prevention	
Parameters	A-23
Troubleshooting	6-18

I

IEC IP00 – See Open Chassis	
IEC IP20 – See Enclosed wall-mounted type	
IGBT (Transistor Module)	
Inspecting	7-2
Resistance Test	6-20 to 6-22
Spare Parts.....	F-2, F-3

INCREASE Key	3-3
Troubleshooting.....	6-14
Indicators, Mode	3-4 to 3-6
Initial Start-up	4-1 to 4-10
Initialization	
Mode Selection	5-2, 5-36
Parameters	A-2
Specification Selection	5-2, A-25
Input	
Diodes, Inspecting	7-2
Fuses	2-9, E-2, E-3
Multi-function Terminals – See Analog Inputs and Digital Inputs	
Phase Loss Detection Level.....	6-6, A-22
Terminal Status (U1-10)	A-26
Voltage	A-10, C-2, C-3
Setting.....	4-5, 5-15, A-10

Inputs

Analog – See Analog Inputs	
Digital – See Digital Inputs	
Frequency Reference – See Frequency Reference	

Inspection

Periodic	7-2
Receiving	1-3

Installation

Electrical	2-1
Physical	1-1
Adverse Conditions	7-3
Orientation & Clearances	1-12
Site.....	1-11, C-4

Integral Limit (PI).....

.....	5-13
-------	------

Interference

.....	2-19 to 2-21
-------	--------------

IPM (Intelligent Power Module)

Inspecting.....	7-2
Spare Parts	F-2, F-3

J

Jog Frequency Reference

.....	2-13, 2-16, A-8
-------	-----------------

Jump Frequency.....

.....	A-9
Troubleshooting.....	6-19

K

Keypad — See Digital Operator

kVA	
Auto-Tuning	5-39
Error.....	6-11, 6-13
Parameters Affected by	B-2
Selection	A-23

kW, Converting from HP.....	5-39
kWH User Monitor Initialization	A-25

L

Lamps, Indicator – See Indicators, Mode	
Language Selection	5-2, A-2
LCD Display– See Digital Operator, Data Display	
Lights – See Indicators, Mode	
Line-borne Interference – See Interference	
Line-to-Line Resistance, Motor	5-39, A-11
LonWorks	5-3, 5-5

M

Main Circuit	
Terminals	2-2, 2-8
Test Procedure.....	6-20
Wire Sizes and Connectors	2-3 to 2-7
Wiring Diagrams	2-9, 2-10, 2-11
Main Menu	
Functions.....	3-7
Structure	3-8
Maintenance	7-1 to 7-8
Mass, Drive	1-4, 1-10
Master Frequency Reference Terminal Selection	A-16
Master/Auxiliary Switch	2-13
Master/Slave – See Modbus Communications Configuration	
Mechanical Oscillation	6-18
Mechanical Resonance	6-18
MENU Key	3-3
Menu Trees, Digital Operator	3-8
Metasys.....	iii, iv, A-18, D-1
Meters – See Analog Outputs	
Modbus Communications	A-18, D-1 to D-13
(Also see Serial Communications)	
Baud Rate.....	6-8, D-2, D-4
Terminals.....	2-13
Mode Selection	3-3
Model Number	1-4
Modified Constants Menu.....	3-7, 3-14
Molded Case Circuit Breaker (MCCB)	E-4
Momentary Power Loss Ride-thru	5-29, A-19, C-4
Monitor	
Configuration	5-21
Parameter List	3-9, A-26, A-27
Power-On Monitor	5-35, A-22
User Monitor	5-35, A-23, A-24
MONITOR Key.....	3-3
MOP (Motor Operated Pot) Function	5-36
Reference Memory	A-9

Motor

Auto-Tuning	
Fault Displays & Processing	6-12
How to	5-39
Line-to-Line Resistance	5-39, A-11
Menu.....	3-7, 3-14
Motor Rated Current	A-25
Motor Rated Power	A-25
Direction.....	4-7, 6-16
No-Load Current (NLA)	A-11
Output, Maximum Applicable – See Specifications	
Parameters	A-11
Pre-Heat Current.....	A-4
Protection.....	5-16, C-4
Overheat	A-19
Overload	A-19, C-4
Rated Current (FLA)	4-6, 5-26, 6-12, A-11
Rated Voltage	4-3
Speed (U1-02)	A-26
Stopping Method Selection	4-7, 5-5, 5-6, A-4
Temperature Input Filter Time.....	A-19
Troubleshooting.....	6-15 to 6-19
Wiring	2-13
Mounting Drive – See Installation, Physical	
Mounting, Inspecting	7-2
Multi-function Analog Inputs – See Analog Inputs	
Multi-function Analog Outputs – See Analog Outputs	
Multi-function Digital Inputs – See Digital Inputs	
Multi-function Digital Outputs – See Digital Outputs	
Multi-step Speed Reference (Preset Speed).....	2-13, A-8

N

Nameplate Information	1-3, 1-4
NEMA Type 1	1-2, 1-4, 1-5
Noise	
Electrical	2-19 to 2-21
Fan	7-2, 7-3
Filter	E-4
Mechanical.....	6-18
No-Load Current (NLA)	A-11

O

OFF Key	3-4
Function during Auto Run.....	A-24
Off-delay Timer	A-5
On-delay Timer.....	A-5
Open Chassis.....	1-2, 1-4, 1-5

Operation	
Menu	3-7, 3-9
Status (U1-12)	A-26
Operator Programming Errors (OPE).....	6-11
Option	
Card Faults	6-3, 6-4
Communication Error Selection.....	5-26
Options (Peripheral Devices)	E-4
Orientation, Drive.....	1-12
Oscillation	
Mechanical	6-18
with PI control.....	6-18
with V/f control	6-18
Output	
Current Monitor (U1-03).....	A-26
Frequency – See Frequency, Output	
Ground Fault Detection Selection.....	A-22
Monitors	A-26, A-27
Phase Loss.....	6-9
Power Monitor (U1-08).....	A-26
Power Ratings – See Specifications, Standard Drive	
Terminal Status Monitor (U1-11).....	A-26
Transistors (IGBT)	
Inspecting.....	7-2
Spare Parts	F-2, F-3
Testing.....	6-20 to 6-22
Voltage Monitor (U1-06).....	A-26
Outputs, Analog – See Analog Outputs	
Outputs, Digital – See Digital Outputs	
Over Current (OC).....	5-6, 5-30, 6-5
Overheat (OH)	
Alarms/Faults	6-9, 6-5
Cooling Fin (Heatsink).....	6-5, 6-9, C-4
Drive.....	A-22
Motor.....	6-5, 6-9, A-19
Parameters	A-19, A-22
Pre-Alarm.....	6-9, A-22
Overload	
Alarms/Faults	5-30, 6-6
Capacity.....	C-4
Drive.....	6-6
Motor.....	6-6, A-18
Overtorque – See Torque Detection	
Protection	A-19, C-4
Overtorque – See Torque Detection	
Overvoltage Protection.....	6-6, 6-9, C-4
DC Bus – See DC Bus Voltage	

P

Parameters	
Accel/Decel (C1-01 – C1-11)	A-7
Analog Inputs (H3-02 – H3-13)	A-16
Analog Outputs (H4-01 – H4-08).....	A-17, A-18
Auto-Tuning (T1-02 – T1-04)	A-25
Capacity Related.....	B-1
Carrier Freq (C6-02 – C6-05)	A-8
Com OPT Setup (F6-01 – F6-05)	A-11
COPY Function (o3-01 – o3-02)	A-25
DC Braking (b2-01 – b2-09)	A-4
Delay timers (b4-01 – b4-02)	A-5
Digital Inputs (H1-01 – H1-05).....	A-12 to A-14
Digital Outputs (H2-01 – H2-02)	A-14
Energy Saving (b8-01 – b8-06)	A-7
Example of Changing	3-15, 3-16
Factory Reset (Initialize)	A-2
Fault Restart (L5-01 – L5-03)	A-21
Hdwe Protection (L8-01 – L8-19).....	A-22
High Slip (n3-01 – n3-04)	A-23
Hunting Prevention (n1-01 – n1-02)	A-23
Initialization (A1-00 – A1-05).....	A-2
Jump Frequencies (d3-01 – d3-04).....	A-9
Key Selections (o2-01 – o2-15).....	A-24, A-25
Listing of	A-1 to A-29
Modified – See Modified Constants	
Monitor Select (o1-01 – o1-08).....	A-23, A-24
MOP/Trim Control (d4-01 – d4-02)	A-9
Motor Overload (L1-01 – L1-05)	A-19
Motor Setup (E2-01 – E2-05).....	A-11
PI Control (b5-01 – b5-30).....	A-5, A-6
Preset Reference (d1-01 – d1-17).....	A-8
Programming	5-1 to 5-40
PwrLoss Ridethru (L2-01 – L2-05).....	A-19
Ref Detection (L4-01 – L4-06).....	A-21
Reference Limits (d2-01 – d2-03)	A-9
S-Curve Acc/Dec (C2-01 – C2-02)	A-7
Sequence (b1-01 – b1-12).....	A-4
Serial Com Setup (H4-06 – H4-08).....	A-18
Setting and Reading.....	3-13
Speed Search (b3-01 – b3-05)	A-5
Stall Prevention (L3-01 – L3-06)	A-20
Torque Comp (C4-01 – C4-02).....	A-8
Torque Detection (L6-01 – L6-03)	A-21
Troubleshooting	6-14
User (A2-01 – A2-32).....	A-2, A-3
V/f Pattern (E1-01 – E1-13)	A-10
Parity – See Modbus Communications	

Parts	
Ordering Replacement	Inside Back Cover
Replacement Guidelines	7-4
Spare	F-1 to F-3
Password	
Setting	A-2
Troubleshooting	6-14
PCB	
Control	
Inspecting	7-2
Spare Parts	F-2, F-3
Gate Drive	
Inspecting	7-2
Spare Parts	F-2, F-3
Power	
Inspecting	7-2
Spare Parts	F-2, F-3
Terminal	
Inspecting	7-2
Removing and Mounting	7-7
Spare Parts	F-2, F-3
Peripheral Devices	
AC and DC reactor	E-4
Ground Fault Interrupter	E-4
Magnetic Contactor	E-4
Molded-case circuit breaker (MCCB)	E-2
Noise filter	E-4
Phase-advancing capacitor	E-4
Troubleshooting	6-17
Phase Loss Detection	
Input	6-6, A-22
Output	6-9
Phase-to-Phase Short	6-5, 6-9
Physical Installation –See Installation, Physical	
PI Feedback Loss	6-4
PI Function	
Accel/Decel Time	5-16, A-6
Block Diagram	5-8
Feedback	5-10
Differential	5-9
Loss Detection Level	5-15, A-6
Loss Detection Time	5-15, A-6
Reference Missing Detection	5-15, A-5
Square Root Function Activation	5-14, A-6
Integral Limit Setting	5-9, A-5
Integral Time Setting	5-9, A-5
Maximum Boost Time	5-17, A-6
Offset Adjustment	5-15, A-5
Output	5-10
Gain Setting	5-15, A-5
Level Selection	5-15, A-5
Limit	5-14, A-5
Square Root Monitor	5-18, A-6
Parameters	A-5, A-6
Primary Delay Time Constant	5-15, A-5
Setpoint	5-16, A-6
Boost Setting	5-17, A-6
Display Scaling	5-16, A-6
Selection	5-16, A-6
Value	5-16, A-6
Sleep	
Delay Time	5-15, A-6
Function	5-15
Function Start Level	5-15, A-6
Input Source	5-15, A-6
Snooze	
Deactivation Level	5-17, A-6
Delay Time	5-17, A-6
Feedback Level	5-18, A-6
Function	5-17
Level	5-13, A-6
Square Root Gain	5-14, A-6
PI Mode	5-9, A-5
PI Monitors	
Feedback (U1-24)	5-13, A-27
Output Square Root (U1-37)	5-18, A-27
Setpoint (U1-38)	5-13, A-27
PLC (Programmable Logic Controller)	
Serial Com. Using Modbus Protocol	D-2
Troubleshooting	6-17
Plenum Rated	1-11
Potentiometer (Connection)	2-16
Power	
Detection Filter Time	A-7
Input, +15Vdc	2-13, 2-16
Loss Ride-thru	5-26 to 5-30, A-19, C-4
Module Spare Parts	F-2, F-3
PCB	
Inspecting	7-2
Spare Parts	F-2, F-3
Supply Specifications	C-2, C-3
Power Factor Correction Capacitors	6-6
Pre-Operation Considerations	i to iv; Ch. 1, 2, 4
Preset Speeds	A-8
Preventive Maintenance	7-3

Programming	
Basic	5-1 to 5-40
Error (OPE)	6-11
Menu	3-7, 3-13
Proportional Gain (PI).....	5-13
Protective	
Functions	C-4
Structure	C-4
PWM Frequency — see Carrier Frequency	

Q

QUICK – See Quick Setting Menu	
Quick Setting Menu	3-12

R

RAM.....	D-11
Ramp to Stop	5-5
Rated Current, Motor	4-6, 5-25, 6-12, A-11
Rdy – See Ready Display	
Reactors, Preventive Maintenance	7-3
READ	5-37
Ready Display	3-2
Receiving	1-3
REF Indicator	3-4, 3-5
Reference Limits (Also see Frequency)	5-19, 6-19, A-9
Reference Selection	
AUTO.....	3-3
HAND	3-4
Reference Source.....	5-2, 5-3, A-4
Relays, Preventive Maintenance	7-3
Replacement Parts – Also see Spare Parts Ordering	Inside Back Cover
RESET Key – See SHIFT/RESET Key	
Resistance, Motor Line-to-Line	5-40, A-11
Resonance.....	5-15
REV Indicator	3-4
Reverse Operation	5-6, A-4
Prohibiting.....	5-6, 6-16, A-4
Reverse Run/Stop command	2-13, 2-16, A-4
Ride-thru, Momentary Power Loss .	5-26 to 5-31, A-19, C-4
"Right Arrow" Key – See SHIFT/RESET Key	
RS-485/422	5-4
Communication Wiring.....	D-3
Control Circuit Terminals	2-13
Parameters	A-18
Terminating Resistance	2-14, D-3
RTS Control Selection.....	A-18

Run Command	
During Program	A-4
External, Troubleshooting	6-15
Selection	3-3, 3-5, 4-6, 5-3, A-4
Source	5-3
RUN Indicator.....	3-6
Running	
Signal	2-13
Stall Prevention during	A-20

S

Scaling Display	
Digital Operator	A-23
PI Setpoint	5-16, A-6
S-Curve Characteristic	
at Accel End.....	A-7
at Accel Start.....	A-7
Search Operation Voltage Limit.....	A-7
SEQ.....	3-4, 3-5
Sequence Parameters	A-4
Serial Communications - See also Modbus Communications	
Address	D-4
Baud Rate	6-8, D-4
Drive Node Address	D-4
Parameters	A-18, D-4
Run Command.....	5-4
Self-Diagnosis Function	D-13
Serial Number	1-3
Setpoint (PI Function).....	5-16
Boost Setting.....	5-17, A-6
Display Scaling.....	5-16, A-6
Selection	5-16, A-6
Value	5-16, A-6
SHIFT/RESET Key	3-3, 5-19
Shield Wire Grounding	2-13, 2-17
Shipping Damage.....	1-3
Short Circuit Protection, Branch.....	E-2, E-3
Sinking/Sourcing Mode	2-13, 2-15, 2-16
Skip Frequency — See Jump Frequency and Frequency Limits	
Slave – See Modbus Communication Configuration	
Sleep Function – See PI Function, Sleep	
Snooze Function – See PI Function, Snooze	
Soft Charge Contactor	
Alarm	6-10
Checking.....	6-21
Fault	6-7
Preventive Maintenance	7-3

Soft Charge Resistor	
Checking	6-21
Preventive Maintenance	7-3
Soft CLA Selection	A-22
Soft Start — see S-Curve	
Software Number	A-27
Spare Parts	F-1 to F-3
SPEC	1-3, 1-4
Specifications	
Design	1-4
General	C-4
Selection	A-25
Standard Drive	
208-240Vac	C-2
480Vac	C-3
Nameplate	1-3
Speed	
Agreement	A-21
Control Accuracy	C-4
Range	C-4
Speed Command – See also Frequency Reference	
0-10Vdc	4-9
4-20mA	4-9
Limits	5-19
Loss Detection	5-30
Selection	4-6, 5-2, 5-3
Setting Selection	5-36
Signal Polarity	4-9
Troubleshooting	6-15, 6-16
Speed Reference, Multiple (Multi-step Speed Operation) – See Preset Speeds	
Speed Search	5-30
Auto-Tuning	5-39
Parameters	A-5
Stall Prevention	
Parameters	A-20
Specifications	C-4
Troubleshooting	6-16
Start-up	4-1 to 4-9
Assistance	Inside Back Cover
Benchmark data	4-8
Preparation for	4-2
Procedure	4-5
Station Address (Modbus Control)	D-4
Stop bits – See Modbus Communications	
STOP Indicator	3-6
Stop Method Selection (OH)	A-22
Stopping Method	4-7, 5-5, 5-6, A-4
Coast to Stop	5-5
Coast w/Timer	5-6

DcInj to Stop	5-6
for External Fault from OPT Card	A-11
Ramp to Stop	5-5
Stopping Method at Error (Modbus Control) – See Modbus Communications	
Storage Temperature	C-4
Surge Suppressor	E-4
Switching Frequency, Accel/Decel	5-18, 5-19, A-7

T

Technical Support	Inside Back Cover
Technical Training	Inside Back Cover
Temperature	
Ambient Operating	1-11, C-4
Ambient, Setting	A-22
Effect on Frequency Accuracy	C-4
Storage	C-4
Troubleshooting	6-17
Terminal PCB	
Inspecting	7-2
Removing and Mounting	7-7
Spare Parts	F-2, F-3
Terminals	
Terminal A1	2-13, 2-16, 5-26, A-16
Terminal A2	2-13, 2-16, 5-28, 5-29, A-16
Terminal AM	2-13, 2-16, A-17, A-18
Terminal FM	2-13, 2-16, A-17
Terminal M1-M2	2-13, 2-16, A-15
Terminal M3-M4 Function Selection	2-13, 2-16, A-15
Terminal R+, R-, S+, S-	2-13, 2-16, D-3
Terminal S1, S2	2-13, 2-16, 5-4
Terminals S3 – S7	2-13, 2-16, A-12 to A-14
Arrangement	1-6
Configuration	2-2
Connections	2-16
Control Circuit	2-12, 2-16
Main Circuit	2-3 to 2-11
Inspecting	7-2
Wiring	2-3 to 2-7
Preventive Maintenance	7-3
Screw Sizes	2-3 to 2-7
Terminating Resistance	2-14, D-3
Three-Wire Operation	5-4
Troubleshooting	6-15
Timers, Delay	A-5
Timers, Elapsed	5-36, A-25
Torque Compensation	
Parameters	A-8
Troubleshooting	6-16

Torque Detection	
Faults	6-6
Level	5-32, 5-33
Nuisance	5-20
Parameters	A-21
Selection	5-32, 5-33
Time	5-32, 5-33
Torque Output.....	6-16
Transformers, Preventive Maintenance.....	7-3
Transistor Module	
Inspecting	7-2
Resistance Test	6-20 to 6-22
Spare Parts.....	F-2, F-3
Trim Control Level	A-9
Troubleshooting	6-1 to 6-24
Two-Wire Operation.....	5-3
Troubleshooting	6-15
Twelve-pulse rectification	2-9, C-2, C-3

U

U1 Monitor List.....	3-9, A-26, A-27
U2 Fault Trace List.....	3-10, A-28
U3 Fault History List.....	3-11, A-29
UL File Number	1-3, 1-4
Undertorque Detection (UL)	5-32
Alarm/Fault	6-7, 6-10
Parameters	A-21
Undervoltage (UV)	
Alarm/Fault	6-7, 6-10
Detection Level	A-19
Protection	C-4
"Up Arrow" Key – See INCREASE Key	
Up/Down Function – See MOP	
User Initialization	5-36
User Parameter Default Value.....	5-36, A-24
User Parameters	A-2, A-3
User Monitor	5-35, 5-36, A-23

V

Ventilation – See Installation Site	
VERIFY Function	5-38
Error	5-39, 6-13
VERIFY Menu – See Modified Constants Menu	
V/f Pattern	
Faults/Errors.....	6-5, 6-11
Parameters	A-10
Vibration, Maximum	C-4

Voltage	
Allowable fluctuation	6-7, 6-10, C-2, C-3
Base	A-10
Drop Calculation.....	2-7
Input – See Input Voltage	
Maximum Output	C-2, C-3
Rating, Drive	1-4, C-2, C-3
Related Parameters	A-10

W

Warranty.....	6-24
Watchdog Timer.....	6-3
Weight – See Mass, Drive	
Wire	
Clamping Torque	2-3 to 2-7
Gauge – See Wire Size	
Length – See Cable Length	
Size	2-3 to 2-7
Wiring – See also Electrical Installation	
Control Circuit	2-12
Diagrams	2-16
Distances – See Cable Length	
Field Diagram	2-18
Ground	2-11, 2-21
Main Circuit	
Input/Output	2-9, 2-10
Terminals	2-3 to 2-7
Shielded Twisted-Pair Wires	2-17
Sinking/Sourcing	2-15
Three-Wire Control.....	2-16
Two-Wire Control	2-16

Z

Zero speed signal	A-14
-------------------------	------

P7B Drive/Bypass



YASKAWA ELECTRIC AMERICA, INC.

Drives Division
16555 W. Ryerson Rd., New Berlin, WI 53151, U.S.A.
Phone: (800) YASKAWA (800-927-5292) Fax: (262) 782-3418
Internet: <http://www.drives.com>

YASKAWA ELECTRIC AMERICA, INC.

Chicago-Corporate Headquarters
2121 Norman Drive South, Waukegan, IL 60085, U.S.A.
Phone: (800) YASKAWA (800-927-5292) Fax: (847) 887-7310
Internet: <http://www.yaskawa.com>

MOTOMAN INC.

805 Liberty Lane, West Carrollton, OH 45449, U.S.A.
Phone: (937) 847-6200 Fax: (937) 847-6277
Internet: <http://www.motoman.com>

YASKAWA ELECTRIC CORPORATION

New Pier Takeshiba South Tower, 1-16-1, Kaigan, Minatoku, Tokyo, 105-0022, Japan
Phone: 81-3-5402-4511 Fax: 81-3-5402-4580
Internet: <http://www.yaskawa.co.jp>

YASKAWA ELETRICO DO BRASIL COMERCIO LTDA.

Avenida Fagundes Filho, 620 Bairro Saude Sao Paolo-SP, Brasil CEP: 04304-000
Phone: 55-11-5071-2552 Fax: 55-11-5581-8795
Internet: <http://www.yaskawa.com.br>

YASKAWA ELECTRIC EUROPE GmbH

Am Kronberger Hang 2, 65824 Schwalbach, Germany
Phone: 49-6196-569-300 Fax: 49-6196-888-301

MOTOMAN ROBOTICS AB

Box 504 S38525, Torsas, Sweden
Phone: 46-486-48800 Fax: 46-486-41410

MOTOMAN ROBOTEC GmbH

Kammerfeldstrabe 1, 85391 Allershausen, Germany
Phone: 49-8166-900 Fax: 49-8166-9039

YASKAWA ELECTRIC UK LTD.

1 Hunt Hill Orchardton Woods Cumbernauld, G68 9LF, Scotland, United Kingdom
Phone: 44-12-3673-5000 Fax: 44-12-3645-8182

YASKAWA ELECTRIC KOREA CORPORATION

Paik Nam Bldg. 901 188-3, 1-Ga Euljiro, Joong-Gu, Seoul, Korea
Phone: 82-2-776-7844 Fax: 82-2-753-2639

YASKAWA ELECTRIC (SINGAPORE) PTE. LTD.

Head Office: 151 Lorong Chuan, #04-01, New Tech Park Singapore 556741, Singapore
Phone: 65-282-3003 Fax: 65-289-3003

TAIPEI OFFICE (AND YATEC ENGINEERING CORPORATION)

10F 146 Sung Chiang Road, Taipei, Taiwan
Phone: 886-2-2563-0010 Fax: 886-2-2567-4677

YASKAWA JASON (HK) COMPANY LIMITED

Rm. 2909-10, Hong Kong Plaza, 186-191 Connaught Road West, Hong Kong
Phone: 852-2803-2385 Fax: 852-2547-5773

BEIJING OFFICE

Room No. 301 Office Building of Beijing International Club,
21 Jianguomanwai Avenue, Beijing 100020, China
Phone: 86-10-6532-1850 Fax: 86-10-6532-1851

SHANGHAI OFFICE

27 Hui He Road Shanghai 200437 China
Phone: 86-21-6553-6600 Fax: 86-21-6531-4242

SHANGHAI YASKAWA-TONJI M & E CO., LTD.

27 Hui He Road Shanghai 200437 China
Phone: 86-21-6533-2828 Fax: 86-21-6553-6677

BEIJING YASKAWA BEIKE AUTOMATION ENGINEERING CO., LTD.

30 Xue Yuan Road, Haidian, Beijing 100083 China
Phone: 86-10-6232-9943 Fax: 86-10-6234-5002

SHOUGANG MOTOMAN ROBOT CO., LTD.

7, Yongchang-North Street, Beijing Economic & Technological Development Area,
Beijing 100076 China
Phone: 86-10-6788-0551 Fax: 86-10-6788-2878

YEA, TAICHUNG OFFICE IN TAIWAN

B1, 6F, No.51, Section 2, Kung-Yi Road, Taichung City, Taiwan, R.O.C.
Phone: 886-4-2320-2227 Fax: 886-4-2320-2239